

TRES



TRES

www.tresgriferia.com

tres exclusive

ESPACIO DUCHA / BAÑERA

Block System® 188

N Shower Technology® 254

Mono-Term® 286

Monomandos de 3 vías 296

Programa de duchas 309

Conjuntos termostáticos 339

SERIES

Slim exclusive 25

Cuadro exclusive 43

Study exclusive 55

Loft colors 75

N Project-tres 89

N Clasic 111

ACCESORIOS

Slim-tres 156

Cuadro-tres 157

Max-tres / Class-tres 158

Loft-tres 160

Clasic 162

GRIFERÍA DE COCINA

Monomando 168

Caño extraíble 175

Abatible 178

Electrónica 179

Mural 180

Bimando 182

tres selection

ESPACIO DUCHA / BAÑERA

Conjuntos termostáticos 358

Termostáticas 368

Columnas de ducha 376

Monomandos 380

Bañeras de repisa 396

Programa de duchas 543

SERIES

Cuadro-tres 403

Max-tres 419

Loft-tres 435

Class-tres 445

Lex-tres 451

Alplus 465

Flat-tres 477

K-tres 483

Bm-tres 491

Monotres 2000 497

Eco-tres 503

Ese-23 511

Temporizadas / Electrónicas 533

GRIFERÍA DE COCINA

Monomando 520

Caño extraíble 525

Para tratamiento de agua 527

Industrial 528

Mural 530

GRIFERÍA ESPECIAL

Bidé 544

Medicales 548

Peluquería 549

Cocina 549



































Jardín-Piscina 550

Vino 551

COMPLEMENTOS

Válvulas	590
Desagües	596
Sifones	598
Florones	601
Caños	602
Llaves de paso	604
Excéntricas	606
Limitadores de caudal	609
Aireadores	610
<hr/>	
Listado de referencias	613
<hr/>	
Condiciones generales de venta	622
<hr/>	
Acabados	624
<hr/>	
Instalación recomendada	626

RECAMBIOS DE LOS ARTÍCULOS EN:
www.tresgriferia.com

Slim exclusive			Cuadro-tres
Cuadro exclusive			Max-tres
Study exclusive			Loft-tres
Loft colors			Class-tres
N Project-tres			Lex-tres
N Clasic			Alplus
Accesorios			Flat-tres
Cocina Exclusive			K-tres
Block System			Bm-tres
N Shower Technology			Monotres 2000
Mono-Term			Eco-tres
3V			Ese-23
Duchas			Cocina Selection
Conjuntos termostáticos			Temporizadas / Electrónicas
Termostáticas			Grifería especial
Monomandos			Duchas
			Complementos
			Listado de referencias







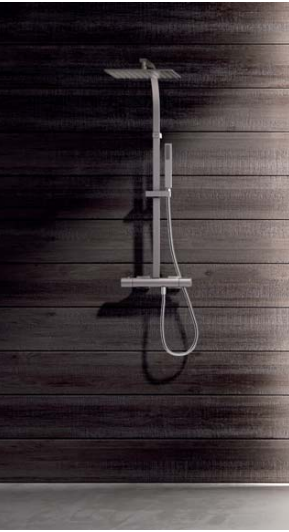

ES LA HORA DE LA DUCHA

Uno busca en su baño aquel oasis para relajarse y pensar en uno mismo y, por qué no decirlo, también para compartir mañanas ajetreadas, refrescarse o arreglarse antes de salir.

El baño ha dejado de ser un lugar únicamente funcional para convertirse en un espacio donde el bienestar debe estar presente. **Cuando uno entra en su ducha no quiere complejas instrucciones, quiere que todo le resulte fácil, intuitivo, seguro y eficiente.** Sólo reclamamos ese placer que te da el agua cayendo por tu espalda, la lluvia de gotas que resbalan por tu cabeza y la garantía que ese momento es tu momento.

Porque la hora de la ducha debe ser el mejor momento del día.





LA DUCHA QUE MEJOR TE SIENTA

■ MONOMANDOS

Con diseños adaptables y muchas posibilidades, es una opción simple y sumamente funcional para un gran placer en la ducha.

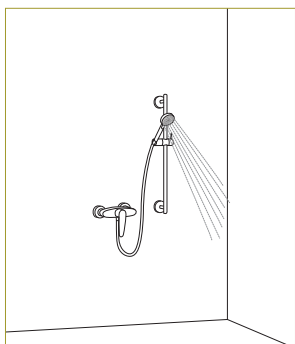

Conjuntos de superficie.

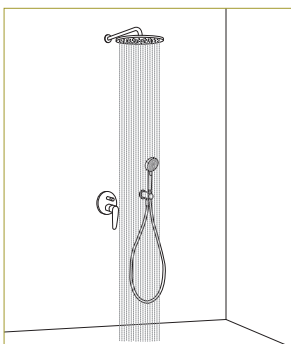

Conjuntos empotrados.

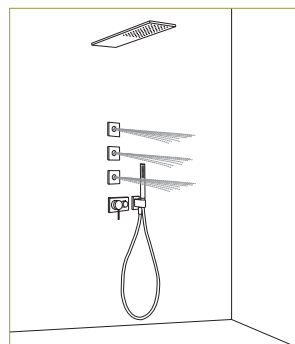

Conjuntos empotrados de 3 vías.

■ MONO-TERM®

La funcionalidad de los monomandos pero con un cartucho revolucionario que ofrece el confort similar de una termostática.

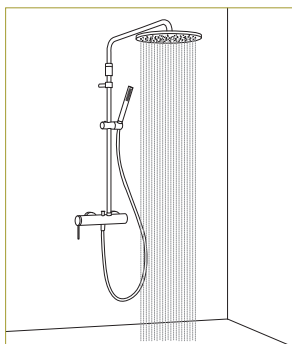

Conjuntos de superficie.

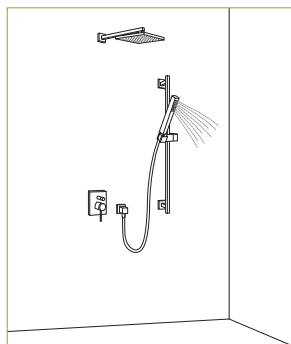

Conjuntos empotrados.

Antes de planificar tu **espacio de ducha o bañera** debes elegir qué concepto de grifería será más idóneo. Este esquema te ayudará a detectar rápidamente cuál es tu tipo de ducha ideal.

■ TERMOSTÁTICAS

El control máximo de la temperatura y de la ducha. Las mayores prestaciones con distintos formatos, diseños y funcionalidades.

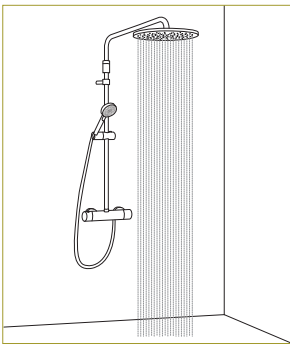

Termostáticas de superficie.

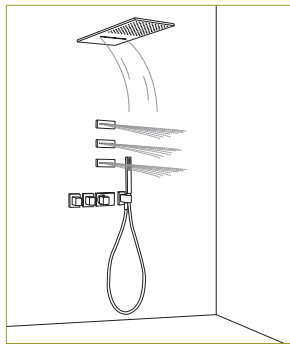

Conjuntos empotrados con varias funciones.

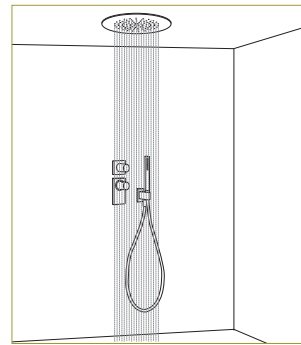

Conjuntos empotrados de techo.

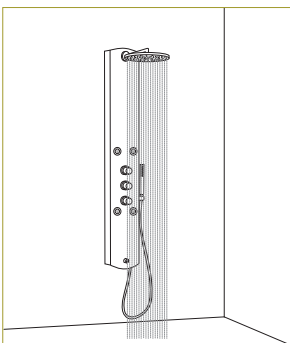

Columnas de ducha multifunciones.

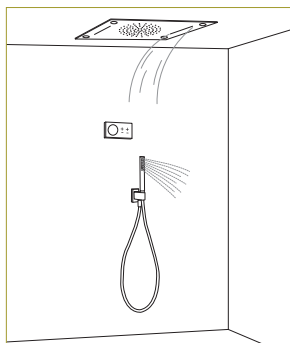

Conjuntos con control digital electrónico.

COMPARADOR DE TECNOLOGÍAS



MONOMANDOS

Una solución sencilla y de fácil instalación con diferentes diseños y formas que se adaptan a cualquier espacio. Los monomandos destacan por su funcionalidad, un manejo cómodo desde un solo mando y alta resistencia al paso del tiempo.



MONO-TERM®

Mono-Term® es un sistema único y revolucionario ideado por Tres que marca el futuro en la fabricación de grifería. La funcionalidad es como la de los monomandos pero ofrece un confort similar a las de una termostática: mantiene la temperatura constante, bajo nivel acústico y seguridad.



TERMOSTÁTICAS

Control total de la temperatura, con cartuchos que garantizan un caudal de agua constante, con inversor integrado en el regulador de caudal y de diseños diversos con diferentes funciones y prestaciones.



Presentamos las tecnologías más avanzadas que TRES ha desarrollado para disfrutar de la mejor experiencia en la ducha.



BLOCK-SYSTEM®

Termostáticas empotradas de gran simplicidad y belleza, con control preciso de la temperatura e infinidad de combinaciones. Además, el sistema block system se caracteriza por su simplicidad en la instalación y alineación de los elementos.



SHOWER TECHNOLOGY®

A través del control electrónico digital se selecciona la temperatura y las diferentes salidas del agua de manera fácil e intuitiva para crear una experiencia única y personal. La centralita termostática se puede instalar en cualquier parte de la vivienda.



COLUMNAS DE DUCHA

En un sólo sistema se integra el rociador, la ducha de mano y los jets de hidromasaje para aprovechar las máximas prestaciones de un producto termostático que ofrece la oportunidad de disfrutar del relax y el agua en estado puro.

CUANDO EL DISEÑO ES MÁS QUE UNA FORMA BONITA

Abrir un grifo para lavarse las manos o los dientes es un gesto fácil, pero para llegar aquí hay un trabajo de diseño que pone el foco en su ingeniería. Y es que el diseño es mucho más que buscar una forma bonita y moderna. **Las reglas principales que debe cumplir un grifo son su funcionalidad** (que nos hagan la vida más sencilla), **que sea estéticamente adecuado** (que encaje en tu espacio) **y fabricado con materiales de calidad** (garantía de durabilidad, eficiencia y salud). Un grifo de lavabo es para toda la vida; y un diseño inteligente es la clave.



EL LAVABO ES LA CLAVE

La altura y forma del lavamanos, así como el diseño del baño, influyen en la elección del grifo de lavabo ideal. Cuando el fondo es tan importante como la forma, el diseño inteligente de los grifos TRES se centra tanto en el cuerpo como en el propio corazón del grifo. Para que tu elección tenga la mejor garantía.



EL CUERPO DEL GRIFO

[MATERIAL Y ACABADO]

Fabricado con **latón** de aleación CB755S, con bajo nivel de plomo, cumpliendo con la normativa Europea.

Cromado de gran resistencia. El cromado Tres-Micron® es duradero y fácil de limpiar.

EL CORAZÓN DEL GRIFO

[CARTUCHO]

Sistema antiquemaduras **Protec-Tres®**. El anillo del cartucho permite limitar la temperatura máxima deseada.

Discos cerámicos. Funcionamiento suave del mando con una larga vida útil del cartucho. En TRES este sistema es de tipo embrague y está patentado.

¡DEJA QUE FLUYA!



Maneras distintas de dejar caer el agua, como una cascada o con aireador.

ADÁPTALO A CADA AMBIENTE

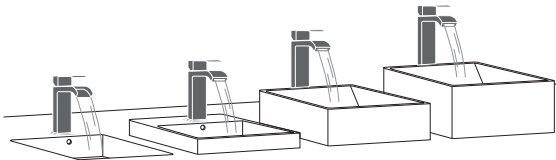

Grifos de lavabo convencionales para lavamanos de encimera o con cuerpos más altos para lavamanos de sobre encimera de distintas alturas.

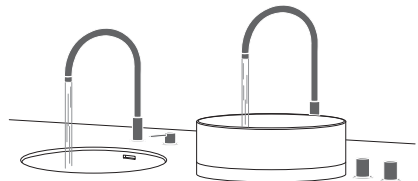

El mando de los grifos de repisa se instala por separado del caño, donde sea más cómodo para su uso. También con distintas alturas.

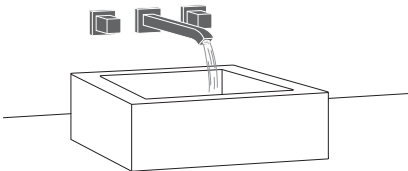

La grifería mural libera el espacio de la encimera, ofrece más longitud del caño y adaptabilidad en la altura.

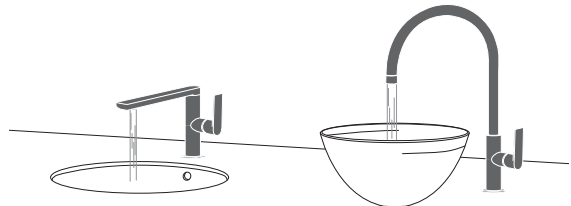

Grifos de lavabo, monomandos o bimanos, con caños de diferente altura y distancia, ideales para encimeras especiales.

MOMENTOS CREATIVOS PARA SACAR LO MEJOR DE TI

A nadie le gusta complicarse la vida y, cuando entras en una cocina, quieres que todo funcione cuando lo necesitas. El grifo de la cocina no sirve únicamente para lavar los platos, también sirve **para dar rienda suelta a tu creatividad cuando cocinas**. Llenar una olla o limpiar los utensilios que vas utilizando son actos que deben resultar fáciles y cómodos para poder centrarte en la creación de tu nuevo plato. Según tu día a día en la cocina, debes escoger las funciones que se adapten a tus usos habituales. Porque hay cocinas para todos los gustos.





COCINAS PARA TODOS LOS GUSTOS

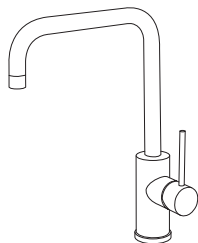

MONOMANDO

Con un cartucho de gran suavidad y un bajo nivel acústico que permite la apertura en agua fría.

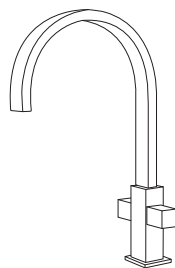

BIMANDO

El control con dos mandos o volantes independientes, uno para el agua fría y otro para la caliente.

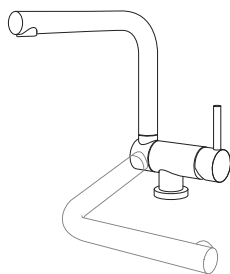

ABATIBLE

Ideal para instalaciones frente a ventanas o armarios. El grifo rota y se tumba cuando es necesario.

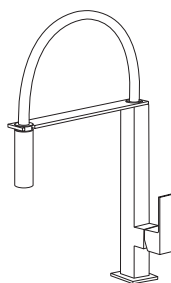

EXTRAÍBLE

La ducha y el caño extraíbles permiten ampliar la zona de trabajo de 50 a 70 cm.

Un grifo de cocina se debe adaptar a tus necesidades. Selecciona la funcionalidad que te ayude más en tu día a día en la cocina.

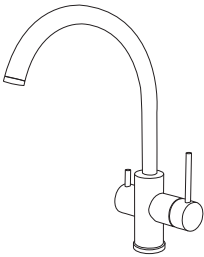

TRATAMIENTO DE AGUA

Agua filtrada sin cloro en la cocina con un mismo caño y dos conducciones distintas. También para sistemas de osmosis.

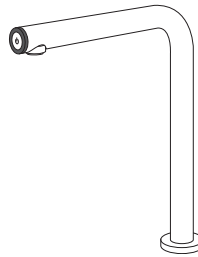

ELECTRÓNICA

Garantiza un mayor nivel de higiene, confort y seguridad. Ideal para hospitales, hoteles, restaurantes...

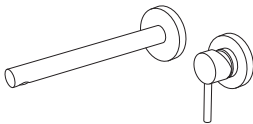

GRIFERÍA MURAL

Combinan autenticidad, calidad y minimalismo en las formas, con distintas longitudes de caño.

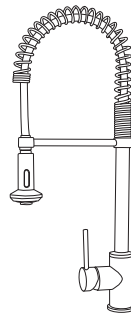

INDUSTRIAL

Facilitan el trabajo en la cocina ya que incorporan una salida elevada y giratoria, garantizando la libertad de movimiento.

TRES ESTÁ A TU LADO

En la página web de TRES podrás encontrar todos los artículos con la información relacionada (medidas, manuales, recambios, características...). Además, podrás conocer más sobre los productos a través de sus vídeos o catálogos y descubrir consejos de instalación y noticias que te ayudarán a conocer tu grifería y el mundo de TRES.



SÓLO PARA PROFESIONALES:

Desde esta página, los clientes de TRES pueden acceder al **área profesional para clientes**, que permite realizar compras online y ver todas las informaciones sobre los pedidos.

RECAMBIOS DE TODOS LOS ARTÍCULOS

Si estás buscando un recambio para uno de nuestros productos accede a nuestra web y encontrarás fácilmente todos los recambios disponibles de los artículos.



NEWSLETTER

Puedes estar al día de las novedades de TRES suscribiéndote a la **NEWSLETTER** mensual, con útiles consejos sobre grifería, noticias sobre la empresa, productos imprescindibles y la tecnología que debes conocer. TRES está a tu lado.

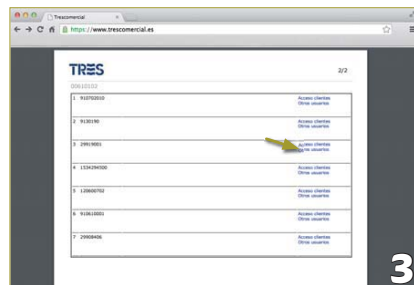
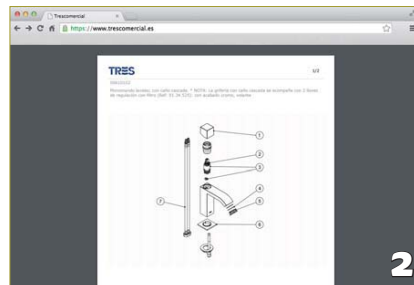
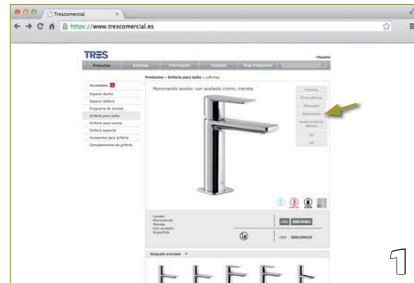





TRES EXCLUSIVE

SLIM EXCLUSIVE

- 
- 26 Lavabos
 - 29 Bidé
 - 29 Monomandos de superficie
 - 31 Monomandos empotrados
 - 35 Bañeras de repisa
 - 36 Termostáticas de superficie
 - 39 Termostáticas empotradas
 - 41 Termostáticas electrónicas empotradas
 - 153 Accesorios

RECAMBIOS DE LOS ARTÍCULOS EN:
www.tresgriferia.com

Monomando lavabo

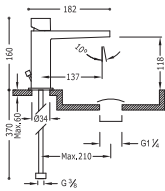

Cr | 202.103.02

91.30.190

Cr | 202.103.02.D

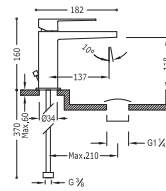

Cr | 202.103.01

91.30.190

Cr | 202.103.01.D

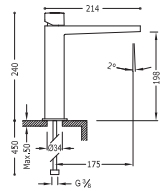

Cr | 202.103.04

91.30.190

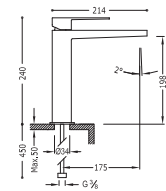

Cr | 202.103.03

91.30.190

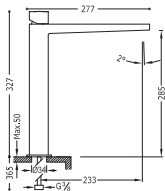

Cr | 202.103.06

91.30.190

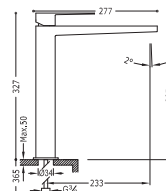

Cr | 202.103.05

91.30.190



Monomando lavabo



91.30.190

202.103.01.NE.D

202.103.01.BL.D

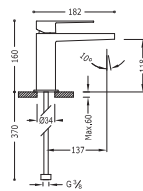

91.30.190

AC 202.103.01.AC.D

NM 202.103.01.NM.D

BM 202.103.01.BM.D

91.30.190

202.103.03.NE.D

202.103.03.BL.D

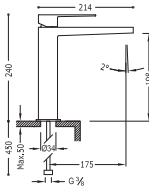

91.30.190

AC 202.103.03.AC.D

NM 202.103.03.NM.D

BM 202.103.03.BM.D

91.30.190

202.103.05.NE.D

202.103.05.BL.D

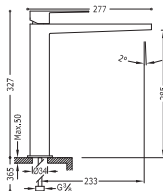

91.30.190

AC 202.103.05.AC.D

NM 202.103.05.NM.D

BM 202.103.05.BM.D

Monomando lavabo

con caño cascada libre. **NOTA:** La grifería con caño cascada se acompaña con 2 llaves de regulación con filtro (Ref: 91.34.525).

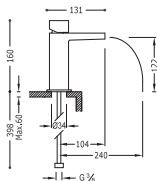

Cr	91.30.190	
	202.110.02	

	91.30.190	
	202.110.02.NED	
	202.110.02.BLD	

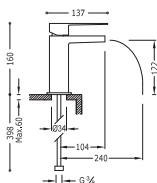

Cr	91.30.190	
	202.110.01	

	91.30.190	
	202.110.01.NED	
	202.110.01.BLD	

Monomando mural

Cuerpo empotrado incluido e indivisible.

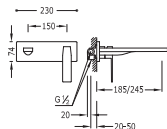

		(185 mm.)
Cr	91.30.190	
	202.200.03	

		(245 mm.)
Cr	91.30.190	
	202.200.04	

Monomando mural

Cuerpo empotrado incluido e indivisible.

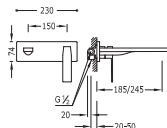

		(185 mm.)
AC	91.30.190	
	202.200.03.AC	
NM	202.200.03.NM	
BM	202.200.03.BM	

		(245 mm.)
AC	91.30.190	
	202.200.04.AC	
NM	202.200.04.NM	
BM	202.200.04.BM	



BIDÉ

Ref.:

Monomando bidé

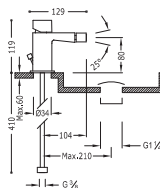

91.30.190
Cr | 202.120.02

91.30.190
Cr | 202.120.02.D

91.30.190
Cr | 202.120.01

91.30.190
Cr | 202.120.01.D

91.30.190
202.120.01.NE.D
202.120.01.BLD

91.30.190
Ac | 202.120.01.AC.D
NM | 202.120.01.NM.D
BM | 202.120.01.BM.D

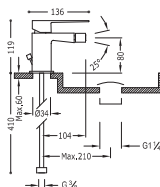

MONOMANDOS DE SUPERFICIE

Monomando ducha

Ducha de mano anticalcárea (202.639.01) con soporte orientable y flexo.

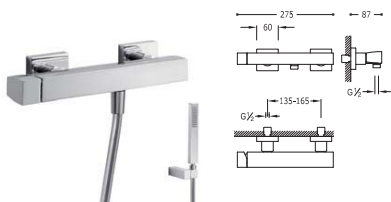

91.30.190
Cr | 202.167.01

Monomando ducha

Ducha de mano anticalcárea con soporte orientable y flexo.

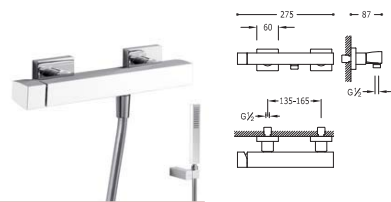

91.30.190
202.167.01.NE
202.167.01.BL

Monomando ducha

Ducha de mano anticalcárea con soporte orientable y flexo.

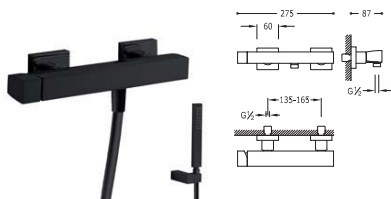

91.30.190
Ac | 202.167.01.AC

91.30.190
NM | 202.167.01.NM
BM | 202.167.01.BM

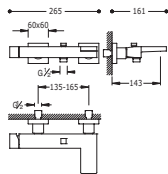

Monomando bañera-ducha

Ducha de mano anticalcárea (202.639.01) con soporte orientable y flexo.

91.30.190	REGARDA
Cr	202.170.01

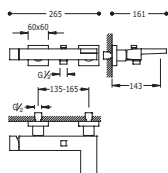

Monomando bañera-ducha

Ducha de mano anticalcárea con soporte orientable y flexo.

91.30.190	REGARDA
■	202.170.01.NE
■	202.170.01.BL

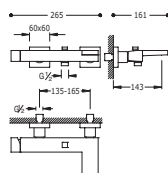

Monomando bañera-ducha

Ducha de mano anticalcárea con soporte orientable y flexo.

91.30.190	REGARDA
AC	202.170.01.AC

91.30.190	REGARDA
NM	202.170.01.NM
BM	202.170.01.BM

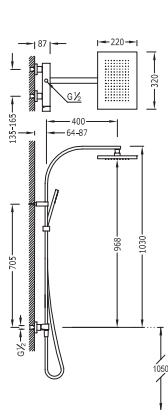

Conjunto monomando ducha anticalcárea

- Ducha fija 320x220 mm. con rótula. (299.632.02).
- Ducha móvil anticalcárea (202.639.01).
- Flexo.

91.30.190	REGARDA
Cr	202.191.01



Ref: |

N

Conjunto monomando ducha anticalcárea

- Ducha fija 320x220 mm. con rótula.
- Ducha móvil anticalcárea.
- Flexo.

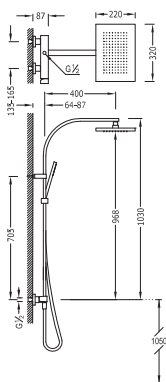

91.30.190	
AC	202.191.01.AC
NM	202.191.01.NM
BM	202.191.01.BM

MONOMANDOS EMPOTRADOS

Monomando empotrar (1 vía)

cuerpo empotrado incluido

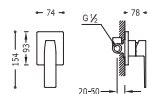

91.30.190	BELOGORA	
Cr	202.177.02	

91.30.190	BELOGORA	
Cr	202.177.01	

Monomando empotrar (2 vías)

cuerpo empotrado incluido

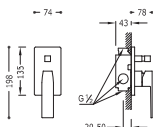

91.30.190	BELOGORA	
Cr	202.180.02	

91.30.190	BELOGORA	
Cr	202.180.01	

Kit de ducha monomando empotrado

con cierre y regulación de caudal.

- Cuerpo empotrado incluido
- Soporte con toma pared (006.182.01).
- Ducha móvil anticalcárea (202.639.01).
- Flexo.

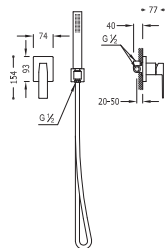

91.30.190	BELOGORA	
Cr	202.177.03	

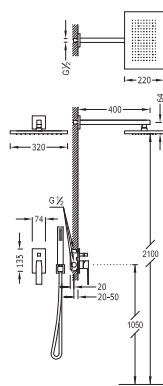

Kit de ducha monomando empotrado

- con cierre y regulación de caudal.
- Cuerpo empotrado incluido
- Ducha fija 320x220 mm. con rótula. Material Latón (299.632.02).
- Soporte con toma pared (006.182.01).
- Ducha móvil anticalcárea (202.639.01).
- Flexo.



91.30.190	REGARDA
Cr	202.180.06

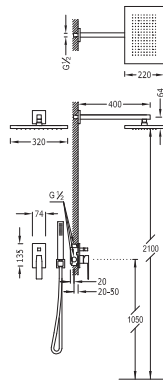

Kit de ducha monomando empotrado

- con cierre y regulación de caudal.
- Cuerpo empotrado incluido
- Ducha fija 320x220 mm. con rótula. Material Latón.
- Soporte con toma pared.
- Ducha móvil anticalcárea.
- Flexo.



91.30.190	REGARDA
■	202.180.06.NE
■	202.180.06.BL

N

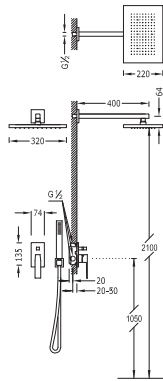

Kit de ducha monomando empotrado

- con cierre y regulación de caudal.
- Cuerpo empotrado incluido
- Ducha fija 320x220 mm. con rótula. Material Latón.
- Soporte con toma pared.
- Ducha móvil anticalcárea.
- Flexo.



91.30.190	REGARDA
■	202.180.06.AC
■	202.180.06.NM
■	202.180.06.BM



Ref: |



Kit de ducha monomando empotrado

con cierre y regulación de caudal.

- Cuerpo empotrado incluido
- Ducha fija 320x220 mm. con rúta. Material Latón (299.632.02).
- Soporte con toma pared (006.182.01).
- Ducha móvil anticalcárea (202.639.01).
- Flexo.

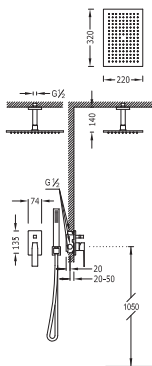

91.30.190 BELARUSA
Cr | 202.180.80



Kit de ducha monomando empotrado

con cierre y regulación de caudal.

- Cuerpo empotrado incluido
- Rociador ducha INOX a pared 160x550 mm. (299.903.03).
- Soporte con toma pared (006.182.01).
- Ducha móvil anticalcárea (202.639.01).
- Flexo.

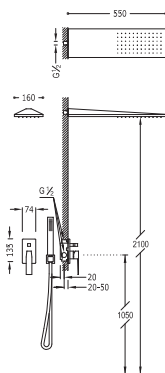

91.30.190 BELARUSA
Cr | 202.180.03



Kit de ducha monomando empotrado

con cierre y regulación de caudal.

- Cuerpo empotrado incluido
- Rociador ducha INOX a pared 160x550 mm.
- Soporte con toma pared.
- Ducha móvil anticalcárea.
- Flexo.

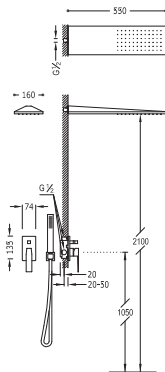

91.30.190 BELARUSA
Ac | 202.180.03.AC

91.30.190
NM | 202.180.03.NM | N
BM | 202.180.03.BM | N

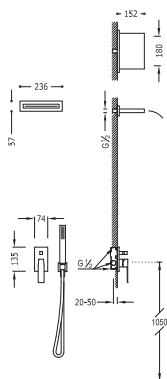
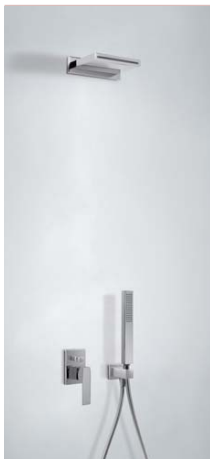

Kit de ducha monomando empotrado

- con cierre y regulación de caudal.
- Cuerpo empotrado incluido
- Ducha INOX con cascada 152x200 mm.
- Soporte con toma pared (006.182.01).
- Ducha móvil anticalcárea (202.639.01).
- Flexo.



91.30.190
Cr 202.180.05

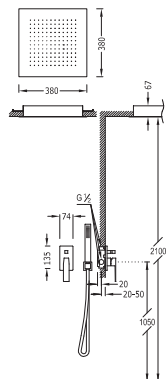

Kit de ducha monomando empotrado

- con cierre y regulación de caudal.
- Cuerpo empotrado incluido
- Rociador ducha INOX a techo 380x380 mm. (1.34.944).
- Soporte con toma pared (006.182.01).
- Ducha móvil anticalcárea (202.639.01).
- Flexo.



91.30.190
Cr 202.980.01

N

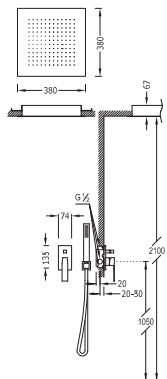

Kit de ducha monomando empotrado

- con cierre y regulación de caudal.
- Cuerpo empotrado incluido
- Rociador ducha INOX a techo 380x380 mm.
- Soporte con toma pared.
- Ducha móvil anticalcárea.
- Flexo.



91.30.190
AC 202.980.01.AC
NM 202.980.01.NM
BM 202.980.01.BM



Ref: | |

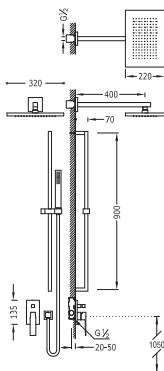

Kit de ducha monomando empotrado

- con cierre y regulación de caudal.
- Cuerpo empotrado incluido
- Ducha fija 320x220 mm. con rótula. (299.632.02).
- Barra deslizante long. 900 mm. (1.34.520).
- Codo toma pared (006.182.01).
- Ducha móvil anticalcárea (202.639.01).
- Flexo.



91.30.190
Cr | 202.180.07 |

BAÑERAS DE REPISA

Monomando bañera de repisa

- con ducha anticalcárea.
- Caudal: 3 bar - 13 l/m.
- NOTA: ver longitud caño.

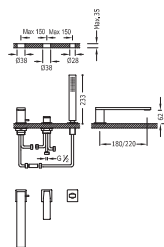

91.30.190 (180 mm.)
Cr | 202.161.04 |

91.30.190 (220 mm.)
Cr | 202.161.02 |

91.30.190 (180 mm.)
Cr | 202.161.03 |

91.30.190 (180 mm.)
Ac | 202.161.03.AC |

91.30.190 (180 mm.)
NM | 202.161.03.NM |
BM | 202.161.03.BM |

91.30.190 (220 mm.)
Cr | 202.161.01 |

91.30.190 (220 mm.)
Ac | 202.161.01.AC |

91.30.190 (220 mm.)
NM | 202.161.01.NM |
BM | 202.161.01.BM |



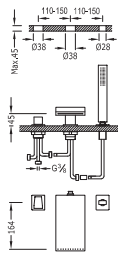

Monomando bañera de repisa
 con caño cascada y ducha móvil anticalcárea (202.639.01).
 · Caudal: 3 bar – 13 l/m.
 · Compatible con el kit depósito ref: 202.245.01.

91.30.190	BELEGRA	
Cr	202.661.02	
91.30.190	BELEGRA	
Cr	202.661.01	

TERMOSTÁTICAS DE SUPERFICIE

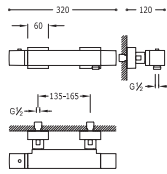

Ducha termostática
 Ducha de mano anticalcárea (202.639.01) con soporte orientable y flexo.



91.06.161.10	BELEGRA	
Cr	202.164.09	

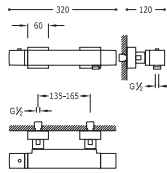

Ducha termostática
 Ducha de mano anticalcárea con soporte orientable y flexo.



91.06.161.16	BELEGRA	
91.06.161.14		
NM	202.164.09.NE	
BM	202.164.09.BL	

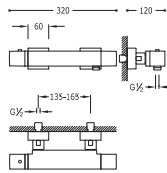

Ducha termostática
 Ducha de mano anticalcárea con soporte orientable y flexo.



91.06.161.53	BELEGRA	
AC	202.164.09.AC	

NM	91.06.161.10.NM	
BM	91.06.161.10.BM	
NM	202.164.09.NM	
BM	202.164.09.BM	

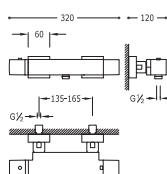

Bañera-ducha termostática
 con cascada. Ducha de mano anticalcárea (202.639.01) con soporte orientable y flexo.



91.06.161.10	BELEGRA	
Cr	202.174.09	



Ref: |

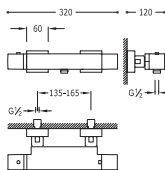

Bañera-ducha termostática

con cascada. Ducha de mano anticalcárea con soporte orientable y flexo.



91.06.161.16	91.06.161.14	REGULADOR
202.174.09.NE		
202.174.09.BL		

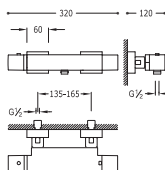

Bañera-ducha termostática

con cascada. Ducha de mano anticalcárea con soporte orientable y flexo.



91.06.161.53	REGULADOR
Ac	202.174.09.AC

NM	91.06.161.10.NM		N
BM	91.06.161.10.BM		
NM	202.174.09.NM		
BM	202.174.09.BM		

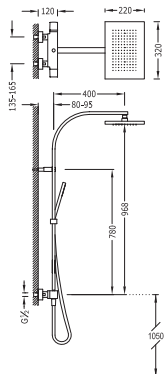

Conjunto ducha termostática

- Ducha fija 320x220 mm. con rótula. Material Latón (299.632.02).
- Ducha móvil anticalcárea (202.639.01)
- Flexo.
- Inversor integrado en el regulador de caudal.



91.06.161.10	REGULADOR
Cr	202.195.01

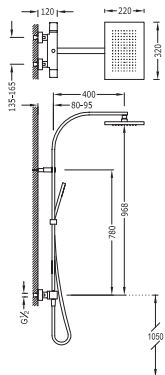

Conjunto ducha termostática

- Ducha fija 320x220 mm. con rótula. Material Latón.
- Ducha móvil anticalcárea.
- Flexo.
- Inversor integrado en el regulador de caudal.



91.06.161.16	91.06.161.14	REGULADOR
202.195.01.NE		
202.195.01.BL		

N

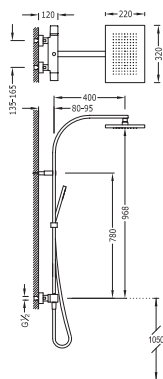

Conjunto ducha termostática

- Ducha fija 320x220 mm. con rótula. Material Latón.
- Ducha móvil anticalcárea.
- Flexo.
- Inversor integrado en el regulador de caudal.

Ac	91.06.161.153
NM	91.06.161.10.NM
NM	91.06.161.10.BM
AC	202.195.01.AC
NM	202.195.01.NM
BM	202.195.01.BM



Conjunto ducha termostática

- Ducha fija 320x220 mm. con rótula. Material Latón (299.632.02).
- Ducha móvil anticalcárea (202.639.01).
- Flexo.

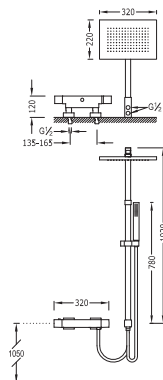

Cr	91.06.161.10
Cr	202.385.01



Conjunto bañera-ducha termostática

- Ducha fija 320x220 mm. con rótula. Material Latón (299.632.02).
- Ducha móvil anticalcárea (202.639.01).
- Flexo.
- Barra telescópica.

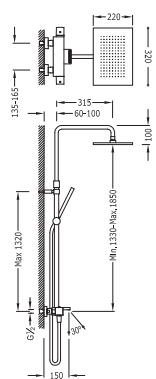

Cr	299.312.01
Cr	202.312.01





Ref: |

Conjunto bañera-ducha termostática

- Ducha fija 320x220 mm. con rótula. Material Latón (299.632.02).
- Ducha móvil anticalcárea (202.639.01).
- Flexo.

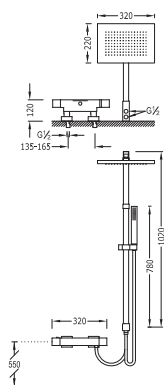

91.06.161.10
Cr | 202.385.02

TERMOSTÁTICAS EMPOTRADAS

Kit de ducha termostático empotrado BLOCK SYSTEM

- con cierre y regulación de caudal (2 vías).
- Cuerpo empotrado termostático incluido.
- Rociador ducha INOX a pared 210x550 mm. (299.903.02).
- Ducha móvil anticalcárea (202.639.01).
- Flexo SATIN (91.34.609.15).

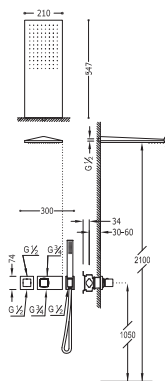

299.250.45
Cr | 207.252.02



Kit de ducha termostático empotrado BLOCK SYSTEM

- con cierre y regulación de caudal (2 vías).
- Cuerpo empotrado termostático incluido.
- Rociador ducha INOX a pared 210x550 mm.
- Ducha móvil anticalcárea.
- Flexo.

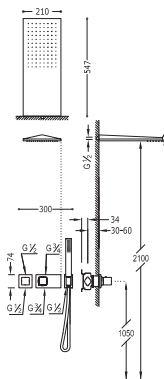

	299.250.45.NE 299.250.45.BL	
	207.252.02.NE	
	207.252.02.BL	



Kit de ducha termostático empotrado BLOCK SYSTEM

- con cierre y regulación de caudal (2 vías).
- Cuerpo empotrado termostático incluido.
- Rociador ducha INOX a pared 210x550 mm.
- Ducha móvil anticalcárea.
- Flexo.

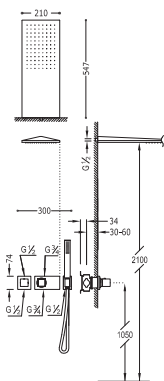

	299.250.45.AC	
	AC 207.252.02.AC	



	NM 299.250.45.NM BM 299.250.45.BM	
	NM 207.252.02.NM	
	BM 207.252.02.BM	



**Kit electrónico de ducha termostático empotrado
SHOWER TECHNOLOGY**

- Control electrónico incluido.
- Centralita termostática electrónica incluida (2 vías).
- Rociador ducha INOX a pared 210x550 mm. (299.903.02).
- Soporte con toma pared (207.182.01).
- Ducha móvil anticalcárea (202.639.01).
- Flexo SATIN (91.34.609.15).

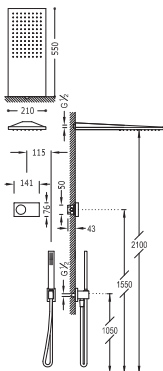

	Cr	092.865.51	
	Cr	092.885.51	







TRES EXCLUSIVE

CUADRO EXCLUSIVE

- 44 Lavabos
- 49 Bidé
- 49 Monomandos de superficie
- 50 Monomandos empotrados
- 51 Bañeras de repisa
- 51 Termostáticas de superficie
- 53 Termostáticas empotradas
- 153 Accesorios

RECAMBIOS DE LOS ARTÍCULOS EN:
www.tresgriferia.com

LAVABOS

Ref.:

Monomando lavabo

con caño cascada. NOTA: La grifería con caño cascada se acompaña con 2 llaves de regulación de filtro (Ref: 91.34.525).



299.190.01

- 006.101.01.NE.D
- 006.101.01.BLD

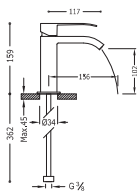

299.190.01

- AC 006.101.01.ACD
- NM 006.101.01.NM.D
- BM 006.101.01.BM.D



299.190.01

- 006.610.01.NE.D
- 006.610.01.BLD

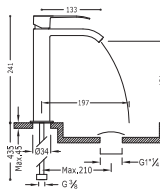

299.190.01

- AC 006.610.01.ACD
- NM 006.610.01.NM.D
- BM 006.610.01.BM.D



299.190.01

- 006.810.01.NE.D
- 006.810.01.BLD

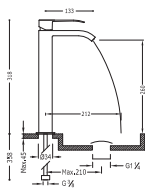

299.190.01

- AC 006.810.01.ACD
- NM 006.810.01.NM.D
- BM 006.810.01.BM.D

Monomando lavabo

con caño cascada libre. **NOTA:** La grifería con caño cascada se acompaña con 2 llaves de regulación con filtro (Ref: 91-34.525).

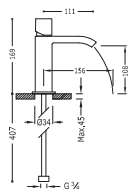

299.190.02

■	006.110.02.NE.D
■	006.110.02.BL.D

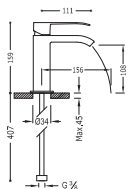

299.190.02

■	006.110.01.NE.D
■	006.110.01.BL.D

Monomando lavabo

con caño cascada. **NOTA:** La grifería con caño cascada se acompaña con 2 llaves de regulación con filtro (Ref: 91-34.525).

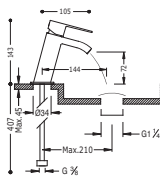

299.190.01

■	006.201.01.NE.D
■	006.201.01.BL.D

299.190.01

AC	006.201.01.AC.D
NM	006.201.01.NM.D
BM	006.201.01.BM.D

Monomando lavabo
caño de 34x10 mm.

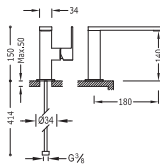

			360° 91.30.190
AC	006.205.01.ACD		
NM	006.205.01.NM.D		
BM	006.205.01.BM.D		

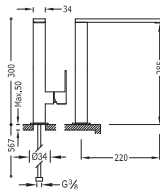

			360° 91.30.190
AC	006.485.01.ACD		
NM	006.485.01.NM.D		
BM	006.485.01.BM.D		



Monomando lavabo
caño de 22x22 mm.

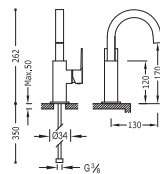

			360° 91.30.190
AC	006.605.02.ACD		
NM	006.605.02.NM.D		
BM	006.605.02.BM.D		

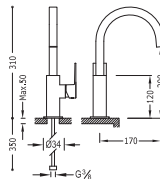

			360° 91.30.190
AC	006.606.02.ACD		
NM	006.606.02.NM.D		
BM	006.606.02.BM.D		

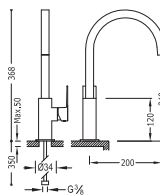

			360° 91.30.190
AC	006.607.02.ACD		
NM	006.607.02.NM.D		
BM	006.607.02.BM.D		

Monomando lavabo de repisa
De instalación libre. Caño de 22x22 mm.

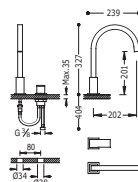

360° 91.30.190

AC	006.105.03.AC	
NM	006.105.03.NM	N
BM	006.105.03.BM	N

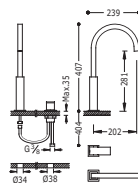

360° 91.30.190

AC	006.105.04.AC	
NM	006.105.04.NM	N
BM	006.105.04.BM	N

Bimando de repisa
De instalación libre. Caño de 22x22 mm.

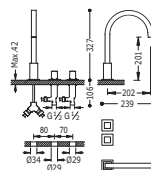

360° 91.34.282

AC	008.105.03.AC	
NM	008.105.03.NM	N
BM	008.105.03.BM	N

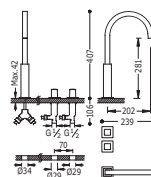

360° 91.34.282

AC	008.105.04.AC	
NM	008.105.04.NM	N
BM	008.105.04.BM	N

Bimando de repisa

De instalación libre. Caño 35x15 mm. con aireador rectangular oculto.

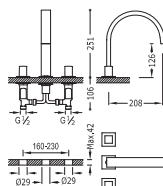

		91.34.282
AC	008.105.01.AC	
NM	008.105.01.NM	
BM	008.105.01.BM	

Grifo lavabo 1 agua o premezclada

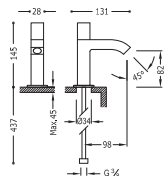

		91.08.295.10
AC	007.503.01.AC	
NM	007.503.01.NM	
BM	007.503.01.BM	

Monomando mural

Cuerpo empotrado incluido e indivisible.

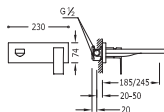

		(185 mm.)
AC	006.200.03.AC	
NM	006.200.03.NM	
BM	006.200.03.BM	

		(245 mm.)
AC	006.200.04.AC	
NM	006.200.04.NM	
BM	006.200.04.BM	

Monomando mural

Cuerpo empotrado incluido e indivisible.

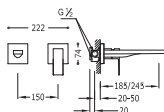

		(185 mm.)
AC	006.200.12.AC	
NM	006.200.12.NM	
BM	006.200.12.BM	

		(245 mm.)
AC	006.200.11.AC	
NM	006.200.11.NM	
BM	006.200.11.BM	

Bimando mural

Cuerpo empotrado incluido e indivisible.

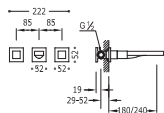

		(180 mm.)
AC	008.153.01.AC	
NM	008.153.01.NM	
BM	008.153.01.BM	

		(240 mm.)
AC	008.154.01.AC	
NM	008.154.01.NM	
BM	008.154.01.BM	

Monomando bidé

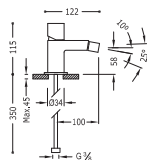

91.30.190		
	007.120.01.NE.D	
	007.120.01.BLD	

91.30.190		
AC	007.120.01.AC.D	

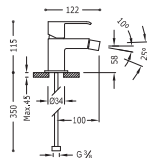

91.30.190		
	006.120.01.NE.D	
	006.120.01.BLD	

91.30.190		
AC	006.120.01.AC.D	
NM	006.120.01.NM.D	
BM	006.120.01.BM.D	

N

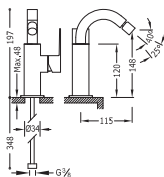

Monomando bidé

300 + 91.30.190		
AC	006.124.02.AC.D	
NM	006.124.02.NM.D	
BM	006.124.02.BM.D	

MONOMANDOS DE SUPERFICIE

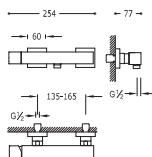

Monomando ducha

Ducha de mano anticálcaea con soporte orientable y flexo.

91.30.190	REINER	
	6.07.167	
	4.07.167	

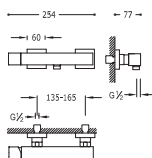

Monomando ducha

Ducha de mano anticálcaea con soporte orientable y flexo.

91.30.190	REINER	
AC	5.07.167.03	

91.30.190		
NM	007.167.03.NM	
BM	007.167.03.BM	

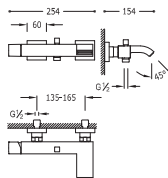

Monomando bañera-ducha

con cascada. Ducha de mano anticalcárea con soporte orientable y flexo.



91.30.190	REGADORA	
	6.07.170.02	
	4.07.170.02	

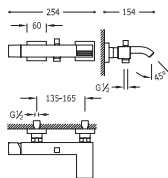

Monomando bañera-ducha

con cascada. Ducha de mano anticalcárea con soporte orientable y flexo.



91.30.190	REGADORA	
Ac	5.07.170.02.03	

91.30.190		
NM	007.170.02.03.NM	N
BM	007.170.02.03.BM	N

MONOMANDOS EMPOTRADOS

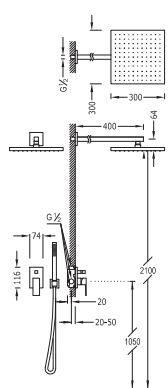

Kit de ducha monomando empotrado

- con cierre y regulación de caudal.
- Cuerpo empotrado incluido
- Ducha fija 300x300 mm. con rótula. Material Latón.
- Soporte con toma pared.
- Ducha móvil anticalcárea.
- Flexo.



91.30.190	REGADORA	
	6.06.980	
	4.06.980	

N

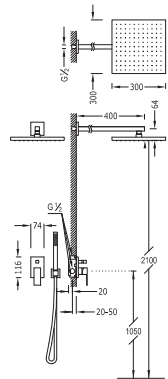

Kit de ducha monomando empotrado

- con cierre y regulación de caudal.
- Cuerpo empotrado incluido
- Ducha fija 300x300 mm. con rótula. Material Latón.
- Soporte con toma pared.
- Ducha móvil anticalcárea.
- Flexo.



91.30.190		
Ac	006.980.02.AC	
NM	006.980.02.NM	
BM	006.980.02.BM	

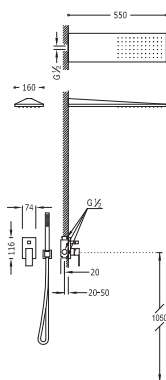

Kit de ducha monomando empotrado
 con cierre y regulación de caudal.
 - Cuerpo empotrado incluido
 - Rociador ducha INOX a pared 160x550 mm.
 - Soporte con toma pared.
 - Ducha móvil anticalcárea.
 - Flexo.



91.30.190 REGRAR
Ac 006.180.03.Ac

91.30.190
NM 006.180.03.NM
BM 006.180.03.BM

BAÑERAS DE REPISA

Monomando bañera de repisa
 con ducha anticalcárea.
 - Caudal: 3 bar - 13 l/m.
 - NOTA: ver longitud caño.

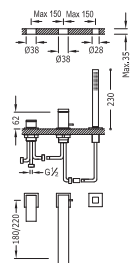

91.30.190 REGRAR (180 mm.)
Ac 006.161.05.Ac

91.30.190 (180 mm.)
NM 006.161.05.NM
BM 006.161.05.BM

91.30.190 REGRAR (220 mm.)
Ac 006.161.03.Ac

91.30.190 (220 mm.)
NM 006.161.03.NM
BM 006.161.03.BM

TERMOSTÁTICAS DE SUPERFICIE

Ducha termostática
 Ducha de mano anticalcárea con soporte orientable y flexo.

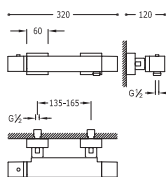

91.06.161.16
 91.06.161.14 REGRAR
6.07.164.9
4.07.164.9

Ducha termostática
 Ducha de mano anticalcárea con soporte orientable y flexo.

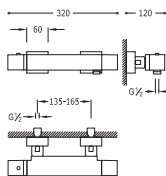

91.06.161.53 REGRAR
Ac 5.07.164.03.9

91.06.161.10.NM
 91.06.161.10.BM
NM 007.164.03.9.NM
BM 007.164.03.9.BM

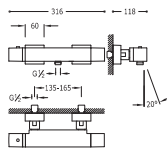

Bañera-ducha termostática

con cascada. Ducha de mano anticalcárea con soporte orientable y flexo.



91.06.161.16	91.06.161.14	
6.07.174.9		
4.07.174.9		

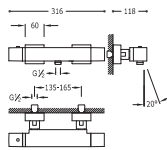

Bañera-ducha termostática

con cascada. Ducha de mano anticalcárea con soporte orientable y flexo.



91.06.161.53	91.06.161.14	
Ac 5.07.14.03.9		
NM 91.06.161.10.NM		
BM 91.06.161.10.BM		
NM 007.174.03.9.NM		N
BM 007.174.03.9.BM		N

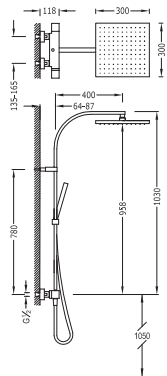

Conjunto ducha termostática

- Ducha fija 300x300 mm. con rótula. Material Latón.
- Ducha móvil anticalcárea.
- Flexo.
- Inversor integrado en el regulador de caudal.



91.06.161.16	91.06.161.14	
6.07.395		
4.07.395		

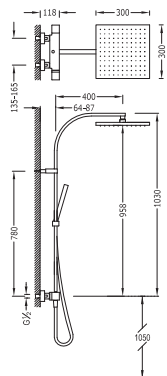

Conjunto ducha termostática

- Ducha fija 300x300 mm. con rótula. Material Latón.
- Ducha móvil anticalcárea.
- Flexo.
- Inversor integrado en el regulador de caudal.



Ac 91.06.161.53		
NM 91.06.161.10.NM		
BM 91.06.161.10.BM		
Ac 007.395.02.AC		
NM 007.395.02.NM		
BM 007.395.02.BM		



Kit de ducha termostático empotrado BLOCK SYSTEM

- con cierre y regulación de caudal (2 vías).
- Cuerpo empotrado termostático incluido
- Rociador ducha INOX a pared 210x550 mm.
- Ducha móvil anticalcárea.
- Flexo.

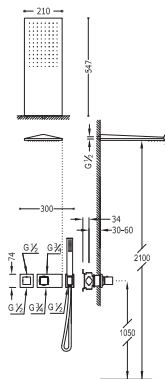

	299.250.45.NE 299.250.45.BL	
	207.252.02.NE	
	207.252.02.BL	



Kit de ducha termostático empotrado BLOCK SYSTEM

- con cierre y regulación de caudal (2 vías).
- Cuerpo empotrado termostático incluido
- Rociador ducha INOX a pared INOX 210x550 mm.
- Ducha móvil anticalcárea.
- Flexo.

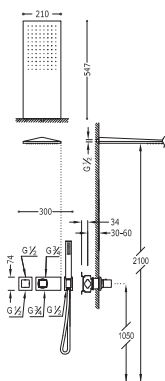

	299.250.45.AC	
	207.252.02.AC	

	NM 299.250.45.NM BM 299.250.45.BM	
	207.252.02.NM	
	207.252.02.BM	





TRES EXCLUSIVE

STUDY EXCLUSIVE

F



- 56 Lavabos
- 62 Bidé
- 63 Monomandos de superficie
- 64 Monomandos empotrados
- 67 Monomando bañera-ducha
- 69 Termostáticas de superficie
- 71 Termostáticas empotradas
- 73 Termostáticas electrónicas empotradas
- 153 Accesorios

RECAMBIOS DE LOS ARTÍCULOS EN:
www.tresgriferia.com

LAVABOS

Ref.:

Monomando lavabo



91.07.190.05

Cr | 261.903.01



91.07.190.05

Cr | 261.903.01.D

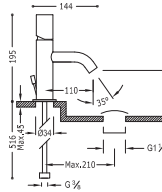

91.07.190.05

- Ac 261.903.01.ACD
- NM 261.903.01.NM.D
- BM 261.903.01.BM.D
- 261.903.01.TAM.D
- 261.903.01.TNA.D
- 261.903.01.TRO.D
- 261.903.01.TVLD
- 261.903.01.TFU.D
- 261.903.01.TVE.D
- 261.903.01.TNE.D
- 261.903.01.TBLD



91.07.190.05

Cr | 261.307.01

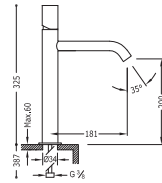

91.07.190.05

- Ac 261.307.01.ACD
- NM 261.307.01.NM.D
- BM 261.307.01.BM.D
- 261.307.01.TAM.D
- 261.307.01.TNA.D
- 261.307.01.TRO.D
- 261.307.01.TVLD
- 261.307.01.TFU.D
- 261.307.01.TVE.D
- 261.307.01.TNE.D
- 261.307.01.TBLD



91.07.190.05

Cr | 261.308.01

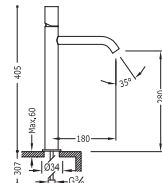

91.07.190.05

- Ac 261.308.01.ACD
- NM 261.308.01.NM.D
- BM 261.308.01.BM.D
- 261.308.01.TAM.D
- 261.308.01.TNA.D
- 261.308.01.TRO.D
- 261.308.01.TVLD
- 261.308.01.TFU.D
- 261.308.01.TVE.D
- 261.308.01.TNE.D
- 261.308.01.TBLD

Monomando lavabo



91.07.190.05

Cr 262.903.01



91.07.190.05

Cr 262.903.01.D

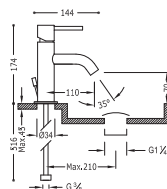

91.07.190.05

- Ac 262.903.01.AC.D
- NM 262.903.01.NM.D
- BM 262.903.01.BM.D
- 262.903.01.TAM.D
- 262.903.01.TNA.D
- 262.903.01.TRO.D
- 262.903.01.TVLD
- 262.903.01.TFU.D
- 262.903.01.TVE.D
- 262.903.01.TNE.D
- 262.903.01.TBLD

N



91.07.190.05

Cr 262.307.01

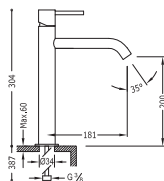

91.07.190.05

- Ac 262.307.01.AC.D
- NM 262.307.01.NM.D
- BM 262.307.01.BM.D
- 262.307.01.TAM.D
- 262.307.01.TNA.D
- 262.307.01.TRO.D
- 262.307.01.TVLD
- 262.307.01.TFU.D
- 262.307.01.TVE.D
- 262.307.01.TNE.D
- 262.307.01.TBLD

N



91.07.190.05

Cr 262.308.01

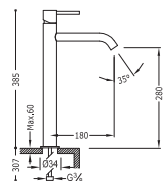

91.07.190.05

- Ac 262.308.01.AC.D
- NM 262.308.01.NM.D
- BM 262.308.01.BM.D
- 262.308.01.TAM.D
- 262.308.01.TNA.D
- 262.308.01.TRO.D
- 262.308.01.TVLD
- 262.308.01.TFU.D
- 262.308.01.TVE.D
- 262.308.01.TNE.D
- 262.308.01.TBLD

N

Monomando lavabo

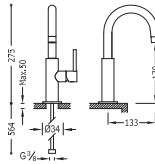

AC	262.904.03.AC.D	
NM	262.904.03.NM.D	N
BM	262.904.03.BM.D	
	262.904.03.TAM.D	
	262.904.03.TNA.D	
	262.904.03.TRO.D	
	262.904.03.TVLD	
	262.904.03.TFUD	
	262.904.03.TVED	
	262.904.03.TNE.D	
	262.904.03.TBLD	

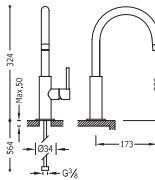

AC	262.904.02.AC.D	
NM	262.904.02.NM.D	N
BM	262.904.02.BM.D	
	262.904.02.TAM.D	
	262.904.02.TNA.D	
	262.904.02.TRO.D	
	262.904.02.TVLD	
	262.904.02.TFUD	
	262.904.02.TVED	
	262.904.02.TNE.D	
	262.904.02.TBLD	

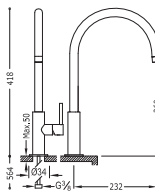

AC	262.904.01.AC.D	
NM	262.904.01.NM.D	N
BM	262.904.01.BM.D	
	262.904.01.TAM.D	
	262.904.01.TNA.D	
	262.904.01.TRO.D	
	262.904.01.TVLD	
	262.904.01.TFUD	
	262.904.01.TVED	
	262.904.01.TNE.D	
	262.904.01.TBLD	



Monomando lavabo de repisa
De instalación libre.

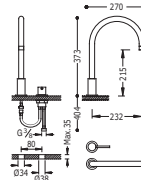

360° 91.30.190
Cr | **261.105.01** |

360° 91.30.190
Ac | **261.105.01.AC** |
Nm | **261.105.01.NM** |
Bm | **261.105.01.BM** |

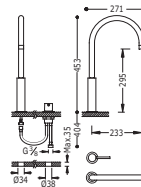

360° 91.30.190
Cr | **261.105.02** |

360° 91.30.190
Ac | **261.105.02.AC** |
Nm | **261.105.02.NM** |
Bm | **261.105.02.BM** |

Bimando de repisa
De instalación libre.

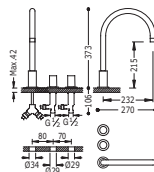

360° 299.105.01
Cr | **061.105.01** |

360° 299.105.01
Ac | **061.105.01.AC** |
Nm | **061.105.01.NM** |
Bm | **061.105.01.BM** |

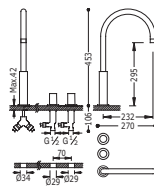

360° 299.105.01
Cr | **061.105.02** |

360° 299.105.01
Ac | **061.105.02.AC** |
Nm | **061.105.02.NM** |
Bm | **061.105.02.BM** |



Monomando lavabo de pie
Cuerpo empotrado para montaje a suelo incluido

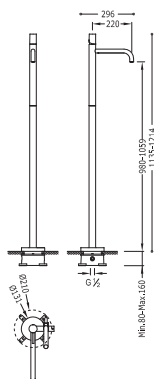
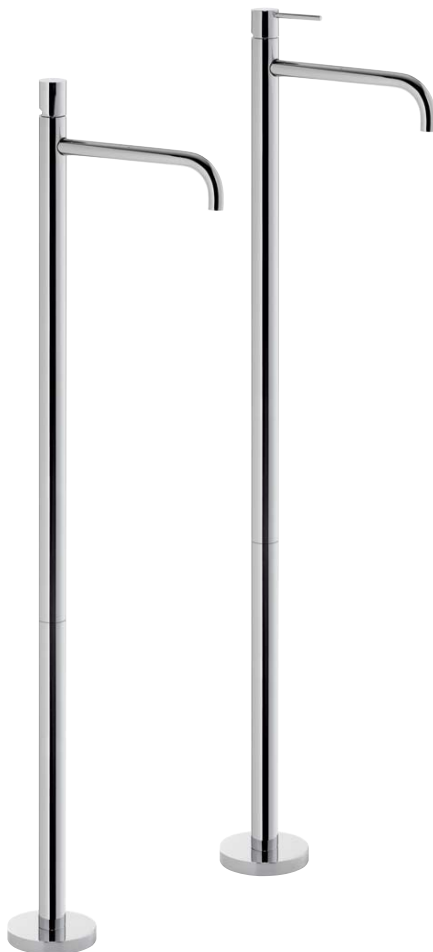

	91.07.190.05	
Cr	262.853.02	
	91.07.190.05	
AC	262.853.02.AC	
NM	262.853.02.NM	
BM	262.853.02.BM	

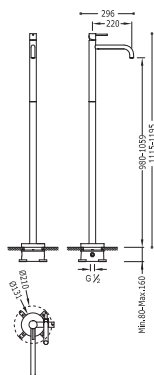

	91.07.190.05	
Cr	262.853.01	
	91.07.190.05	
AC	262.853.01.AC	
NM	262.853.01.NM	
BM	262.853.01.BM	

Monomando mural

Cuerpo empotrado incluido e indivisible. Caño corto 140 mm.

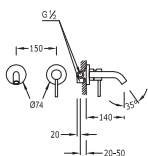

91.30.190
Cr | 262.200.80

Monomando mural

Cuerpo empotrado incluido e indivisible. Caño corto 140 mm.

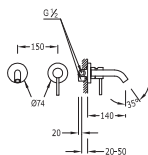

91.30.190

AC	262.200.80.AC	
NM	262.200.80.NM	N
BM	262.200.80.BM	
	262.200.80.TAM	
	262.200.80.TNA	
	262.200.80.TRO	
	262.200.80.TVI	
	262.200.80.TFU	
	262.200.80.TVE	
	262.200.80.TNE	
	262.200.80.TBL	

Monomando mural

Cuerpo empotrado incluido e indivisible. Caño corto 140 mm.

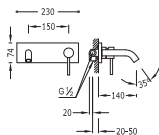

91.30.190
Cr | 262.200.50

Monomando mural

Cuerpo empotrado incluido e indivisible. Caño corto 140 mm.

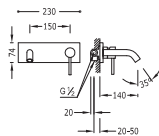

91.30.190

AC	262.200.50.AC	
NM	262.200.50.NM	N
BM	262.200.50.BM	
	262.200.50.TAM	
	262.200.50.TNA	
	262.200.50.TRO	
	262.200.50.TVI	
	262.200.50.TFU	
	262.200.50.TVE	
	262.200.50.TNE	
	262.200.50.TBL	

BIDÉ

Ref.:

Monomando bidé

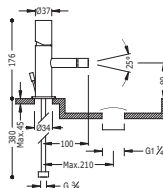

		91.07.190.05
Cr	261.120.01	

		91.07.190.05
Cr	261.120.01.D	

		91.07.190.05
AC	061.120.01.ACD	
NM	061.120.01.NM.D	
BM	061.120.01.BM.D	
	061.120.01.TAM.D	
	061.120.01.TNA.D	
	061.120.01.TRO.D	
	061.120.01.TVL.D	
	061.120.01.TFU.D	
	061.120.01.TVE.D	
	061.120.01.TNE.D	
	061.120.01.TBL.D	

		91.07.190.05
Cr	262.120.01	

		91.07.190.05
Cr	262.120.01.D	

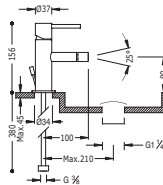

		91.07.190.05
AC	062.120.01.ACD	
NM	062.120.01.NM.D	
BM	062.120.01.BM.D	
	062.120.01.TAM.D	
	062.120.01.TNA.D	
	062.120.01.TRO.D	
	062.120.01.TVL.D	
	062.120.01.TFU.D	
	062.120.01.TVE.D	
	062.120.01.TNE.D	
	062.120.01.TBL.D	

Monomando bidé

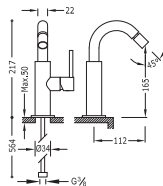

			889-91.30.190
Cr	262.224.02		

			889-91.30.190
AC	262.224.02.ACD		
NM	262.224.02.NM.D		
BM	262.224.02.BM.D		
	262.224.02.TAM.D		
	262.224.02.TNA.D		
	262.224.02.TRO.D		
	262.224.02.TVL.D		
	262.224.02.TFU.D		
	262.224.02.TVE.D		
	262.224.02.TNE.D		
	262.224.02.TBL.D		

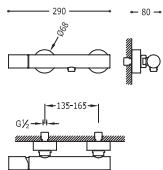

Monomando ducha

Ducha de mano anticalcárea (034.116.01) con soporte orientable y flexo.



Cr | 261.167.01

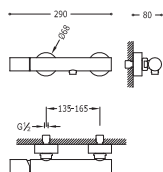

Monomando ducha

Ducha de mano anticalcárea con soporte orientable y flexo.



NM | 261.167.01.NM



AC	261.167.01.AC
BM	261.167.01.BM
	261.167.01.TAM
	261.167.01.TNA
	261.167.01.TRO
	261.167.01.TVI
	261.167.01.TFU
	261.167.01.TVE
	261.167.01.TNE
	261.167.01.TBL

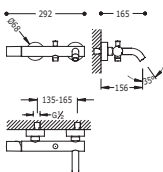

Monomando bañera-ducha

Ducha de mano anticalcárea (034.116.01) con soporte orientable y flexo.



Cr | 261.170.01

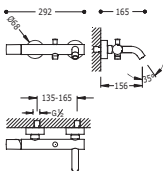

Monomando bañera-ducha

Ducha de mano anticalcárea con soporte orientable y flexo.



NM | 261.170.01.NM



AC	261.170.01.AC
BM	261.170.01.BM
	261.170.01.TAM
	261.170.01.TNA
	261.170.01.TRO
	261.170.01.TVI
	261.170.01.TFU
	261.170.01.TVE
	261.170.01.TNE
	261.170.01.TBL

MONOMANDOS EMPOTRADOS

Ref.:



Monomando empotrar (1 vía)
cuerpo empotrado incluido

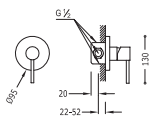

91.30.190 REGADORA
Cr 262.177.90



Monomando empotrar (2 vías)
cuerpo empotrado incluido

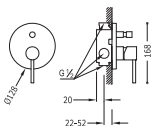

91.30.190 REGADORA
Cr 262.180.90

N



Kit de ducha monomando empotrado

- con cierre y regulación de caudal.
- Cuerpo empotrado incluido
 - Soporte derecha o izquierda, cambiable.
 - Ducha móvil masaje Ø 110 mm. (3 tipos de chorro) (299.749.05).
 - Flexo.

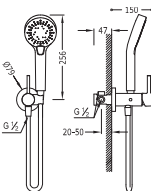

91.34.591
Cr 262.123.01



Kit de ducha monomando empotrado

- con cierre y regulación de caudal.
- Cuerpo empotrado incluido
 - Soporte con toma pared (205.182.01).
 - Ducha móvil anticalcárea (034.116.01).
 - Flexo.

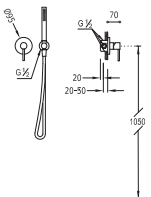

91.30.190 REGADORA
Cr 262.177.92

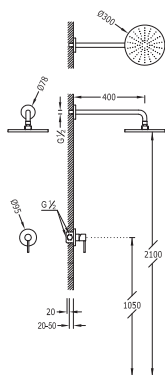

Kit de ducha monomando empotrado

con cierre y regulación de caudal.

- Cuerpo empotrado incluido
- Ducha fija Ø 300 mm. con rótula. Material Latón. (1.34.137.30)



91.30.190 **RECORAZO**
Cr | 262.177.93 |

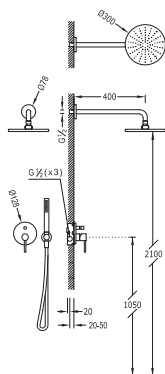

Kit de ducha monomando empotrado

con cierre y regulación de caudal.

- Cuerpo empotrado incluido
- Ducha fija Ø 300 mm. con rótula. Material Latón. (1.34.137.30)
- Soporte con toma pared (205.182.01)
- Ducha móvil anticalcárea (034.116.01)
- Flexo.



91.30.190 **RECORAZO**
Cr | 262.980.91 |

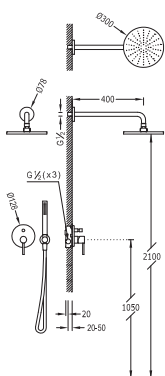

Kit de ducha monomando empotrado

con cierre y regulación de caudal.

- Cuerpo empotrado incluido
- Ducha fija Ø 300 mm. con rótula. Material Latón.
- Soporte con toma pared.
- Ducha móvil anticalcárea.
- Flexo.



91.30.190 **NMI** 262.980.91.NM |



91.30.190 **RECORAZO**

AC	262.980.91.AC
BM	262.980.91.BM
	262.980.91.TAM
	262.980.91.TNA
	262.980.91.TRO
	262.980.91.TVI
	262.980.91.TFU
	262.980.91.TVE
	262.980.91.TNE
	262.980.91.TBL

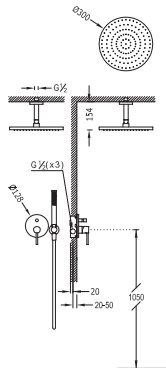

Kit de ducha monomando empotrado

- con cierre y regulación de caudal.
- Cuerpo empotrado incluido
- Ducha fija Ø 300 mm. con rótula. Material Latón. (1.34.137.30).
- Soporte con toma pared (205.182.01).
- Ducha móvil anticalcárea (034.116.01).
- Flexo.



91.30.190
REGARDA
Cr 262.180.80

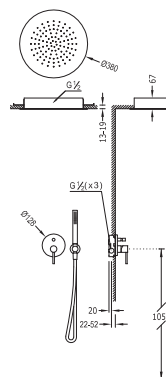

Kit de ducha monomando empotrado

- con cierre y regulación de caudal.
- Cuerpo empotrado incluido
- Rociador ducha INOX a techo Ø 380 mm. (1.34.940).
- Soporte con toma pared (205.182.01).
- Ducha móvil anticalcárea (034.116.01).
- Flexo.



91.30.190
REGARDA
Cr 262.180.99

N

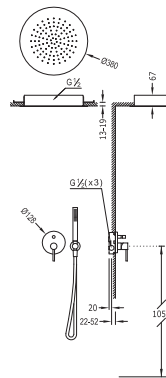

Kit de ducha monomando empotrado

- con cierre y regulación de caudal.
- Cuerpo empotrado incluido
- Rociador ducha INOX a techo Ø 380 mm.
- Soporte con toma pared.
- Ducha móvil anticalcárea.
- Flexo.



91.30.190
AC 262.180.99.AC
NM 262.180.99.NM
BM 262.180.99.BM



Kit de ducha monomando empotrado

- con cierre y regulación de caudal.
- Cuerpo empotrado incluido.
- Caño bañera.
- Soporte con toma pared (205.182.01).
- Ducha móvil anticalcárea (034.116.01).
- Flexo.

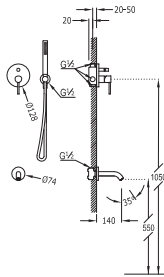

91.30.190
  BIELLAGUARD
 Cr | 262.180.03



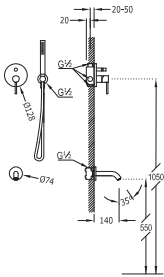

Kit de ducha monomando empotrado

- con cierre y regulación de caudal.
- Cuerpo empotrado incluido.
- Caño bañera.
- Soporte con toma pared.
- Ducha móvil anticalcárea.
- Flexo.



91.30.190
  BIELLAGUARD
 NMI | 262.180.03.NM | N

91.30.190   BIELLAGUARD

Ac	262.180.03.AC
Bm	262.180.03.BM
Tam	262.180.03.TAM
Tna	262.180.03.TNA
Tro	262.180.03.TRO
Tvi	262.180.03.TVI
Tfu	262.180.03.TFU
Tve	262.180.03.TVE
Tne	262.180.03.TNE
Tbl	262.180.03.TBL

MONOMANDO BAÑERA-DUCHA

Monomando bañera de repisa

- con ducha anticalcárea.
- Caudal: 3 bar – 14 l/m.

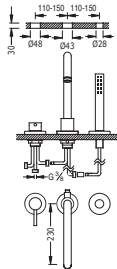

91.34.288
  BIELLAGUARD
 Cr | 261.150.01

91.34.288
  BIELLAGUARD
 Cr | 262.150.01
 Ac | 062.150.01.AC

N Monomando bañera-ducha de pie
 Cuerpo empotrado para montaje a suelo incluido. Ducha de mano anticalcárea (034.116.01) con soporte y flexo.

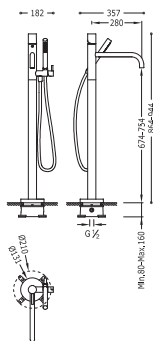

91.07.190.05	91.34.290	
Cr	262.470.02	

91.07.190.05	91.34.290	
AC	262.470.02.AC	
NM	262.470.02.NM	
BM	262.470.02.BM	

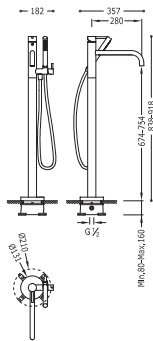

91.07.190.05	91.34.290	
Cr	262.470.01	

91.07.190.05	91.34.290	
AC	262.470.01.AC	
NM	262.470.01.NM	
BM	262.470.01.BM	



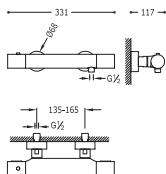

Ducha termostática

Ducha de mano anticalcárea con soporte orientable y flexo.



299.195.03
 Cr | 261.162.09

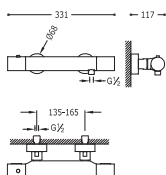

Ducha termostática

Ducha de mano anticalcárea con soporte orientable y flexo.



299.195.03.AC
 Ac | 261.162.09.AC

299.195.03.NM
 299.195.03.BM
 NM | 261.162.09.NM
 BM | 261.162.09.BM

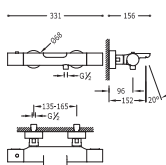

Bañera-ducha termostática

con cascada. Ducha de mano anticalcárea con soporte orientable y flexo.



299.195.03
 Cr | 261.172.09

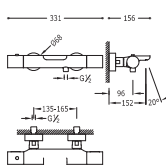

Bañera-ducha termostática

con cascada. Ducha de mano anticalcárea con soporte orientable y flexo.



299.195.03.AC
 Ac | 261.172.09.AC

299.195.03.NM
 299.195.03.BM
 NM | 261.172.09.NM
 BM | 261.172.09.BM

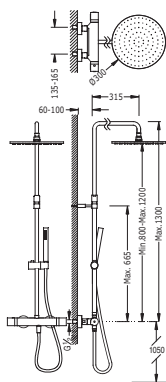

Conjunto ducha termostática

- Ducha fija Ø 300 mm. con rótula. Material Latón (1.34.137.30).
- Ducha móvil anticalcárea (034.116.01).
- Flexo.
- Barra telescópica.
- Inversor integrado en el regulador de caudal.



299.195.03
 Cr | 261.210.01

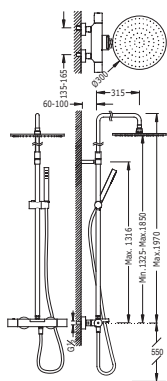

Conjunto bañera-ducha termostática

- Ducha fija Ø 300 mm, con rótula. Material Latón (1.34.137.30).
- Ducha móvil anticalcárea (Ø34.116.01).
- Flexo.
- Barra telescópica.



FUNCIONALIDAD

Cartucho distribuidor con cierre. TRES integra en un solo mando ergonómico un cartucho de regulación de caudal y el inversor distribuidor de salida del agua.





Kit de ducha termostático empotrado BLOCK SYSTEM

- con cierre y regulación de caudal (2 vías).
- Cuerpo empotrado termostático incluido.
- Ducha fija Ø 300 mm. con rótula. Material Latón (1.34.137.30).
- Ducha móvil anticálcarea (034.116.01).
- Flexo SATIN (91.34.609.15).

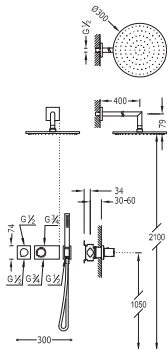

299.195.03
207.352.01



Kit de ducha termostático empotrado BLOCK SYSTEM

- con cierre y regulación de caudal (2 vías).
- Cuerpo empotrado termostático incluido.
- Ducha fija Ø 300 mm. con rótula. Material Latón.
- Ducha móvil anticálcarea.
- Flexo.

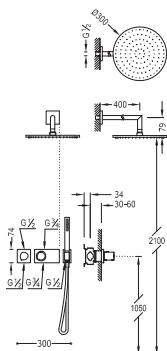

299.195.03.NM
207.352.01.NM

- Ac 299.195.03.AC
- Bm 299.195.03.BM
- Tam 299.195.03.TAM
- Tna 299.195.03.TNA
- Tro 299.195.03.TRO
- Tfu 299.195.03.TFU
- Tve 299.195.03.TVE
- Tne 299.195.03.TNE
- Tbl 299.195.03.TBL

- Ac 207.352.01.AC**
- Bm 207.352.01.BM**
- 207.352.01.TAM**
- 207.352.01.TNA**
- 207.352.01.TRO**
- 207.352.01.TVI**
- 207.352.01.TFU**
- 207.352.01.TVE**
- 207.352.01.TNE**
- 207.352.01.TBL**



Kit de ducha termostático empotrado BLOCK SYSTEM

- con cierre y regulación de caudal (2 vías).
- Cuerpo empotrado termostático incluido.
- Rociador ducha INOX a pared 210x550 mm. (299.903.07).
- Ducha móvil anticalcárea (034.116.01).
- Flexo SATIN (91.34.609.15).

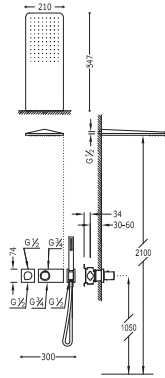

299.195.03

RECORADA

Cr



207.352.02

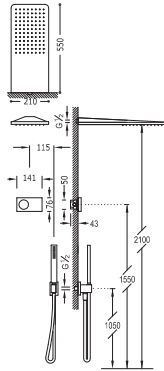

**Kit electrónico de ducha termostático empotrado
SHOWER TECHNOLOGY**

- Control electrónico incluido.
- Centralita termostática electrónica incluida (2 vías).
- Rociador ducha INOX a pared 210x550 mm. (299.903.07).
- Soporte con toma pared (207.182.01).
- Ducha móvil anticálcarea (034.116.01).
- Flexo SATIN (91.34.609.15).



	Cr 092.865.54
	Cr 092.885.54





TRES EXCLUSIVE

LOFT COLORS

- 76 Lavabos
- 81 Bidé
- 82 Monomandos de superficie
- 83 Monomandos empotrados
- 83 Bañeras de repisa
- 84 Termostáticas de superficie
- 86 Termostáticas empotradas
- 153 Accesorios

RECAMBIOS DE LOS ARTÍCULOS EN:
www.tresgriferia.com

LAVABOS

Ref.:

Monomando lavabo



91.30.190

- 200.103.02.AM.D
- 200.103.02.NA.D
- 200.103.02.RO.D
- 200.103.02.VLD
- 200.103.02.F.U.D
- 200.103.02.VED
- 200.103.02.NED
- 200.103.02.BLD

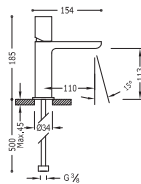

91.30.190

- AC 200.103.02.ACD
- NM 200.103.02.NM.D
- BM 200.103.02.BM.D

91.30.190

- 200.203.04.AM.D
- 200.203.04.NA.D
- 200.203.04.RO.D
- 200.203.04.VLD
- 200.203.04.F.U.D
- 200.203.04.VED
- 200.203.04.NED
- 200.203.04.BLD

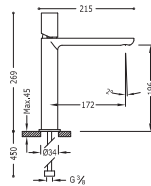

91.30.190

- AC 200.203.04.ACD
- NM 200.203.04.NM.D
- BM 200.203.04.BM.D

91.30.190

- 200.203.06.AM.D
- 200.203.06.NA.D
- 200.203.06.RO.D
- 200.203.06.VLD
- 200.203.06.F.U.D
- 200.203.06.VED
- 200.203.06.NED
- 200.203.06.BLD

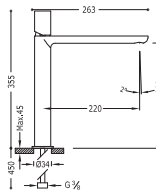

91.30.190

- AC 200.203.06.ACD
- NM 200.203.06.NM.D
- BM 200.203.06.BM.D

Monomando lavabo



91.30.190

- 200.103.01.AM.D
- 200.103.01.NA.D
- 200.103.01.RO.D
- 200.103.01.VLD
- 200.103.01.FU.D
- 200.103.01.VE.D
- 200.103.01.NE.D
- 200.103.01.BLD

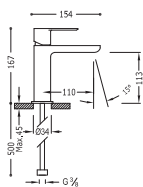

91.30.190

- AC 200.103.01.AC.D
- NM 200.103.01.NM.D
- BM 200.103.01.BM.D

91.30.190

- 200.203.03.AM.D
- 200.203.03.NA.D
- 200.203.03.RO.D
- 200.203.03.VLD
- 200.203.03.FU.D
- 200.203.03.VE.D
- 200.203.03.NE.D
- 200.203.03.BLD

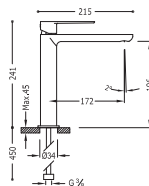

91.30.190

- AC 200.203.03.AC.D
- NM 200.203.03.NM.D
- BM 200.203.03.BM.D

91.30.190

- 200.203.05.AM.D
- 200.203.05.NA.D
- 200.203.05.RO.D
- 200.203.05.VLD
- 200.203.05.FU.D
- 200.203.05.VE.D
- 200.203.05.NE.D
- 200.203.05.BLD

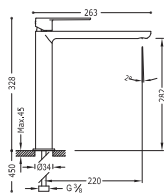

91.30.190

- AC 200.203.05.AC.D
- NM 200.203.05.NM.D
- BM 200.203.05.BM.D

Monomando lavabo

con caño cascada libre. NOTA: La grifería con caño cascada se acompaña con 2 llaves de regulación con filtro (Ref. 91.34.525).

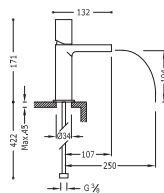

91.30.190	
200.110.02.AM.D	
200.110.02.NA.D	
200.110.02.RO.D	
200.110.02.VI.D	
200.110.02.FU.D	
200.110.02.VE.D	
200.110.02.NE.D	
200.110.02.BLD	

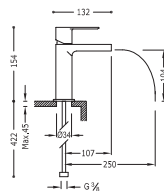

91.30.190	
200.110.01.AM.D	
200.110.01.NA.D	
200.110.01.RO.D	
200.110.01.VI.D	
200.110.01.FU.D	
200.110.01.VE.D	
200.110.01.NE.D	
200.110.01.BLD	

Grifo lavabo 1 agua o premezclada

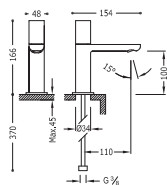

91.34.262		
AC	200.503.01.AC	
NM	200.503.01.NM	N
BM	200.503.01.BM	N

Monomando mural

Cuerpo empotrado incluido e indivisible. Caño de 245 mm.

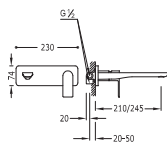

91.34.262	(245 mm.)	
AC	200.200.02.AC	
NM	200.200.02.NM	N
BM	200.200.02.BM	N

Monomando lavabo



360° 91.30.190

- 200.205.04.AM.D
- 200.205.04.NA.D
- 200.205.04.RO.D
- 200.205.04.VL.D
- 200.205.04.FU.D
- 200.205.04.VE.D
- 200.205.04.NE.D
- 200.205.04.BL.D

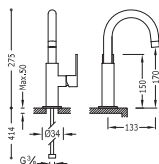

360° 91.30.190

- AC 200.205.04.AC.D
- NM 200.205.04.NM.D
- BM 200.205.04.BM.D



360° 91.30.190

- 200.205.05.AM.D
- 200.205.05.NA.D
- 200.205.05.RO.D
- 200.205.05.VL.D
- 200.205.05.FU.D
- 200.205.05.VE.D
- 200.205.05.NE.D
- 200.205.05.BL.D

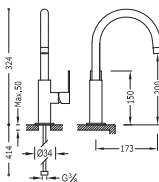

360° 91.30.190

- AC 200.205.05.AC.D
- NM 200.205.05.NM.D
- BM 200.205.05.BM.D



360° 91.30.190

- 200.205.06.AM.D
- 200.205.06.NA.D
- 200.205.06.RO.D
- 200.205.06.VL.D
- 200.205.06.FU.D
- 200.205.06.VE.D
- 200.205.06.NE.D
- 200.205.06.BL.D

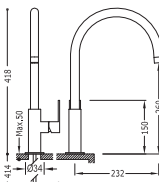

360° 91.30.190

- AC 200.205.06.AC.D
- NM 200.205.06.NM.D
- BM 200.205.06.BM.D



Monomando lavabo
caño de 35x15 mm.



360° 91.30.190

- 200.205.01.AM.D
- 200.205.01.NA.D
- 200.205.01.RO.D
- 200.205.01.VLD
- 200.205.01.FUD
- 200.205.01.VED
- 200.205.01.NED
- 200.205.01.BLD

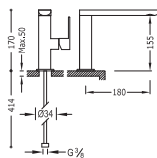

360° 91.30.190

- AC 200.205.01.ACD
- NM 200.205.01.NM.D
- BM 200.205.01.BM.D

360° 91.30.190

- 200.205.02.AM.D
- 200.205.02.NA.D
- 200.205.02.RO.D
- 200.205.02.VLD
- 200.205.02.FUD
- 200.205.02.VED
- 200.205.02.NED
- 200.205.02.BLD

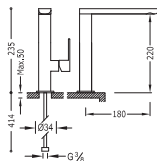

360° 91.30.190

- AC 200.205.02.ACD
- NM 200.205.02.NM.D
- BM 200.205.02.BM.D

360° 91.30.190

- 200.205.03.AM.D
- 200.205.03.NA.D
- 200.205.03.RO.D
- 200.205.03.VLD
- 200.205.03.FUD
- 200.205.03.VED
- 200.205.03.NED
- 200.205.03.BLD

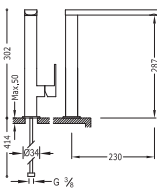

360° 91.30.190

- AC 200.205.03.ACD
- NM 200.205.03.NM.D
- BM 200.205.03.BM.D



Monomando bidé

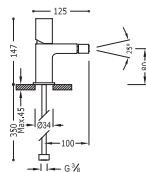

- 91.30.190
- 200.120.02.AM.D
- 200.120.02.NA.D
- 200.120.02.RO.D
- 200.120.02.VI.D
- 200.120.02.FU.D
- 200.120.02.VE.D
- 200.120.02.NE.D
- 200.120.02.BL.D



- 91.30.190
- AC 200.120.02.AC.D
- NM 200.120.02.NM.D
- BM 200.120.02.BM.D

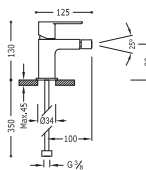

- 91.30.190
- 200.120.01.AM.D
- 200.120.01.NA.D
- 200.120.01.RO.D
- 200.120.01.VI.D
- 200.120.01.FU.D
- 200.120.01.VE.D
- 200.120.01.NE.D
- 200.120.01.BL.D



- 91.30.190
- AC 200.120.01.AC.D
- NM 200.120.01.NM.D
- BM 200.120.01.BM.D

Monomando bidé

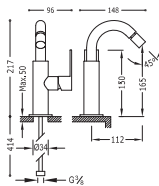

- 360° 91.30.190
- 200.224.01.AM.D
- 200.224.01.NA.D
- 200.224.01.RO.D
- 200.224.01.VI.D
- 200.224.01.FU.D
- 200.224.01.VE.D
- 200.224.01.NE.D
- 200.224.01.BL.D



- 360° 91.30.190
- AC 200.224.01.AC.D
- NM 200.224.01.NM.D
- BM 200.224.01.BM.D

MONOMANDOS DE SUPERFICIE

Ref.:

Monomando ducha

Ducha de mano anticalcárea con soporte orientable y flexo.

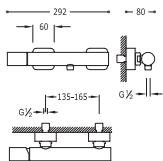

91.30.190	RELOCAR	
	200.167.01.AM	
	200.167.01.NA	
	200.167.01.RO	
	200.167.01.VI	
	200.167.01.FU	
	200.167.01.VE	
	200.167.01.NE	
	200.167.01.BL	

Monomando ducha

Ducha de mano anticalcárea con soporte orientable y flexo.

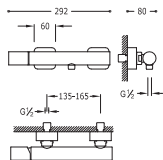

91.30.190	RELOCAR	
AC	200.167.01.AC	
BM	200.167.01.BM	

91.30.190		
NM	200.167.01.NM	

Monomando bañera-ducha

con cascada. Ducha de mano anticalcárea con soporte orientable y flexo.

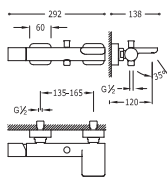

91.30.190	RELOCAR	
	200.170.01.AM	
	200.170.01.NA	
	200.170.01.RO	
	200.170.01.VI	
	200.170.01.FU	
	200.170.01.VE	
	200.170.01.NE	
	200.170.01.BL	

Monomando bañera-ducha

con cascada. Ducha de mano anticalcárea con soporte orientable y flexo.

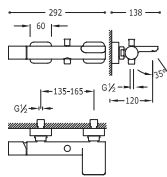

91.30.190	RELOCAR	
AC	200.170.01.AC	
BM	200.170.01.BM	

91.30.190		
NM	200.170.01.NM	

MONOMANDOS EMPOTRADOS

Ref.:

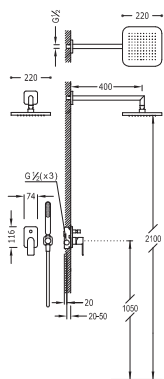

Kit de ducha monomando empotrado

- con cierre y regulación de caudal.
- Cuerpo empotrado incluido
- Ducha fija 220x220 mm. con rótula. (299.632.06).
- Soporte con toma pared.
- Ducha móvil anticalcárea.
- Flexo.



91.30.190	9130190	
200.180.02.AM		
200.180.02.NA		
200.180.02.RO		
200.180.02.VI		
200.180.02.FU		
200.180.02.VE		
200.180.02.NE		
200.180.02.BL		

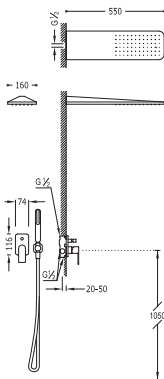

Kit de ducha monomando empotrado

- con cierre y regulación de caudal.
- Cuerpo empotrado incluido
- Rociador ducha INOX a pared 160x550 mm.
- Soporte con toma pared.
- Ducha móvil anticalcárea.
- Flexo.



91.30.190	9130190	
200.180.05.AC		
200.180.05.BM		



91.30.190	9130190	
200.180.05.NM		

BAÑERAS DE REPISA

Monomando bañera de repisa

- con ducha anticalcárea.
- Caudal: 3 bar – 16 l/m.
- NOTA: ver longitud caño.

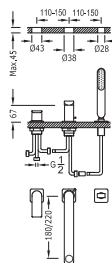

91.34.591	9134591	9134591	(180 mm.)
200.162.03.AC			



91.34.591	9134591	9134591	(180 mm.)
200.162.03.NM			
200.162.03.BM			



91.34.591	9134591	9134591	(220 mm.)
200.162.01.AC			



91.34.591	9134591	9134591	(220 mm.)
200.162.01.NM			
200.162.01.BM			

TERMOSTÁTICAS DE SUPERFICIE

Ref.:

Ducha termostática

Ducha de mano anticalcárea con soporte orientable y flexo.

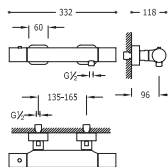

	299.195.03.AM		
	299.195.03.RO		
	299.195.03.FU		
	299.195.03.VI		
	299.195.03.NE		
	299.195.03.BL		
	200.164.09.AM		
	200.164.09.NA		
	200.164.09.RO		
	200.164.09.VI		
	200.164.09.FU		
	200.164.09.VE		
	200.164.09.NE		
	200.164.09.BL		

Ducha termostática

Ducha de mano anticalcárea con soporte orientable y flexo.

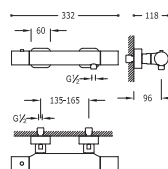

	299.195.03.AC		
	AC 200.164.09.AC		
	299.195.03.NM		
	NM 200.164.09.NM		
	299.195.03.BM		
	BM 200.164.09.BM		

Bañera-ducha termostática

con cascada. Ducha de mano anticalcárea con soporte orientable y flexo.

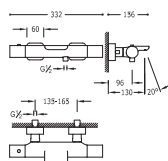

	299.195.03.AM		
	299.195.03.NA		
	299.195.03.RO		
	299.195.03.FU		
	299.195.03.VI		
	299.195.03.NE		
	299.195.03.BL		
	200.174.09.AM		
	200.174.09.NA		
	200.174.09.RO		
	200.174.09.VI		
	200.174.09.FU		
	200.174.09.VE		
	200.174.09.NE		
	200.174.09.BL		

Bañera-ducha termostática

con cascada. Ducha de mano anticalcárea con soporte orientable y flexo.

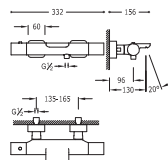

	299.195.03.AC		
	AC 200.174.09.AC		
	NA 299.195.03.NM		
	NM 200.174.09.NM		
	BM 299.195.03.BM		
	BM 200.174.09.BM		

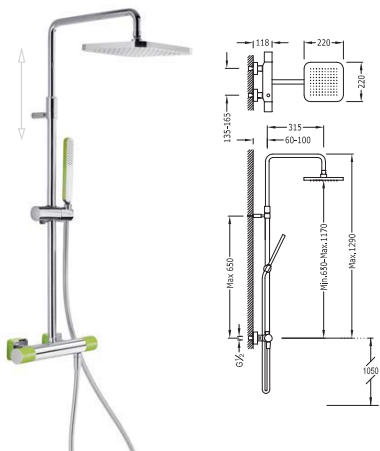

Conjunto ducha termostática

- Ducha fija 220x220 mm. con rótula. (299.632.06).
- Ducha móvil anticalcárea.
- Flexo.
- Barra telescópica.
- Inversor integrado en el regulador de caudal.

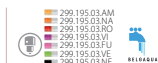

299.195.03.AM	200.195.01.AM
299.195.03.NA	200.195.01.NA
299.195.03.RO	200.195.01.RO
299.195.03.VI	200.195.01.VI
299.195.03.FU	200.195.01.FU
299.195.03.VE	200.195.01.VE
299.195.03.NE	200.195.01.NE
299.195.03.BL	200.195.01.BL





**easy
CLEAN**

**FÁCIL
MANTENIMIENTO**

Con la tecnología EasyCLEAN®, TRES ofrece la posibilidad de limpiar fácilmente el cartucho en caso de obstrucción sin perder su calibración.

TERMOSTÁTICAS EMPOTRADAS

Ref.:



Kit de ducha termostático empotrado BLOCK SYSTEM

- con cierre y regulación de caudal (2 vías).
- Cuerpo empotrado termostático incluido
- Rociador ducha INOX a pared 210x550 mm. (299.903.07)
- Ducha móvil anticalcárea.
- Flexo.

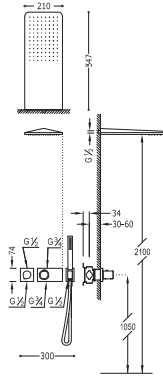

	207.352.02.AM
	207.352.02.NA
	207.352.02.RO
	207.352.02.VI
	207.352.02.FU
	207.352.02.VE
	207.352.02.NE
	207.352.02.BL



Kit de ducha termostático empotrado BLOCK SYSTEM

- con cierre y regulación de caudal (2 vías).
- Cuerpo empotrado termostático incluido
- Rociador ducha INOX a pared 210x550 mm.
- Ducha móvil anticalcárea.
- Flexo.

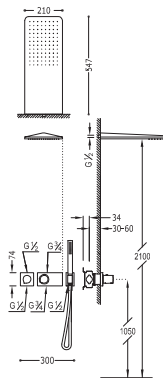

	207.352.02.NM
	207.352.02.AC
	207.352.02.BM







TRES EXCLUSIVE

PROJECT-TRES

- 90 Lavabos
- 98 Bidé
- 98 Monomandos de superficie
- 99 Monomandos empotrados
- 104 Bañeras de repisa
- 105 Termostáticas de superficie
- 107 Termostáticas empotradas
- 153 Accesorios



RECAMBIOS DE LOS ARTÍCULOS EN:
www.tresgriferia.com

N Monomando lavabo



91.30.190

Cr | 211.103.02



91.30.190

Cr | 211.103.02.D

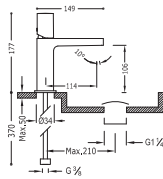

91.30.190

AC | 211.103.02.ACD

NM | 211.103.02.NM.D

BM | 211.103.02.BM.D



91.30.190

Cr | 211.203.02

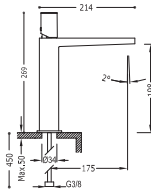

91.30.190

AC | 211.203.02.ACD

NM | 211.203.02.NM.D

BM | 211.203.02.BM.D



91.30.190

Cr | 211.803.02

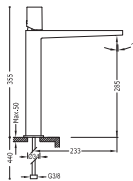

91.30.190

AC | 211.803.02.ACD

NM | 211.803.02.NM.D

BM | 211.803.02.BM.D

N Monomando lavabo



91.30.190
Cr 211.103.01



91.30.190
Cr 211.103.01.D

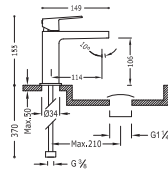

91.30.190
Ac 211.103.01.AC.D
NM 211.103.01.NM.D
BM 211.103.01.BM.D



91.30.190
Cr 211.203.01

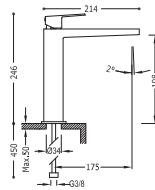

91.30.190
Ac 211.203.01.AC.D
NM 211.203.01.NM.D
BM 211.203.01.BM.D



91.30.190
Cr 211.803.01

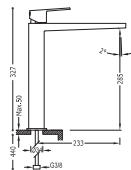

91.30.190
Ac 211.803.01.AC.D
NM 211.803.01.NM.D
BM 211.803.01.BM.D

N Monomando lavabo



360° 91.30.190
Cr | 211.904.01 |

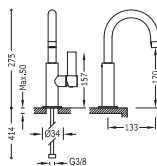

360° 91.30.190
Ac | 211.904.01.AC.D |
NM | 211.904.01.NM.D |
BM | 211.904.01.BM.D |

360° 91.30.190
Cr | 211.905.01 |

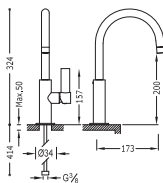

360° 91.30.190
Ac | 211.905.01.AC.D |
NM | 211.905.01.NM.D |
BM | 211.905.01.BM.D |

360° 91.30.190
Cr | 211.906.01 |

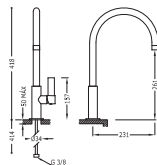

360° 91.30.190
Ac | 211.906.01.AC.D |
NM | 211.906.01.NM.D |
BM | 211.906.01.BM.D |





Monomando lavabo
caño de 34x10 mm.



  
360° 91.30.190
Cr 211.205.01

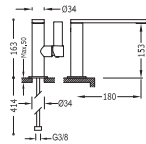

360° 91.30.190
Ac 211.205.01.ACD
NM 211.205.01.NM.D
BM 211.205.01.BM.D

  
360° 91.30.190
Cr 211.305.01

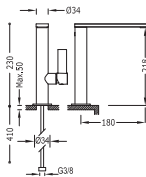

360° 91.30.190
Ac 211.305.01.ACD
NM 211.305.01.NM.D
BM 211.305.01.BM.D

  
360° 91.30.190
Cr 211.405.01

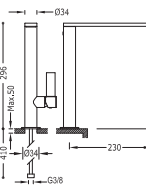

360° 91.30.190
Ac 211.405.01.ACD
NM 211.405.01.NM.D
BM 211.405.01.BM.D



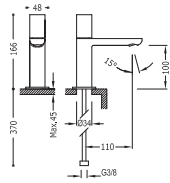

Grifo lavabo 1 agua o premezclada

	91.34.282
Cr	211.503.01



Monomando lavabo de repisa

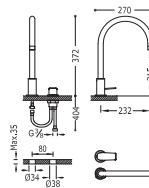

	360° 91.30.190
Cr	211.105.01
AC	211.105.01.AC
NM	211.105.01.NM
BM	211.105.01.BM

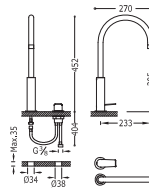

	360° 91.30.190
Cr	211.105.02
AC	211.105.02.AC
NM	211.105.02.NM
BM	211.105.02.BM

Bimando de repisa
De instalación libre.

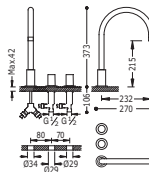

	360° 299.105.01
Cr	061.105.01
AC	061.105.01.AC
NM	061.105.01.NM
BM	061.105.01.BM

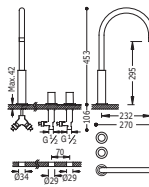

	360° 299.105.01
Cr	061.105.02
AC	061.105.02.AC
NM	061.105.02.NM
BM	061.105.02.BM

N

Monomando mural
Cuerpo empotrado incluido e indivisible.

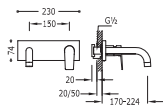

91.30.190 (170 mm.)
Cr | **211.200.01** |

91.30.190 (224 mm.)
Cr | **211.200.02** |

N

Monomando mural
Cuerpo empotrado incluido e indivisible.

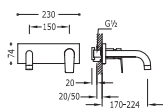

91.30.190 (170 mm.)
Ac | **211.200.01.AC** |
NM | **211.200.01.NM** |
BM | **211.200.01.BM** |

91.30.190 (224 mm.)
Ac | **211.200.02.AC** |
NM | **211.200.02.NM** |
BM | **211.200.02.BM** |

N

Monomando mural
Cuerpo empotrado incluido e indivisible.

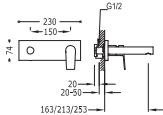

91.30.190 (163 mm.)
Cr | **211.202.01** |

91.30.190 (213 mm.)
Cr | **211.202.02** |

91.30.190 (253 mm.)
Cr | **211.202.03** |

N

Monomando mural
Cuerpo empotrado incluido e indivisible.

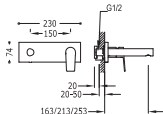

91.30.190 (163 mm.)
Ac | **211.202.01.AC** |
NM | **211.202.01.NM** |
BM | **211.202.01.BM** |

91.30.190 (213 mm.)
Ac | **211.202.02.AC** |
NM | **211.202.02.NM** |
BM | **211.202.02.BM** |

91.30.190 (253 mm.)
Ac | **211.202.03.AC** |
NM | **211.202.03.NM** |
BM | **211.202.03.BM** |

Ref:

N

Monomando mural
Cuerpo empotrado incluido e indivisible.

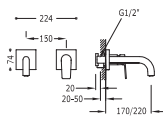

	91.30.190 (170 mm.)
Cr	211.200.80

	91.30.190 (220 mm.)
Cr	211.200.81

N

Monomando mural
Cuerpo empotrado incluido e indivisible.

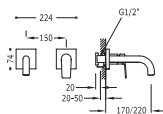

	91.30.190 (170 mm.)
Ac	211.200.80.AC
NM	211.200.80.NM
BM	211.200.80.BM

	91.30.190 (220 mm.)
Ac	211.200.81.AC
NM	211.200.81.NM
BM	211.200.81.BM

N

Monomando mural
Cuerpo empotrado incluido e indivisible.

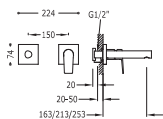

	91.30.190 (163 mm.)
Cr	211.202.81

	91.30.190 (213 mm.)
Cr	211.202.82

	91.30.190 (253 mm.)
Cr	211.202.83

N

Monomando mural
Cuerpo empotrado incluido e indivisible.

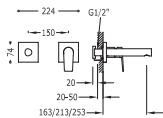

	91.30.190 (163 mm.)
Ac	211.202.81.AC
NM	211.202.81.NM
BM	211.202.81.BM

	91.30.190 (213 mm.)
Ac	211.202.82.AC
NM	211.202.82.NM
BM	211.202.82.BM

	91.30.190 (253 mm.)
Ac	211.202.83.AC
NM	211.202.83.NM
BM	211.202.83.BM

N

Bimando mural

Cuerpo empotrado incluido e indivisible.

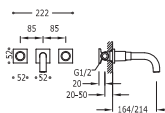

	91.34.282 (164 mm.)
Cr	211.151.01

	91.34.282 (214 mm.)
Cr	211.152.01

N

Bimando mural

Cuerpo empotrado incluido e indivisible.

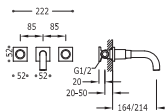

	91.34.282 (164 mm.)
Ac	211.151.01.AC
NM	211.151.01.NM
BM	211.151.01.BM

	91.34.282 (214 mm.)
Ac	211.152.01.AC
NM	211.152.01.NM
BM	211.152.01.BM

N

Bimando mural

Cuerpo empotrado incluido e indivisible.

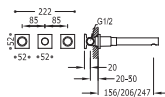

	91.34.282 (156 mm.)
Cr	211.751.01

	91.34.282 (206 mm.)
Cr	211.752.01

	91.34.282 (247 mm.)
Cr	211.753.01

N

Bimando mural

Cuerpo empotrado incluido e indivisible.

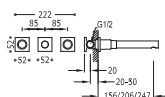

	91.34.282 (156 mm.)
Ac	211.751.01.AC
NM	211.751.01.NM
BM	211.751.01.BM

	91.34.282 (206 mm.)
Ac	211.752.01.AC
NM	211.752.01.NM
BM	211.752.01.BM

	91.34.282 (247 mm.)
Ac	211.753.01.AC
NM	211.753.01.NM
BM	211.753.01.BM

BIDÉ

Ref.:



Monomando bidé

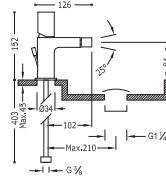

91.30.190
Cr | 211.120.02



91.30.190
Cr | 211.120.02.D



91.30.190
Ac | 211.120.02.ACD

NM | 211.120.02.NM.D

BM | 211.120.02.BM.D

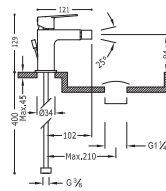

91.30.190
Cr | 211.120.01



91.30.190
Cr | 211.120.01.D



91.30.190
Ac | 211.120.01.ACD

NM | 211.120.01.NM.D

BM | 211.120.01.BM.D



Monomando bidé

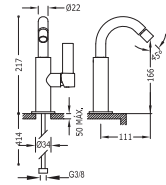

360° 91.30.190
Cr | 211.224.01



360° 91.30.190
Ac | 211.224.01.ACD

NM | 211.224.01.NM.D

BM | 211.224.01.BM.D

MONOMANDOS DE SUPERFICIE



Monomando ducha

Ducha de mano anticalcárea (202.639.01) con soporte orientable y flexo.

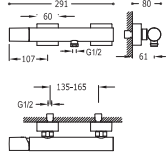

91.30.190
Cr | 211.167.01



Monomando ducha

Ducha de mano anticalcárea con soporte orientable y flexo.

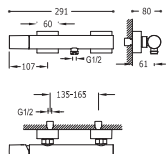

91.30.190
Ac | 211.167.01.AC

NM | 211.167.01.NM

BM | 211.167.01.BM

N

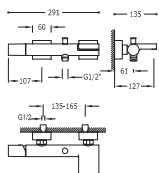

Monomando bañera-ducha
con cascada. Ducha de mano anticalcárea (202.639.01) con soporte orientable y flexo.



91.30.190

Cr | 211.170.01 |

N

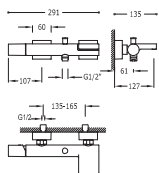

Monomando bañera-ducha
con cascada. Ducha de mano anticalcárea con soporte orientable y flexo.



91.30.190

Ac | 211.170.01.AC |

NM | 211.170.01.NM |

BM | 211.170.01.BM |

MONOMANDOS EMPOTRADOS

N

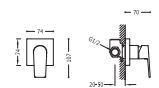

Monomando empotrar (1 vía)
cuerpo empotrado incluido



91.30.190

Cr | 211.177.01 |

N

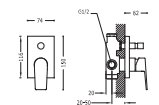

Monomando empotrar (2 vías)
cuerpo empotrado incluido



91.30.190

Cr | 211.180.01 |

N

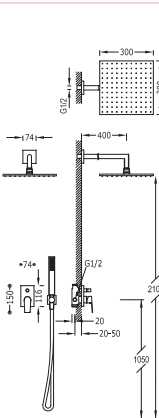

Kit de ducha monomando empotrado

- con cierre y regulación de caudal.
- Cuerpo empotrado incluido
- Ducha fija 300x300 mm. con rótula. (1.34.138.30).
- Soporte con toma pared (061.182.01).
- Ducha móvil anticalcárea (202.639.01).
- Flexo.



91.30.190

Cr | 211.980.91 |

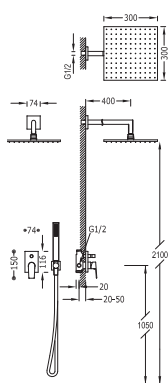

Kit de ducha monomando empotrado

- con cierre y regulación de caudal.
- Cuerpo empotrado incluido
- Ducha fija 300x300 mm. con rótula.
- Soporte con toma pared.
- Ducha móvil anticalcárea.
- Flexo.



91.30.190	
AC	211.980.91.AC
NM	211.980.91.NM
BM	211.980.91.BM

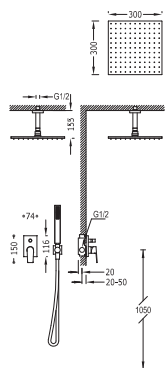

Kit de ducha monomando empotrado

- con cierre y regulación de caudal.
- Cuerpo empotrado incluido
- Ducha fija 300x300 mm. con rótula. (1.34.138.30).
- Soporte con toma pared (061.182.01).
- Ducha móvil anticalcárea (202.639.01).
- Flexo.



91.30.190	
Cr	211.180.80

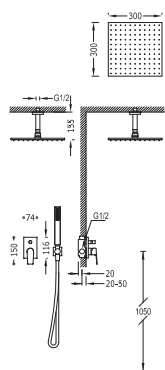

Kit de ducha monomando empotrado

- con cierre y regulación de caudal.
- Cuerpo empotrado incluido
- Ducha fija 300x300 mm. con rótula.
- Soporte con toma pared.
- Ducha móvil anticalcárea.
- Flexo.



91.30.190	
AC	211.180.80.AC
NM	211.180.80.NM
BM	211.180.80.BM

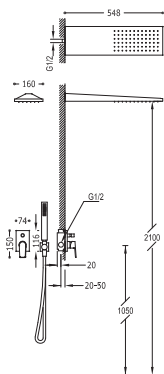

Kit de ducha monomando empotrado

con cierre y regulación de caudal.

- Cuerpo empotrado incluido
- Rociador ducha INOX a pared 160x550 mm. (299.903.03).
- Soporte con toma pared (061.182.01).
- Ducha móvil anticalcárea (202.639.01).
- Flexo.



91.30.190

Cr | 211.980.92

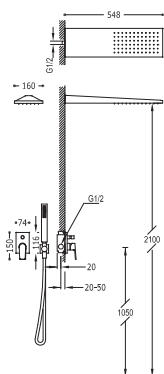

Kit de ducha monomando empotrado

con cierre y regulación de caudal.

- Cuerpo empotrado incluido
- Rociador ducha INOX a pared 160x550 mm.
- Soporte con toma pared.
- Ducha móvil anticalcárea.
- Flexo.



91.30.190

AC | 211.980.92.AC

NM | 211.980.92.NM

BM | 211.980.92.BM

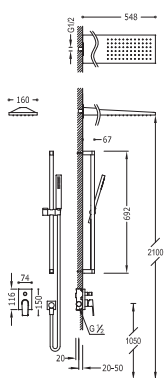

Kit de ducha monomando empotrado

con cierre y regulación de caudal.

- Cuerpo empotrado incluido
- Rociador ducha INOX a pared 160x550 mm. (299.903.03).
- Barra deslizante long. 762 mm. (034.637.08).
- Codo toma pared (061.183.01).
- Ducha móvil anticalcárea (202.639.01).
- Flexo.



91.30.190

Cr | 211.980.93

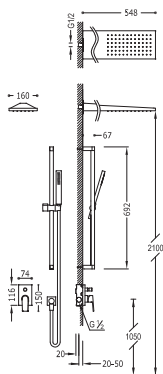

Kit de ducha monomando empotrado

- con cierre y regulación de caudal.
- Cuerpo empotrado incluido
- Rociador ducha INOX a pared 160x550 mm.
- Barra deslizante long. 762 mm.
- Codo toma pared.
- Flexo.



91.30.190

Cr 211.980.93.AC

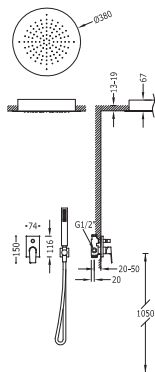

Kit de ducha monomando empotrado

- con cierre y regulación de caudal.
- Cuerpo empotrado incluido
- Rociador ducha INOX a techo Ø 380 mm. (1.34.940).
- Soporte con toma pared (061.182.01).
- Ducha móvil anticalcárea (202.639.01).
- Flexo.



91.30.190

Cr 211.980.99

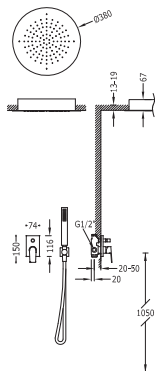

Kit de ducha monomando empotrado

- con cierre y regulación de caudal.
- Cuerpo empotrado incluido
- Rociador ducha INOX a techo Ø 380 mm.
- Soporte con toma pared.
- Ducha móvil anticalcárea.
- Flexo.



91.30.190

Cr 211.980.99.AC

NM 211.980.99.NM

BM 211.980.99.BM

N

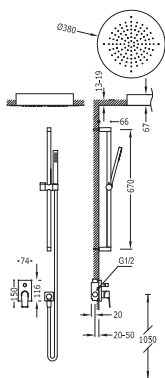

Kit de ducha monomando empotrado

- con cierre y regulación de caudal.
- Cuerpo empotrado incluido
- Rociador ducha INOX a techo Ø 380 mm. (1.34.940).
- Barra deslizante long. 762 mm. (034.637.08).
- Codo toma pared (061.183.01).
- Ducha móvil anticalcárea (202.639.01).
- Flexo.



91.30.190
Cr | 211.980.94

N

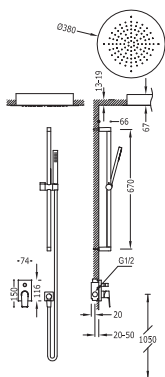

Kit de ducha monomando empotrado

- con cierre y regulación de caudal.
- Cuerpo empotrado incluido
- Rociador ducha INOX a techo Ø 380 mm.
- Barra deslizante long. 762 mm.
- Codo toma pared.
- Ducha móvil anticalcárea.
- Flexo.



91.30.190
AC | 211.980.94.AC

N

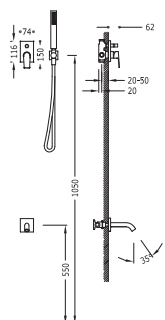

Kit de baño-ducha monomando empotrado

- con cierre y regulación de caudal.
- Cuerpo empotrado incluido
- Caño bañera.
- Soporte con toma pared (061.182.01).
- Ducha móvil anticalcárea (202.639.01).
- Flexo.



91.30.190
Cr | 211.180.03

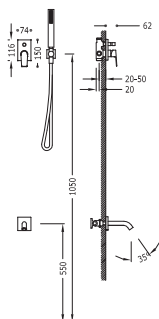

Kit de baño-ducha monomando empotrado

con cierre y regulación de caudal.

- Cuerpo empotrado incluido
- Caño bañera.
- Soporte con toma pared.
- Ducha móvil anticalcárea.
- Flexo.



91.30.190

AC	211.180.03.AC
NM	211.180.03.NM
BM	211.180.03.BM



BAÑERAS DE REPISA

N

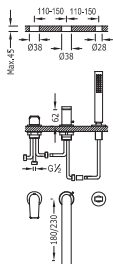

Monomando bañera de repisa

con ducha anticalcárea (202.639.01).

- Caudal: 3 bar – 13 l/m.
- Compatible con el kit depósito ref: 200.245.01.
- NOTA: ver longitud caño.



91.30.190

(230 mm.)

Cr	211.161.03
----	------------



91.30.190

(180 mm.)

Cr	211.161.01
----	------------



N

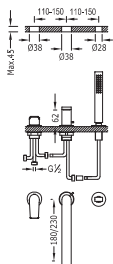

Monomando bañera de repisa

con ducha anticalcárea.

- Caudal: 3 bar – 13 l/m.
- NOTA: ver longitud caño.



91.30.190

(230 mm.)

AC	211.161.03.AC
NM	211.161.03.NM
BM	211.161.03.BM



91.30.190

(180 mm.)

AC	211.161.01.AC
NM	211.161.01.NM
BM	211.161.01.BM



N

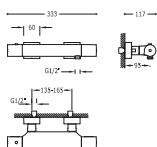

Ducha termostática

Ducha de mano anticalcárea (202.639.01) con soporte orientable y flexo.



299.195.03
Cr | 211.164.09

N

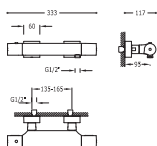

Ducha termostática

Ducha de mano anticalcárea con soporte orientable y flexo.



299.195.03
Ac | 211.164.09.AC
NM | 211.164.09.NM
BM | 211.164.09.BM

N

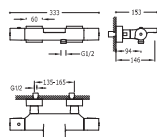

Bañera-ducha termostática

con cascada. Ducha de mano anticalcárea (202.639.01) con soporte orientable y flexo.



299.195.03
Cr | 211.174.09

N

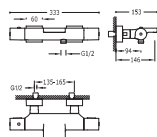

Bañera-ducha termostática

con cascada. Ducha de mano anticalcárea con soporte orientable y flexo.



299.195.03
Ac | 211.174.09.AC
NM | 211.174.09.NM
BM | 211.174.09.BM

N

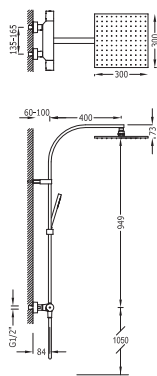

Conjunto ducha termostática

- Ducha fija 300x300 mm. con rótula. (1.34.138.30).
- Ducha móvil anticalcárea (202.639.01).
- Flexo.
- Inversor integrado en el regulador de caudal.



299.195.03
Cr | 211.395.01

N

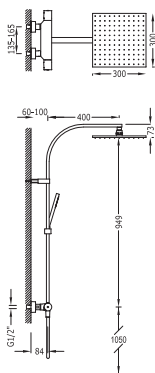

Conjunto ducha termostática

- Ducha fija 300x300 mm. con rótula.
- Ducha móvil anticalcárea.
- Flexo.
- Inversor integrado en el regulador de caudal.



299.195.03

Ac 211.395.01.AC

N

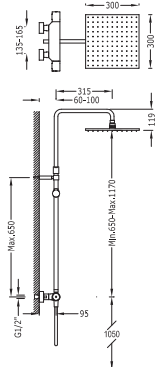

Conjunto ducha termostática

- Ducha fija 300x300 mm. con rótula. (1.34.138.30).
- Ducha móvil anticalcárea (202.639.01).
- Flexo.
- Barra telescópica.
- Inversor integrado en el regulador de caudal.



299.195.03

Cr 211.395.02

N

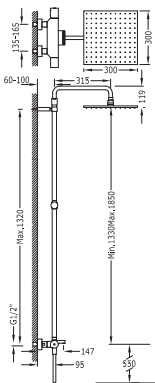

Conjunto bañera-ducha termostática

- Ducha fija 300x300 mm. con rótula. (1.34.138.30).
- Ducha móvil anticalcárea (202.639.01).
- Flexo.
- Barra telescópica.



299.195.03

Cr 211.312.01



Kit de ducha termostático empotrado BLOCK SYSTEM

- con cierre y regulación de caudal (2 vías).
- Cuerpo empotrado termostático incluido.
- Ducha fija Ø 300 mm. con rótula. Material Latón (1.34.137.30).
- Ducha móvil anticalcárea (034.116.01).
- Flexo SATIN (91.34.609.15).

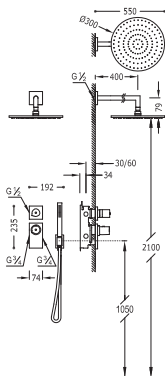

299.195.03 *****
Cr | 206.352.01

N



Kit de ducha termostático empotrado BLOCK SYSTEM

- con cierre y regulación de caudal (2 vías).
- Cuerpo empotrado termostático incluido.
- Ducha fija Ø 300 mm. con rótula. Material Latón.
- Ducha móvil anticalcárea.
- Flexo.

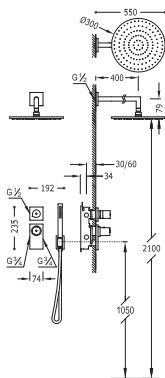

Ac 299.195.03.AC
Nm 299.195.03.NM
Bm 299.195.03.BM

Ac 206.352.01.AC

NM 206.352.01.NM

BM 206.352.01.BM





Kit de ducha termostático empotrado BLOCK SYSTEM

- con cierre y regulación de caudal (2 vías).
- Cuerpo empotrado termostático incluido.
- Rociador ducha INOX a pared 160x550 mm. (299.903.06).
- Ducha móvil anticalcárea (034.116.01).
- Flexo SATIN (91.34.609.15).

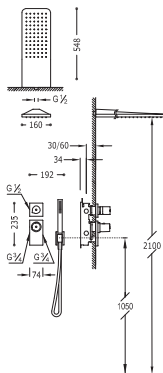

Cr 206.352.02

N



Kit de ducha termostático empotrado BLOCK SYSTEM

- con cierre y regulación de caudal (2 vías).
- Cuerpo empotrado termostático incluido.
- Rociador ducha INOX a pared 160x550 mm.
- Ducha móvil anticalcárea.
- Flexo.

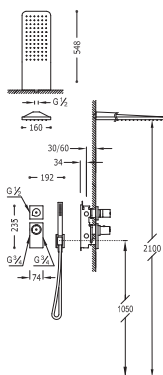

Ac	299.195.03.AC
NM	299.195.03.NM
BM	299.195.03.BM
Ac	206.352.02.AC
NM	206.352.02.NM
BM	206.352.02.BM

Ref: |

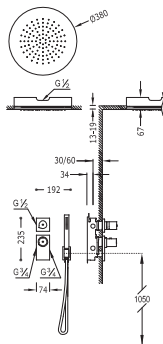

Kit de ducha termostático empotrado BLOCK SYSTEM

- con cierre y regulación de caudal (2 vías).
- Cuerpo empotrado termostático incluido.
- Rociador ducha INOX a techo Ø 380 mm. (1.34.940).
- Ducha móvil anticalcárea (034.116.01).
- Flexo SATIN (91.34.609.15).



Cr | 206.352.04

N

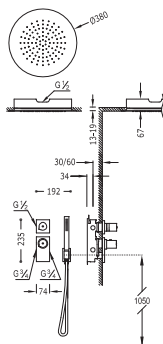

Kit de ducha termostático empotrado BLOCK SYSTEM

- con cierre y regulación de caudal (2 vías).
- Cuerpo empotrado termostático incluido.
- Rociador ducha INOX a techo Ø 380 mm.
- Ducha móvil anticalcárea.
- Flexo.

Ac 299.195.03.AC
Nm 299.195.03.NM
Bm 299.195.03.BM

Ac | 206.352.04.AC

NM | 206.352.04.NM

BM | 206.352.04.BM





CLASIC



MONOCLASIC

113



RETROCLASIC

133



CLASIC

145





TRES EXCLUSIVE

MONOCLASIC

- 114 Lavabos
- 115 Bidé
- 115 Monomandos de superficie
- 116 Elementos de ducha
- 118 Monomandos empotrados
- 123 Bañeras de repisa
- 124 Termostáticas de superficie
- 129 Termostáticas empotradas
- 153 Accesorios

RECAMBIOS DE LOS ARTÍCULOS EN:
www.tresgriferia.com

LAVABOS

Ref.:

N

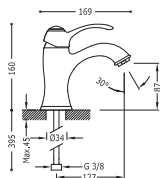

Monomando lavabo



91.34.592
Cr 242.103.01

N

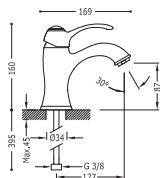

Monomando lavabo



91.34.592
Ac 242.103.01.AC
Lv 242.103.01.LV
Or 242.103.01.OR

N

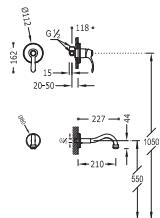

Monomando mural

Cuerpo empotrado incluido e indivisible. Caño de 210 mm.



91.34.592
Cr 242.200.01

N

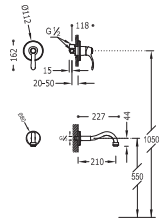

Monomando mural

Cuerpo empotrado incluido e indivisible. Caño de 210 mm.



91.34.592
Ac 242.200.01.AC
Lv 242.200.01.LV
Or 242.200.01.OR

N

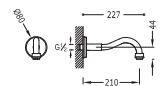

Caño pared



(165 mm.)
Cr 242.173.02



(210 mm.)
Cr 242.173.01

N

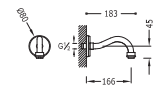

Caño pared



(165 mm.)
Ac 242.173.02.AC
Lv 242.173.02.LV
Or 242.173.02.OR



(210 mm.)
Ac 242.173.01.AC
Lv 242.173.01.LV
Or 242.173.01.OR



BIDÉ

Ref.:

N

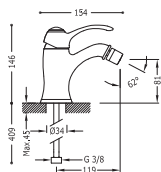

Monomando bidé



91.34.592

Cr | 242.120.01

N

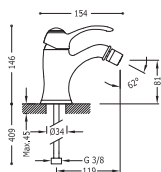

Monomando bidé



91.34.592

Ac | 242.120.01.AC
Lv | 242.120.01.LV
Or | 242.120.01.OR

MONOMANDOS DE SUPERFICIE

N

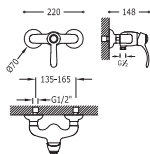

Monomando ducha

Ducha de mano anticálcarea con soporte orientable. Flexo doble engatillado



91.34.592

Cr | 242.167.01

N

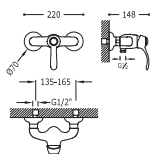

Monomando ducha

Ducha de mano anticálcarea con soporte orientable. Flexo doble engatillado



91.34.592

Ac | 242.167.01.AC
Lv | 242.167.01.LV
Or | 242.167.01.OR

N

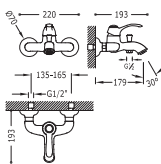

Monomando bañera-ducha

Ducha de mano anticálcarea con soporte orientable. Flexo doble engatillado



91.34.592

Cr | 242.170.01

N

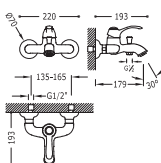

Monomando bañera-ducha

Ducha de mano anticálcarea con soporte orientable. Flexo doble engatillado



91.34.592

Ac | 242.170.01.AC
Lv | 242.170.01.LV
Or | 242.170.01.OR

ELEMENTOS DE DUCHA

Ref.:

N

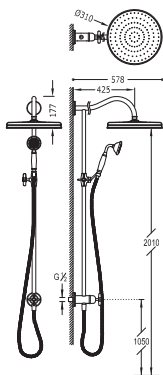

Conjunto ducha anticalcárea

- Ducha fija Ø 310 mm. con rótula. (299.337.03).
- Ducha móvil anticalcárea (299.631.09).
- Flexo doble engatillado.
- Con toma de agua a pared.

Cr 242.476.02

N

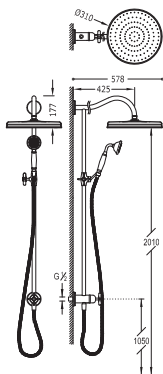

Conjunto ducha anticalcárea

- Ducha fija Ø 310 mm. con rótula.
- Ducha móvil anticalcárea.
- Flexo doble engatillado.
- Con toma de agua a pared.

Ac 242.476.02.AC

Lv 242.476.02.LV

N

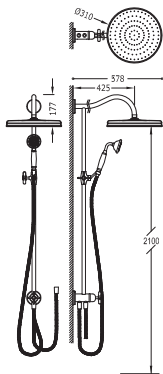

Conjunto ducha anticalcárea

- Ducha fija Ø 310 mm. con rótula. (299.337.03).
- Ducha móvil anticalcárea (299.631.09).
- Flexo doble engatillado.
- Adaptable a grupo de ducha y baño-ducha.

Cr 242.476.01

N

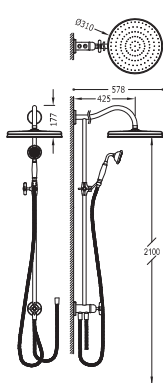

Conjunto ducha anticalcárea

- Ducha fija Ø 310 mm. con rótula.
- Ducha móvil anticalcárea.
- Flexo doble engatillado.
- Adaptable a grupo de ducha y baño-ducha.

Ac | 242.476.01.AC
Lv | 242.476.01.LV

N

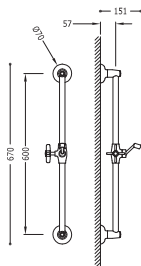

Barra deslizante

Ø 20,6 mm. long. 600 mm.

Cr | 242.732.01

N

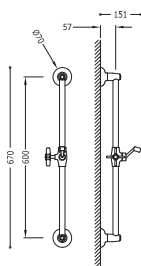

Barra deslizante

Ø 20,6 mm. long. 600 mm.

Ac | 242.732.01.AC
Lv | 242.732.01.LV

N

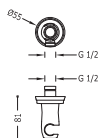

**Soporte para ducha
con toma pared**

Cr | 242.182.01

N

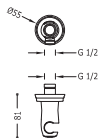

Soporte para ducha con toma pared

Ac	242.182.01.AC
Lv	242.182.01.LV
Or	242.182.01.OR

N

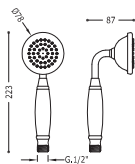

Ducha anticalcárea

Cr	299.631.09
----	------------

N

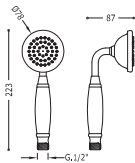

Ducha anticalcárea

Ac	299.631.09.AC
Lv	299.631.09.LV
Or	299.631.09.OR

MONOMANDOS EMPOTRADOS

N

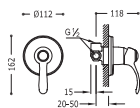

Monomando empotrar (1 vía) cuerpo empotrado incluido

91.34.592	
Cr	242.177.01

N

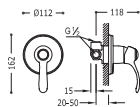

Monomando empotrar (1 vía) cuerpo empotrado incluido

91.34.592	
Ac	242.177.01.AC
Lv	242.177.01.LV
Or	242.177.01.OR

N

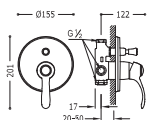

Monomando empotrado (2 vías)
cuerpo empotrado incluido



91.34.592

Cr | 242.180.01

N

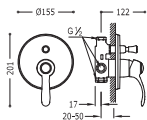

Monomando empotrado (2 vías)
cuerpo empotrado incluido



91.34.592

Ac | 242.180.01.AC

Lv | 242.180.01.LV

Or | 242.180.01.OR

N

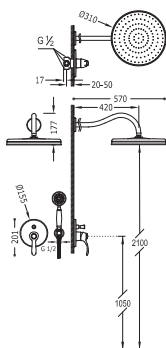

Kit de ducha monomando empotrado

- con cierre y regulación de caudal.
- Cuerpo empotrado incluido
- Ducha fija Ø 310 mm. con rótula. (299.337.03).
- Soporte con toma pared (242.182.01).
- Ducha anticalcárea Ø 78 mm. (299.631.09).
- Flexo doble engatillado.



91.34.592

Cr | 242.180.03

N

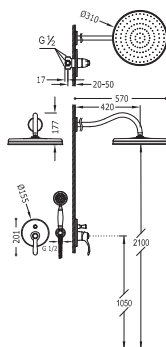

Kit de ducha monomando empotrado

- con cierre y regulación de caudal.
- Cuerpo empotrado incluido
- Ducha fija Ø 310 mm. con rótula.
- Soporte con toma pared.
- Ducha anticalcárea Ø 78 mm.
- Flexo doble engatillado.



91.34.592

Ac | 242.180.03.AC

Lv | 242.180.03.LV

Or | 242.180.03.OR

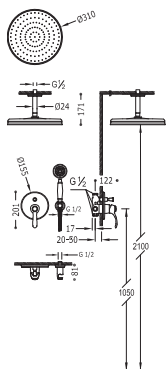

Kit de ducha monomando empotrado

- con cierre y regulación de caudal.
- Cuerpo empotrado incluido
- Ducha fija \varnothing 310 mm. con rótula. (299.337.03).
- Soporte con toma pared (242.182.01).
- Ducha anticalcárea \varnothing 78 mm. (299.631.09).
- Flexo doble engatillado.



Cr 242.180.04

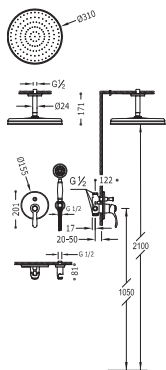

Kit de ducha monomando empotrado

- con cierre y regulación de caudal.
- Cuerpo empotrado incluido
- Ducha fija \varnothing 310 mm. con rótula.
- Soporte con toma pared.
- Ducha anticalcárea \varnothing 78 mm.
- Flexo doble engatillado.



AC 242.180.04.AC
 LV 242.180.04.LV
 Or 242.180.04.OR

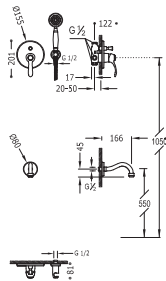

Kit de baño-ducha monomando empotrado

- con cierre y regulación de caudal.
- Cuerpo empotrado incluido
- Caño bañera.
- Soporte con toma pared (242.182.01).
- Ducha anticalcárea \varnothing 78 mm. (299.631.09).
- Flexo doble engatillado.



Cr 242.180.05



Kit de baño-ducha monomando empotrado

con cierre y regulación de caudal.

- Cuerpo empotrado incluido
- Caño bañera.
- Soporte con toma pared.
- Ducha anticalcárea Ø 78 mm.
- Flexo doble engatillado.

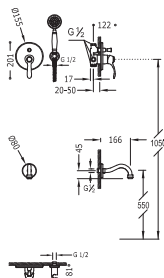

91.34.592

Ac | 242.180.05.AC |

Lv | 242.180.05.LV |

Or | 242.180.05.OR |



Kit de ducha monomando empotrado

con cierre y regulación de caudal.

- Cuerpo empotrado incluido
- Ducha fija Ø 310 mm. con rótula. (299.337.03).
- Ducha anticalcárea Ø 78 mm. (299.631.09).
- Flexo doble engatillado.

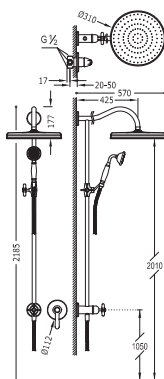

91.34.592

Cr | 242.177.03 |



Kit de ducha monomando empotrado

con cierre y regulación de caudal.

- Cuerpo empotrado incluido
- Ducha fija Ø 310 mm. con rótula.
- Ducha anticalcárea Ø 78 mm.
- Flexo doble engatillado.

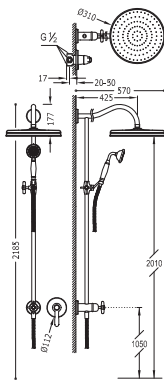

91.34.592

Ac | 242.177.03.AC |

Lv | 242.177.03.LV |

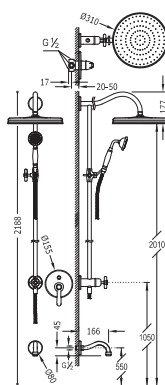

Kit de baño-ducha monomando empotrado (3 vías)

- con cierre y regulación de caudal.
- Cuerpo empotrado incluido
- Ducha fija Ø 310 mm. con rótula. (299.337.03).
- Caño bañera.
- Ducha anticalcárea Ø 78 mm. (299.631.09).
- Flexo doble engatillado.



91.34.592

Cr | 242.180.06

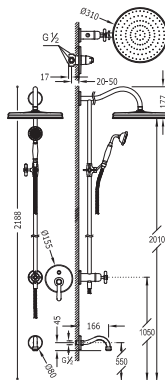

Kit de baño-ducha monomando empotrado (3 vías)

- con cierre y regulación de caudal.
- Cuerpo empotrado incluido
- Ducha fija Ø 310 mm. con rótula.
- Caño bañera.
- Ducha anticalcárea Ø 78 mm.
- Flexo doble engatillado.



91.34.592

Ac | 242.180.06.AC

Lv | 242.180.06.LV

N

Monomando bañera de repisa

con inversor.

- Ducha anticálcea Ø 78 mm. (299.631.09).
- Caudal: 3 bar – 16 l/m.

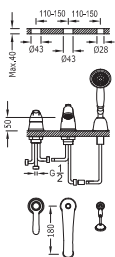

91.34.591

Cr | 242.145.01

N

Monomando bañera de repisa

con inversor.

- Ducha anticálcea Ø 78 mm.
- Caudal: 3 bar – 16 l/m.

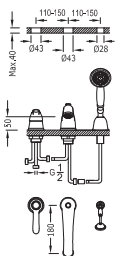

91.34.591

Ac | 242.145.01.AC

Lv | 242.145.01.LV

Or | 242.145.01.OR

N

Monomando bañera-ducha

con tomas de agua a suelo. Ducha de mano anticálcea. Flexo doble engatillado

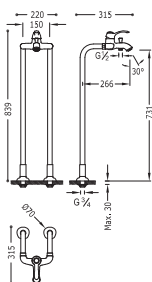

91.34.592

Cr | 242.194.02

N

Monomando bañera-ducha

con tomas de agua a suelo. Ducha de mano anticálcea. Flexo doble engatillado

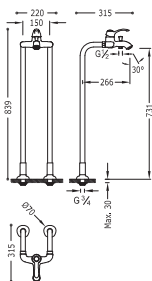

91.34.592

Ac | 242.194.02.AC

Lv | 242.194.02.LV

N

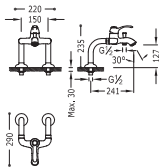

Monomando bañera de repisa
Ducha de mano anticálcarea. Flexo doble engatillado

91.34.592
Cr | **242.194.01**

N

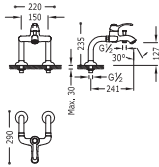

Monomando bañera de repisa
Ducha de mano anticálcarea. Flexo doble engatillado

91.34.592
Ac | **242.194.01.AC**
Lv | **242.194.01.LV**
Or | **242.194.01.OR**

TERMOSTÁTICAS DE SUPERFICIE

N

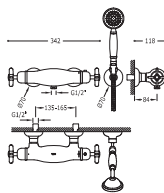

Ducha termostática
Ducha de mano anticálcarea con soporte orientable. Flexo doble engatillado



299.197.01
Cr | **242.164.09**

N

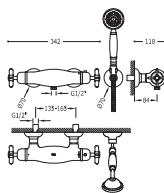

Ducha termostática
Ducha de mano anticálcarea con soporte orientable. Flexo doble engatillado



Ac | 299.197.01.AC
Lv | 299.197.01.LV
Or | 299.197.01.OR
Ac | **242.164.09.AC**
Lv | **242.164.09.LV**
Or | **242.164.09.OR**

N

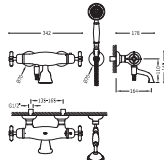

Bañera-ducha termostática
Ducha de mano anticálcarea con soporte orientable. Flexo doble engatillado



299.197.01
Cr | **242.174.09**

N

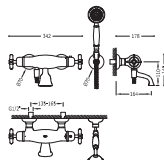

Bañera-ducha termostática
Ducha de mano anticálcarea con soporte orientable. Flexo doble engatillado



Ac | 299.197.01.AC
Lv | 299.197.01.LV
Or | 299.197.01.OR
Ac | **242.174.09.AC**
Lv | **242.174.09.LV**
Or | **242.174.09.OR**

N

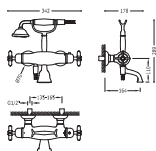

Bañera-ducha termostática con soporte
Ducha de mano anticálcarea y flexo doble engatillado



299.197.01

Cr | 242.176.09

N

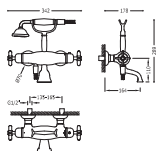

Bañera-ducha termostática con soporte
Ducha de mano anticálcarea y flexo doble engatillado



Ac 299.197.01.AC
Lv 299.197.01.LV
Or 299.197.01.OR

Ac | 242.176.09.AC

Lv | 242.176.09.LV

Or | 242.176.09.OR

N

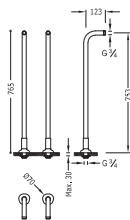

Tomas de agua a suelo de bañera
2 unidades

Cr | 242.194.03

N

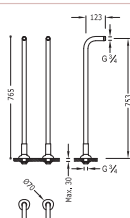
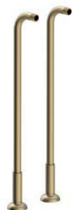

Tomas de agua a suelo de bañera
2 unidades

Ac | 242.194.03.AC

Lv | 242.194.03.LV

N

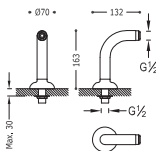

Codo adaptador baño-ducha
2 unidades con silenciador

Cr | 242.871.01

N

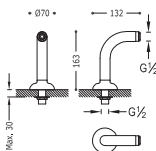

Codo adaptador baño-ducha
2 unidades con silenciador

Ac | 242.871.01.AC

Lv | 242.871.01.LV

Or | 242.871.01.OR

N

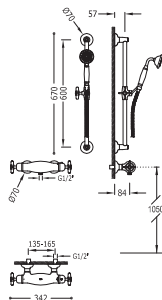

Kit de ducha termostático

- Barra deslizante long. 600 mm.
- Ducha móvil anticalcárea.
- Flexo doble engatillado.



299.197.01

Cr | 242.164.02

N

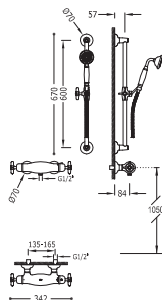

Kit de ducha termostático

- Barra deslizante long. 600 mm.
- Ducha móvil anticalcárea.
- Flexo doble engatillado.



Ac 299.197.01.AC

Lv 299.197.01.LV

Ac | 242.164.02.AC

Lv | 242.164.02.LV

N

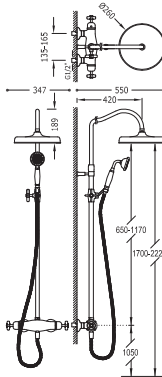

Conjunto ducha termostática

- Ducha fija Ø 310 mm. con rótula. (299.337.03).
- Ducha anticalcárea Ø 78 mm. (299.631.09).
- Flexo doble engatillado.
- Barra telescópica.



299.197.01

Cr | 242.195.02

N

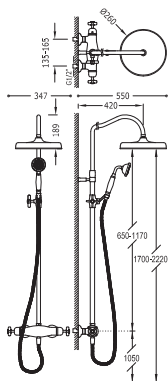

Conjunto ducha termostática

- Ducha fija Ø 310 mm. con rótula.
- Ducha anticalcárea Ø 78 mm.
- Flexo doble engatillado.
- Barra telescópica.



Ac 299.197.01.AC
Lv 299.197.01.LV

Ac | 242.195.02.AC
Lv | 242.195.02.LV

N

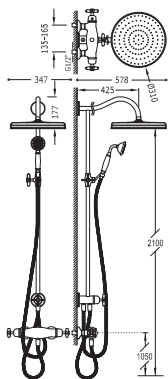

Conjunto ducha termostática

- Ducha fija Ø 310 mm. con rótula. (299.337.03).
- Ducha anticalcárea Ø 78 mm. (299.631.09).
- Flexo doble engatillado.



299.197.01

Cr | 242.195.01

N

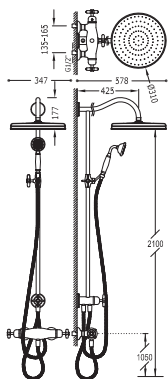

Conjunto ducha termostática

- Ducha fija Ø 310 mm. con rótula.
- Ducha anticalcárea Ø 78 mm.
- Flexo doble engatillado.



Ac 299.197.01.AC
Lv 299.197.01.LV

Ac | 242.195.01.AC
Lv | 242.195.01.LV

N

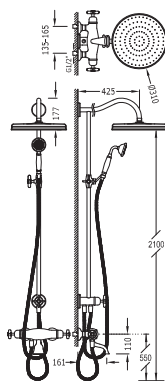

Conjunto bañera-ducha termostática

- Ducha fija Ø 310 mm. con rótula. (299.337.03).
- Ducha anticalcárea Ø 78 mm. (299.631.09).
- Flexo doble engatillado.



299.197.01

Cr | 242.198.01

N

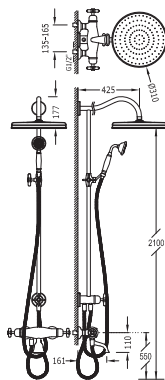

Conjunto bañera-ducha termostática

- Ducha fija Ø 310 mm. con rótula.
- Ducha anticalcárea Ø 78 mm.
- Flexo doble engatillado.



Ac 299.197.01.AC

Lv 299.197.01.LV

Ac | 242.198.01.AC

Lv | 242.198.01.LV

TERMOSTÁTICAS EMPOTRADAS

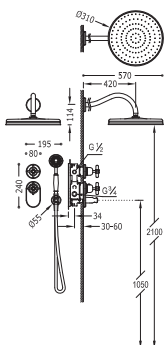

Kit de ducha termostático empotrado

- con cierre y regulación de caudal (2 vías).
- Cuerpo empotrado termostático incluido
- Ducha fija Ø 310 mm. con rótula. (299.337.03).
- Soporte con toma pared (242.182.01).
- Ducha anticálrea Ø 78 mm. (299.631.09).
- Flexo doble engatillado.



Cr | 242.352.02

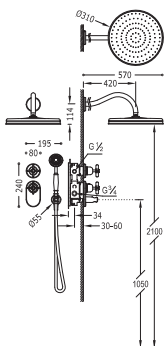

Kit de ducha termostático empotrado

- con cierre y regulación de caudal (2 vías).
- Cuerpo empotrado termostático incluido
- Ducha fija Ø 310 mm. con rótula.
- Soporte con toma pared.
- Ducha anticálrea Ø 78 mm.
- Flexo doble engatillado.



Ac | 242.352.02.AC
Lv | 242.352.02.LV
Or | 242.352.02.OR

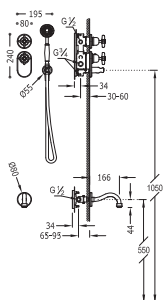

Kit de bañera termostático empotrado

- con cierre y regulación de caudal (2 vías).
- Cuerpo empotrado termostático incluido
- Caño bañera.
- Soporte con toma pared (242.182.01).
- Ducha anticálrea Ø 78 mm. (299.631.09).
- Flexo doble engatillado.



Cr | 242.352.01

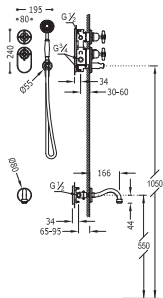

Kit de bañera termostático empotrado

- con cierre y regulación de caudal (2 vías).
- Cuerpo empotrado termostático incluido
- Caño bañera.
- Soporte con toma pared.
- Ducha anticalcárea Ø 78 mm.
- Flexo doble engatillado.



Ac 299.197.01.AC
Lv 299.197.01.LV
Or 299.197.01.OR

Ac	242.352.01.AC
Lv	242.352.01.LV
Or	242.352.01.OR

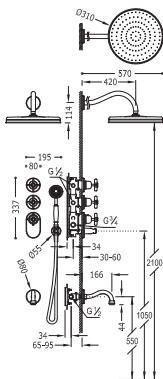

Kit de bañera termostático empotrado

- con cierre y regulación de caudal (2 vías).
- Cuerpo empotrado termostático incluido
- Ducha fija Ø 310 mm. con rótula. (299.337.03).
- Caño bañera.
- Soporte con toma pared (242.182.01).
- Ducha anticalcárea Ø 78 mm. (299.631.09).
- Flexo doble engatillado.



299.197.01

Cr	242.353.01
----	------------

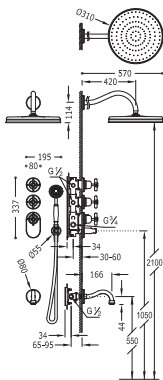

Kit de bañera termostático empotrado

- con cierre y regulación de caudal (2 vías).
- Cuerpo empotrado termostático incluido
- Ducha fija Ø 310 mm. con rótula.
- Caño bañera.
- Soporte con toma pared.
- Ducha anticalcárea Ø 78 mm.
- Flexo doble engatillado.



Ac 299.197.01.AC
Lv 299.197.01.LV
Or 299.197.01.OR

Ac	242.353.01.AC
Lv	242.353.01.LV
Or	242.353.01.OR

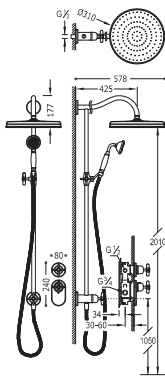

- Kit de ducha termostático empotrado**
 con cierre y regulación de caudal (2 vías).
- Cuerpo empotrado termostático incluido
 - Ducha fija Ø 310 mm. con rótula. (299.337.03).
 - Barra de ducha.
 - Ducha anticalcárea Ø 78 mm. (299.631.09).
 - Flexo doble engatillado.



299.197.01

Cr | 242.352.03 |

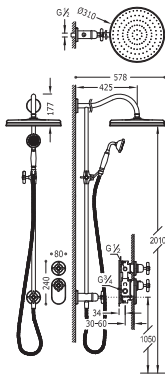

- Kit de ducha termostático empotrado**
 con cierre y regulación de caudal (2 vías).
- Cuerpo empotrado termostático incluido
 - Ducha fija Ø 310 mm. con rótula.
 - Barra de ducha.
 - Ducha anticalcárea Ø 78 mm.
 - Flexo doble engatillado.



Ac 299.197.01.AC
 Cr 299.197.01.LV

Ac | 242.352.03.AC |

LV | 242.352.03.LV |



TRES EXCLUSIVE

RETROCLASIC

- 134 Bimando lavabos
- 136 Bidé
- 136 Bimandos de superficie
- 138 Elementos de ducha
- 139 Monomandos empotrados
- 139 Bañeras de repisa
- 140 Termostáticas de superficie
- 153 Accesorios

RECAMBIOS DE LOS ARTÍCULOS EN:
www.tresgriferia.com

BIMANDO LAVABOS

Ref.:

Bimando lavabo

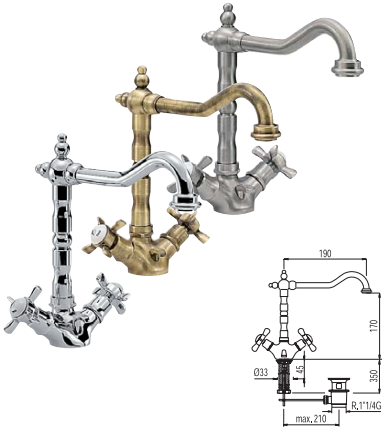

Cr	1.29.104.61		
Lv	5.29.104.01.61		
Ac	5.29.104.03.61		

Monomando lavabo

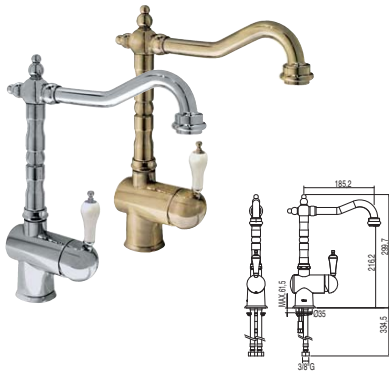

Cr	024.203.01		
Lv	024.203.01.LV		

Bimando lavabo



Cr	1.29.103.61		
Lv	5.29.103.01.61		
Ac	5.29.103.03.61		

Batería lavabo
De instalación libre.

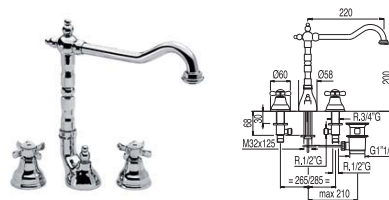

Cr	1.29.105.61		
Lv	5.29.105.01.61		

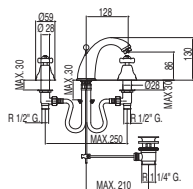

Batería lavabo
De instalación libre.



Cr	1.29.106	
Lv	5.29.106.01	

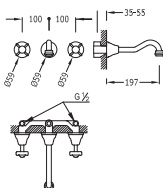

Batería lavabo mural
Cuerpo empotrado incluido e indivisible.

Cr	1.24.151	
Lv	5.24.151.01	

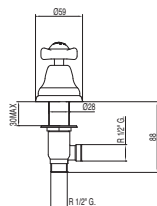

Grifo lateral batería lavabo



Cr	1.24.125.F	
Lv	5.24.125.01.F	



Cr	1.24.125.C	
Lv	5.24.125.01.C	

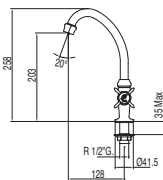

Grifo mando lateral



Cr	1.24.306	
----	----------	--

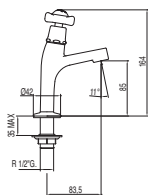

Grifo lavabo 1 agua o premezclada

Cr	1.24.503	
----	----------	--

BIDÉ

Ref.:

Bimando bidé

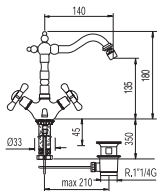

Cr	1.29.124.61	
Lv	5.29.124.01.61	
Ac	5.29.124.03.61	

Monomando bidé

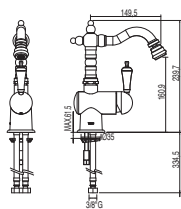

Cr	024.220.01	
Lv	024.220.01.LV	

Bimando bidé

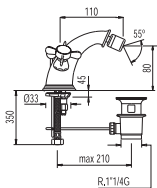

Cr	1.29.120.61	
Lv	5.29.120.01.61	
Ac	5.29.120.03.61	

BIMANDO DE SUPERFICIE

Grupo ducha

Excéntricas con silenciador. Ducha de mano anticalcárea con soporte orientable. Flexo doble engatillado

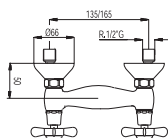

Cr	1.24.167.61	
Lv	5.24.167.01.61	
Ac	5.24.167.03.61	

Grupo baño-ducha

Excéntricas con silenciador. Ducha móvil anticalcárea y flexo doble engatillado.

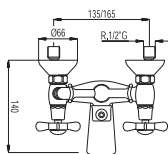

Cr	1.24.170.61	
Lv	5.24.170.01.61	
Ac	5.24.170.03.61	

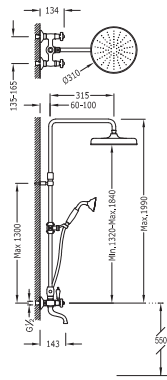

Conjunto bañera-ducha RETRO

- Ducha fija Ø 310 mm. con rótula.
- Ducha móvil anticalcárea.
- Barra telescópica.



Cr | 1.24.290.7

LV | 5.24.290.7.01

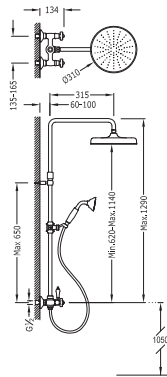

Conjunto ducha RETRO

- Ducha fija Ø 310 mm. con rótula.
- Ducha móvil anticalcárea.
- Barra telescópica.



Cr | 1.24.280.7

LV | 5.24.280.7.01

ELEMENTOS DE DUCHA

Ref:

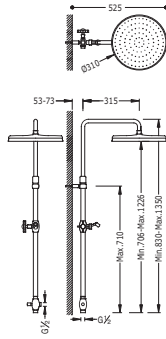

Barra telescópica RETRO
Ducha fija Ø 310 mm. con rótula. Con distribuidor



Cr	024.213.01	
Lv	024.213.01.LV	

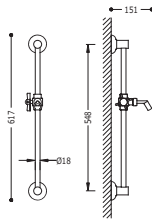

Barra deslizante RETRO

Cr	1.34.732	
Lv	5.34.732.01	

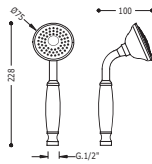

Ducha anticálcarea RETRO

Cr	1.24.824	
Lv	5.24.824.01	

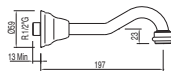

Caño pared RETRO

Cr	1.24.173	
Lv	5.24.173.01	

MONOMANDOS EMPOTRADOS

Monomando empotrar (1 vía)
cuerpo empotrado incluido

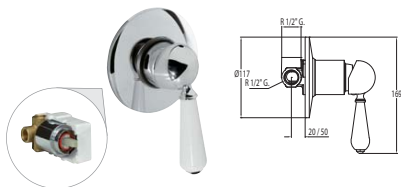

91.34.290 **Cr 024.177.12**

Monomando empotrar (2 vías)
cuerpo empotrado incluido

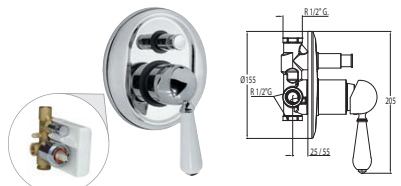

91.34.290 **Cr 024.180.12**

BAÑERAS DE REPISA

Batería bañera de repisa
con inversor.



360° **Cr 1.24.145.61**
LV 5.24.145.01.61

Batería bañera de repisa
con inversor.



Cr 1.24.146
LV 5.24.146.01

TERMOSTÁTICAS DE SUPERFICIE

Ref.:

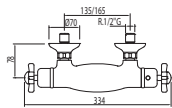

Ducha RETRO termostática

Ducha de mano anticalcárea con soporte orientable. Flexo doble engatillado.



	299.195.11 299.195.11.LV		
Cr	024.164.09		
Lv	024.164.09.LV		

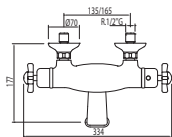

Bañera-ducha RETRO termostática

Ducha de mano anticalcárea con soporte orientable. Flexo doble engatillado.



	299.195.11 299.195.11.LV		
Cr	024.174.09		
Lv	024.174.09.LV		

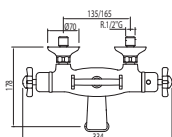

Bañera-ducha RETRO termostática con soporte

Ducha móvil anticalcárea y flexo doble engatillado.



	299.195.11 299.195.11.LV		
Cr	024.176.09		
Lv	024.176.09.LV		

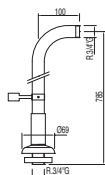

Tomas de agua a suelo de bañera
2 unidades con soporte ducha giratorio

Cr	1.24.194		
Lv	024.194.01.LV		

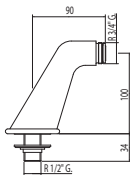

Codo adaptador baño-ducha
2 unidades con silenciador

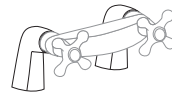

Cr	024.871.01		
Lv	024.871.01.LV		

Conjunto ducha RETRO termostática

- Ducha fija Ø 310 mm. con rótula.
- Ducha móvil anticalcárea.
- Flexo doble engatillado.
- Barra telescópica

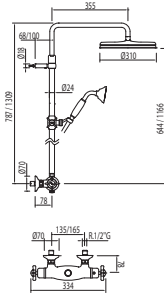

299.195.11
299.195.11.LV

Cr | 024.195.02

LV | 024.195.02.LV



Conjunto ducha RETRO termostática

- Ducha fija Ø 310 mm. con rótula. (299.337.03).
- Ducha móvil anticalcárea (1.24.824).
- Flexo doble engatillado (91.34.828).

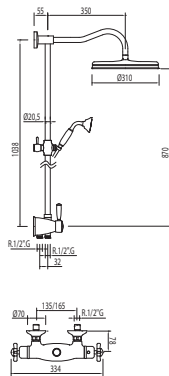

299.195.11
299.195.11.LV

Cr | 024.195.01



Conjunto bañera-ducha RETRO termostática

- Ducha fija Ø 310 mm. con rótula. (299.337.03).
- Ducha móvil anticalcárea (1.24.824).
- Flexo doble engatillado (91.34.828).

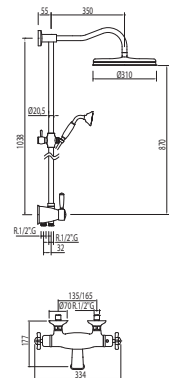

299.195.11
299.195.11.LV

Cr | 024.198.01



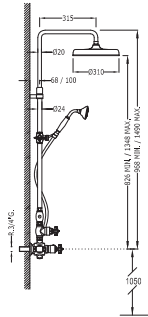

Conjunto ducha RETRO termostática

- Válvulas antirretorno con cierre orientables.
- Soporte ducha regulable.
- Ducha fija Ø 310 mm. con rótula.
- Ducha móvil anticálcea.
- Flexo doble engatillado.
- Barra telescópica



Cr 024.164.04

Lv 024.164.04.LV

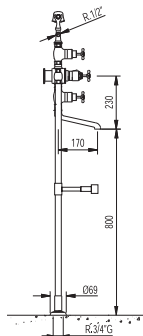

Termostática bañera con columnas de toma de agua al suelo

- Válvulas antirretorno con cierre orientables.
- Flexo doble engatillado.
- Ducha antical.



Cr 1.90.194

Lv 5.90.194.01

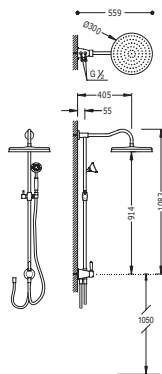

Conjunto ducha anticálcea RETRO

Ducha fija Ø 310 mm. Ducha móvil anticálcea. Adaptable a grupo de ducha y baño-ducha

Cr 024.476.01

VARIOS

Ref.:

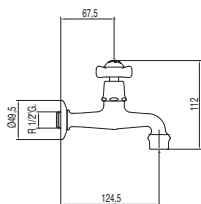

Grifo office

Cr | 1.24.520

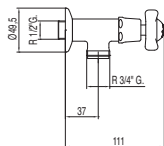

Grifo lavadora
salida rosca de 3/4"

Cr | 1.24.500

LLAVES DE PASO

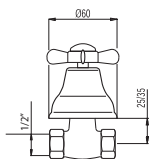

Llave de paso
1/2"

F

Cr | 1.24.155.61.F

LV | 5.24.155.01.61.F

C

Cr | 1.24.155.61.C

LV | 5.24.155.01.61.C

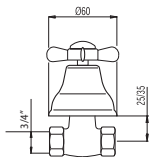

Llave de paso
3/4"

F

Cr | 1.24.157.61.F

LV | 5.24.157.01.61.F

C

Cr | 1.24.157.61.C

LV | 5.24.157.01.61.C



TRES EXCLUSIVE

CLASIC

- 146 Bimando lavabos
- 147 Bidé
- 147 Bimandos de superficie
- 148 Elementos de ducha
- 149 Bañeras de repisa
- 149 Termostáticas de superficie
- 153 Accesorios



RECAMBIOS DE LOS ARTÍCULOS EN:
www.tresgriferia.com

BIMANDO LAVABOS

Ref.:

Bimando lavabo

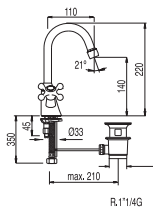

Cr 1.32.104
Lv 5.32.104.01



Cr 1.37.104
Lv 5.37.104.01

Grifo lavabo de 1/2"

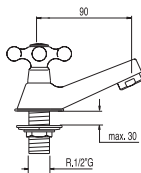

Cr 1.32.100.F



Cr 1.32.100.C

Bimando lavabo

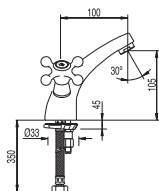

Cr 1.32.103



Cr 1.37.103

Batería lavabo

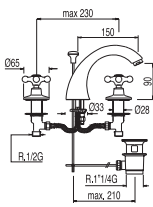

Cr 1.37.106
Lv 5.37.106.01

Grifo lateral

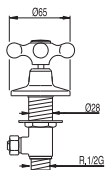

Cr 1.32.510.F



Cr 1.32.510.C

BIDÉ

Ref.:

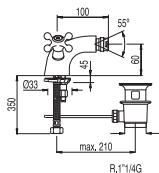

Bimando bidé



Cr 1.32.120



Cr 1.37.120

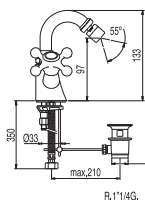

Bimando bidé



Cr 1.32.124

LV 5.32.124.01



Cr 1.37.124

LV 5.37.124.01

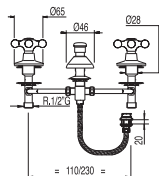

Batería bidé con duchita

Cr 1.32.130

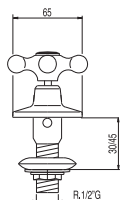

Grifo bidé de 1/2"



Cr 1.32.125.F

LV 5.32.125.01.F



Cr 1.32.125.C

LV 5.32.125.01.C

BIMANDO DE SUPERFICIE

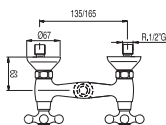

Grupo ducha

Ducha de mano anticalcárea con soporte orientable. Flexo doble engatillado

Cr 1.32.768

LV 5.32.765.01

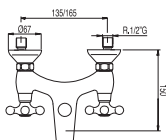

Grupo baño-ducha

Ducha de mano anticalcárea con soporte orientable. Flexo doble engatillado

Cr 1.32.774

LV 5.32.771.01

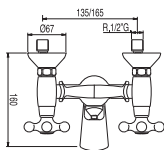

Grupo baño-ducha

Ducha anticalcárea. Flexo doble engatillado

Cr 1.32.176

Lv 5.32.176.01

ELEMENTOS DE DUCHA

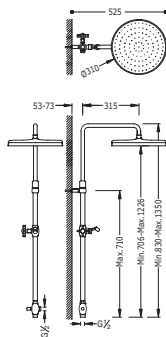

Barra telescópica CLASIC

Ducha fija Ø 310 mm. con rótula. Con distribuidor

Cr 024.213.01

Lv 024.213.01.LV

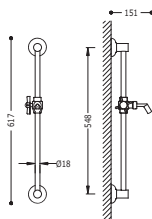

Barra deslizante RETRO

Cr 1.34.732

Lv 5.34.732.01

Ac 5.34.732.03

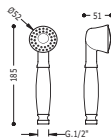

Ducha anticalcárea

Cr 91.34.824

Lv 91.34.824.05.1

Ac 91.34.824.05.3

BAÑERAS DE REPISA

Ref.: |

Batería bañera de repisa

con inversor.
- Caudal: 3 bar – 12 l/m.

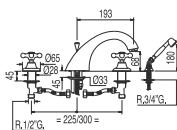

Cr	1.32.145
LV	5.32.145.01

TERMOSTÁTICAS DE SUPERFICIE

Ducha CLASIC termostática

Ducha de mano anticárca con soporte orientable. Flexo doble engatillado

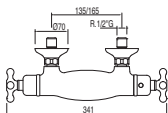

Cr	032.164.09
LV	032.164.09.LV

Bañera- ducha CLASIC termostática

Ducha de mano anticárca con soporte orientable. Flexo doble engatillado

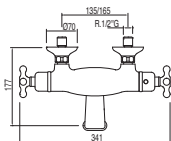

Cr	032.174.09
LV	032.174.09.LV

Bañera- ducha CLASIC termostática con soporte

Ducha móvil anticárca y flexo doble engatillado

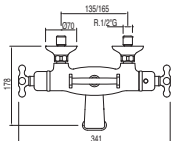

Cr	032.176.09
LV	032.176.09.LV

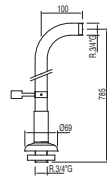

Tomas de agua a suelo de bañera
2 unidades con soporte ducha giratorio

Cr 1.24.194

Lv 024.194.01.LV

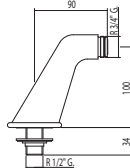

Codo adaptador baño-ducha
2 unidades con silenciador

Cr 024.871.01

Lv 024.871.01.LV

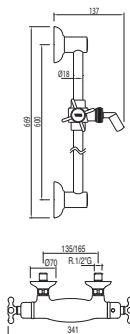
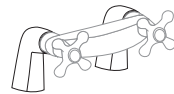

Kit de ducha termostático CLASIC
- Barra deslizante RETRO long. 550 mm.
- Ducha móvil anticalcárea.
- Flexo doble engatillado.

299.195.10
299.195.10.LV



Cr 032.164.02

Lv 032.164.02.LV

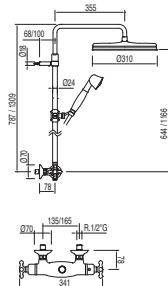

Conjunto ducha CLASIC termostática

- Ducha fija Ø 310 mm. con rótula.
- Ducha móvil anticalcárea.
- Flexo doble engatillado.
- Barra telescópica.

299.195.10
299.195.10.LV



Cr 032.195.02

Lv 032.195.02.LV



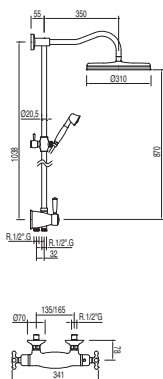

Conjunto ducha CLASIC termostática

- Ducha fija Ø 310 mm. con rótula. (299.337.03).
- Ducha móvil anticalcárea (91.34.824).
- Flexo doble engatillado (91.34.828).

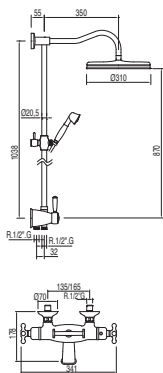

Conjunto bañera-ducha CLASIC termostática

- Ducha fija Ø 310 mm. con rótula. (299.337.03).
- Ducha móvil anticalcárea (91.34.824).
- Flexo doble engatillado (91.34.828).



LAVES DE PASO

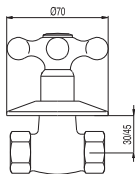

Llave de paso rosca de 1/2"

F	Cr	1.33.155.F
	LV	5.33.155.01.F

C	Cr	1.33.155.C
	LV	5.33.155.01.C

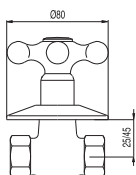

Llave de paso rosca de 3/4"

F	Cr	1.33.157.F
	LV	5.33.157.01.F

C	Cr	1.33.157.C
	LV	5.33.157.01.C



TRES EXCLUSIVE

ACCESORIOS

- 156 Slim-Tres
- 157 Cuadro-Tres
- 158 Max-Tres / Class-Tres
- 160 Loft-Tres
- 162 Clasic





































DECORACIÓN PARA BAÑOS SINGULARES

Las diferentes líneas de accesorios comparten el minimalismo estético, ofreciendo adaptabilidad en cualquier espacio y facilidad en su limpieza.

Los accesorios combinan el **cromado de alta resistencia** con la **cerámica blanca**, dando sencillez y robustez al producto. Están fabricados con materiales de calidad **resistentes al desgaste**.



	slim-tres	cuadro-tres	max-tres class-tres	loft-tres	clasic
	Líneas rectas y cúbicas, puede combinar con accesorios Slim-tres.	Diseño recto con superficies planas y sobrias. Combinable con accesorios Cuadro-tres.	Estética redonda o tubular fácilmente adaptable a cualquier espacio.	Superficies planas con cantos curvos, estilo moderno y singular.	El accesorio perfecto para baños rústicos o de aspecto antiguo.
					
					
					
					
					
					
					



SLIM-TRES

Ref.:

Toallero

Toallero



(450 mm.)

Cr | 202.636.04 |



(600 mm.)

Cr | 202.636.05 |

Portarrollos sin tapa

Escobillero de suelo cerámico



Cr | 202.636.12 |

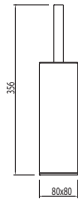

Cr | 202.636.11 |

Dosificador jabón de encimera cerámico

Jabonera de encimera cerámica

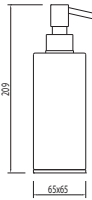

Cr | 202.636.08 |

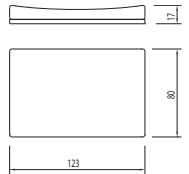

Cr | 202.636.07 |

Vaso de sobremesa cerámico

Percha

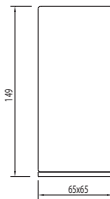

Cr | 202.636.09 |

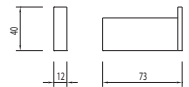

Cr | 202.636.13 |

CUADRO-TRES

Ref.:

Toallero

Percha

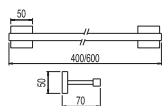

(400 mm.)
Cr | 1.07.636.01 |
(600 mm.)
Cr | 1.07.636.03 |

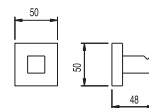

Cr | 1.07.636.20 |

Repisa toallas

Escobillero de suelo cerámico



Cr | 1.07.636.08 |



Cr | 1.07.636.23 |

Portarrollos sin tapa

Cubo papelera pedal
180x180x250 mm

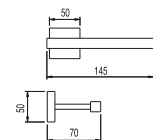

Cr | 1.07.636.06 |

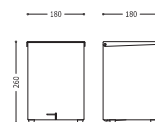

Inox | 1.07.636.27 |

Escobilla

Escobilla

(para ref.: 187.636.23, 1.87.636.24, 1.61.636.50.23, 1.61.636.50.23, 1.61.636.60.23, 1.61.636.50.24, 1.61.636.60.24, 1.61.636.23, 1.61.636.23.53, 1.61.636.24, 5.61.636.24.53, 1.24.636.04, 5.24.636.04.51, 1.07.636.23)

(para ref.: 200.636.10, 202.636.11, 200.636.11)

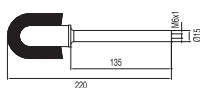

Bl | 91.87.636.90 |

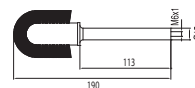

Bl | 91.200.636.90 |

MAX-TRES / CLASS-TRES

Ref.:

Toallero

Portarrollos sin tapa



	(480 mm.)
Cr	1.61.636.01
	(580 mm.)
Cr	1.61.636.02

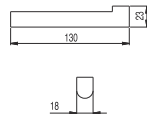

Cr	1.14.636.09
----	-------------

Toallero

Escobillero de suelo cerámico

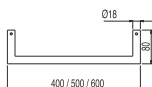

	(400 mm.)
Cr	1.14.636.01
	(500 mm.)
Cr	1.14.636.03
	(600 mm.)
Cr	1.14.636.02

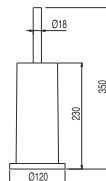

Cr	1.61.636.23
----	-------------

Toallero barra doble

Escobillero de pared cerámico

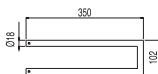

Cr	1.14.636.10
----	-------------

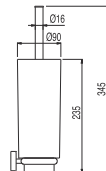

Cr	1.61.636.24
----	-------------

Portarrollos sin tapa

Escobillero de pared

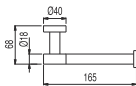

Cr	1.61.636.06
----	-------------

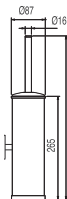

Cr	1.34.636.24
----	-------------

Ref.: |

Dosificador jabón de pared cerámico

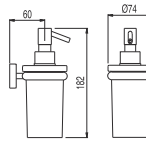

Cr | 1.61.636.18

Portacepillos de pared cerámico

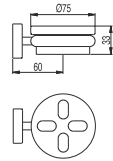

Cr | 1.61.636.16
Ac | 5.61.636.16.53

Asidero bañera

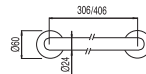

(306 mm.)
Cr | 1.34.184
(406 mm.)
Cr | 1.34.184.40

Percha

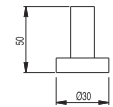

Cr | 1.61.636.20

Asidero angular

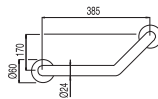

Cr | 1.34.183

LOFT-TRES

Ref.:

Toallero

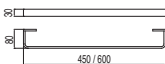

(450 mm.)

Cr | 200.636.04 |

(600 mm.)

Cr | 200.636.05 |

Repisa cristal transparente

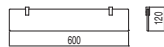

(600 mm.)

Cr | 200.636.06 |

Portarrollos sin tapa

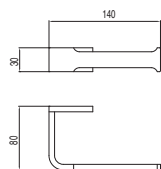

Cr | 200.636.12 |

Repisa cristal transparente

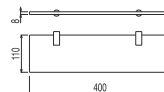

(400 mm.)

Cr | 1.61.636.15 |

Escobillero de suelo cerámico

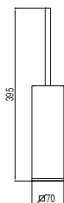

Cr | 200.636.11 |

Dosificador jabón de encimera cerámico

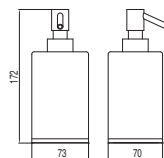

Cr | 200.636.08 |

Escobillero de pared cerámico

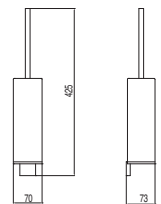

Cr | 200.636.10 |

Jabonera de encimera cerámica

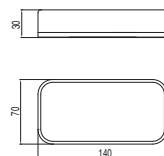

Cr | 200.636.07 |

Vaso de sobremesa cerámico

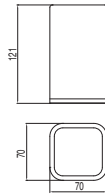

Cr | 200.636.09 |

Percha

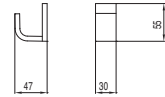

Cr | 200.636.13 |



CLASIC

Ref.:

Toallero

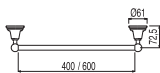

	(400 mm.)
Cr	1.24.636.01
LV	5.24.636.01.51
	(600 mm.)
Cr	1.24.636.03
LV	5.24.636.03.51

Portarrollos con tapa

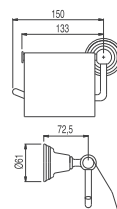

Cr	1.24.636.05
LV	5.24.636.05.51

Toallero barra doble

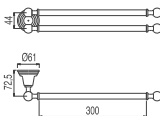

Cr	1.24.636.08
LV	5.24.636.08.51

Toallero anilla abierto izquierda con jabonera

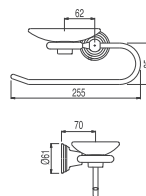

Cr	1.24.636.11
LV	5.24.636.11.51

Toallero anilla cuadrado

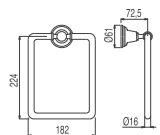

Cr	1.24.636.09
LV	5.24.636.09.51

Repisa cristal transparente

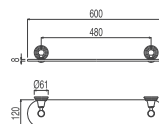

Cr	1.24.636.15
LV	5.24.636.15.51

Portarrollos sin tapa

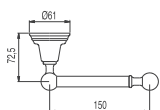

Cr	1.24.636.06
LV	5.24.636.06.51

Portavasos de pared cerámico

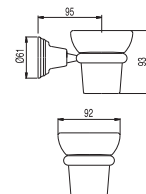

Cr	1.24.636.12
LV	5.24.636.12.51

Portavasos-jabonera de encimera cerámico

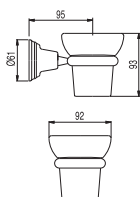

Cr	1.24.636.13
LV	5.24.636.13.51

Escobillero de suelo cerámico

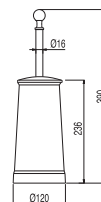

Cr	1.24.636.04
LV	5.24.636.04.51

Jabonera de pared cerámico

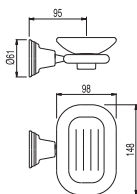

Cr	1.24.636.10
LV	5.24.636.10.51

Percha

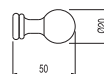

Cr	1.24.636.07
LV	5.24.636.07.51



TRES EXCLUSIVE

COCINA

- 168 Monomando
- 175 Con caño extraíble
- 178 Abatible
- 179 Electrónica
- 180 Mural
- 182 Bimando



RECAMBIOS DE LOS ARTÍCULOS EN:
www.tresgriferia.com

MÁS ALLÁ DE LA COCINA

La grifería de cocina debe ser, ante todo, funcional, pero este confort no va reñido con la voluntad de tener un elemento de decoración destacado dentro del espacio de cocina. El diseño y los acabados de acero o color aportan soluciones creativas y singulares para las nuevas tendencias estéticas en cocina.



Información sobre el color de los acabados en la página 624.

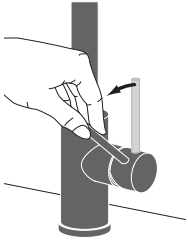

Maneta con rotación frontal.
Evita que la maneta choque contra la pared.

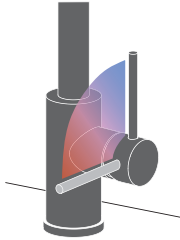

Ahorro energético Cold-Tres. El grifo se abre siempre en agua fría, evitando el encendido innecesario del calentador.

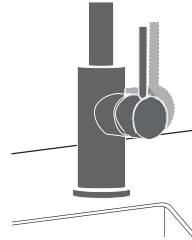

Instalación variable. La posición del monomando se puede instalar a la derecha o central según las necesidades personales.



Caño giratorio. Con completa libertad de movimiento a 360°.

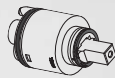

Cartucho cerámico Patentado.
El cartucho TRES evita el desgaste de los discos con el grifo cerrado, alargando la vida útil del mismo.



COCINA MONOMANDO

Ref.:

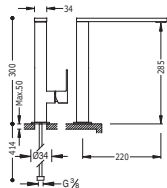

Monomando fregadero vertical
caño de 34x10 mm.



	Cr 1.06.486
--	-------------

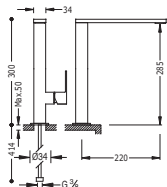

Monomando fregadero vertical
caño de 34x10 mm.



	Cr 1.06.486
1.06.486.AM	
1.06.486.NA	
1.06.486.RO	
1.06.486.VI	
1.06.486.FU	
1.06.486.VE	
6.06.486	
4.06.486	

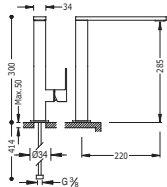

Monomando fregadero vertical
caño de 34x10 mm.



	Cr 1.06.486
Ac 5.06.486.03	
NLM 006.486.NM	
BM 006.486.BM	

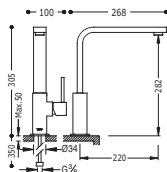

Monomando fregadero vertical
caño de 35x15 mm.



	Cr 1.30.496
--	-------------

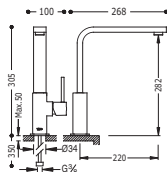

Monomando fregadero vertical
caño de 35x15 mm.



	Cr 1.30.496
Ac 5.30.496.03	
BM 030.496.BM	

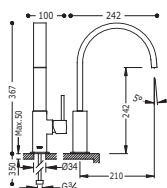

Monomando fregadero vertical
caño 35x15 mm. con aireador rectangular oculto



	Cr 1.30.496
--	-------------

Ref: |

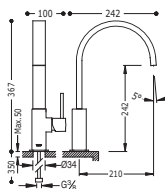

Monomando fregadero vertical
caño 35x15 mm. con aireador rectangular oculto



Ø 35 360° 91.30.190
Ac **5.30.498.03**
BM **030.498.BM**

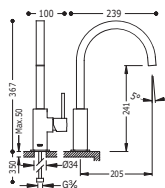

Monomando fregadero vertical
caño de 22x22 mm.



Ø 35 360° 91.30.190
Cr **1.30.497**

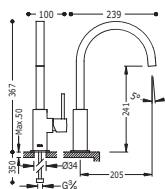

Monomando fregadero vertical
caño de 22x22 mm.



Ø 35 360° 91.30.190
1.30.497.AM
1.30.497.NA
1.30.497.RO
1.30.497.VI
1.30.497.FU
1.30.497.VE
6.30.497
4.30.497

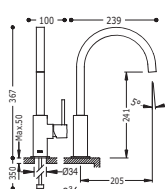

Monomando fregadero vertical
caño de 22x22 mm.



Ø 35 360° 91.30.190
Ac **5.30.497.03**
BM **030.497.BM**

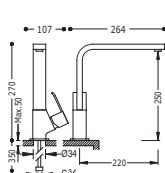

Monomando fregadero vertical
caño de 35x15 mm.



Ø 35 360° 91.07.190.05
Cr **1.06.440**

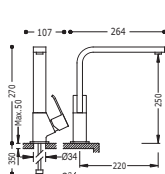

Monomando fregadero vertical
caño de 35x15 mm



Ø 35 360° 91.07.190.05
Ac **5.06.440.03**

Ref:

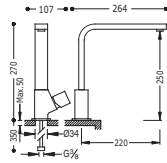

Monomando fregadero vertical
caño de 35x15 mm.

Cr 1.07.440

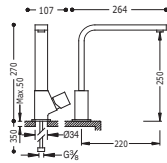

Monomando fregadero vertical
caño de 35x15 mm.

Ac 5.07.440.03

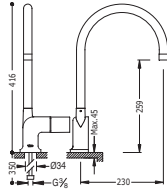

Monomando fregadero vertical



Cr 1.87.440

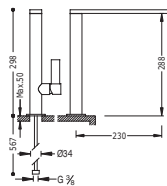

Monomando fregadero vertical
caño de 34x9 mm.



Cr 205.486.01

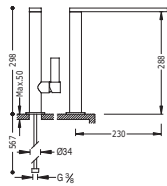

Monomando fregadero vertical
caño de 34x9 mm.



Ac 205.486.01.AC
NM 205.486.01.NM
BM 205.486.01.BM

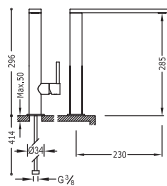

Monomando fregadero vertical
caño de 34x9 mm.



Cr 062.488.01

Ref: | |

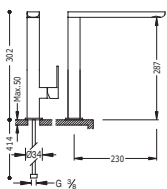

Monomando fregadero vertical
caño de 34x15 mm.



Cr | 200.440.01

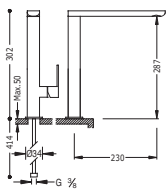

Monomando fregadero vertical
caño de 34x15 mm.



- 200.440.01.AM
- 200.440.01.NA
- 200.440.01.RO
- 200.440.01.VI
- 200.440.01.FU
- 200.440.01.VE
- 200.440.01.NE
- 200.440.01.BL

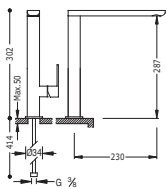

Monomando fregadero vertical
caño de 34x15 mm.



Ac | 200.440.01.AC

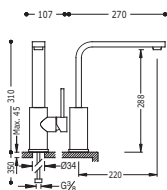

Monomando fregadero vertical
caño de 35x15 mm



Cr | 1.62.435

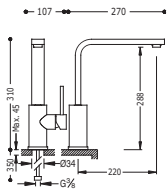

Monomando fregadero vertical
caño de 35x15 mm.



Ac | 062.435.AC
BM | 062.435.BM

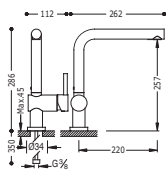

Monomando fregadero vertical



Cr | 1.30.336

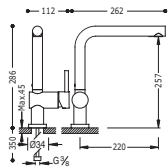

Monomando fregadero vertical



Ac 030.336.AC
BM 030.336.BM

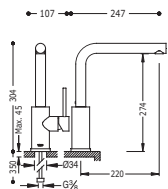

Monomando fregadero vertical



Cr 1.62.436

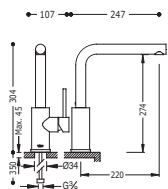

Monomando fregadero vertical



Ac 062.436.01.AC
BM 062.436.01.BM

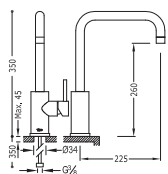

Monomando fregadero vertical



Cr 1.62.541

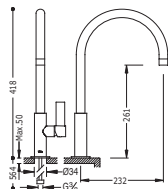

Monomando fregadero vertical



Cr 205.440.01

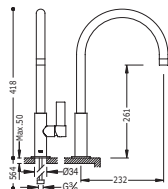

Monomando fregadero vertical



Ac 205.440.01.AC
NM 205.440.01.NM
BM 205.440.01.BM

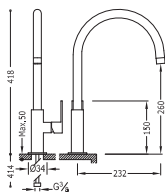

Monomando fregadero vertical



Cr | 200.440.02

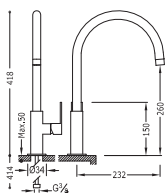

Monomando fregadero vertical



- 200.440.02.AM
- 200.440.02.NA
- 200.440.02.RO
- 200.440.02.VI
- 200.440.02.FU
- 200.440.02.VE
- 200.440.02.NE
- 200.440.02.BL

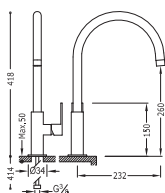

Monomando fregadero vertical



- AC | 200.440.02.AC
- NM | 200.440.02.NM
- BM | 200.440.02.BM

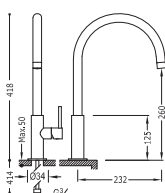

Monomando fregadero vertical



Cr | 062.542.01

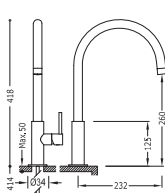

Monomando fregadero vertical



- AC | 062.542.01.AC
- BM | 062.542.01.BM

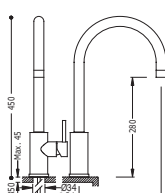

Monomando fregadero vertical



Cr | 1.62.540

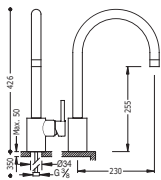

Monomando fregadero vertical

Cr 1.62.440		

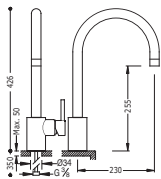

Monomando fregadero vertical

Ac 5.62.440.03		

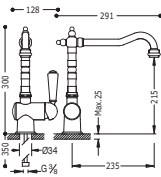

Monomando fregadero vertical

Cr 1.24.341		
Lv 5.24.341.01		
Ac 5.24.341.03		

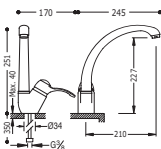

Monomando fregadero vertical

Cr 1.42.441.02		
Lv 5.42.441.02.01		
Ac 5.42.441.02.03		

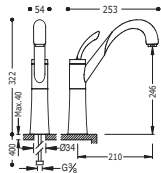

Monomando fregadero vertical

Cr 1.13.333		



COCINA EXTRAÍBLE

Ref.:

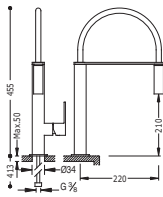

Monomando fregadero vertical
con rociador extraíble



Cr | 1.06.487

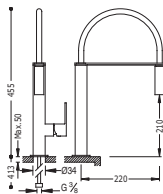

Monomando fregadero vertical
con rociador extraíble.



	1.06.487.AM
	1.06.487.NA
	1.06.487.RO
	1.06.487.VI
	1.06.487.FU
	1.06.487.VE
	6.06.487
	4.06.487

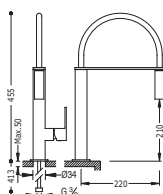

Monomando fregadero vertical
con rociador extraíble.



	5.06.487.03
	006.487.NM
	006.487.BM

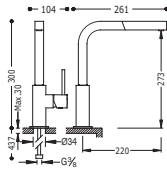

Monomando fregadero vertical con ducha extraíble

Cr 1.06.437

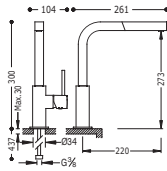

Monomando fregadero vertical con ducha extraíble.

Ac 5.06.437.03
Bm 006.437.BM

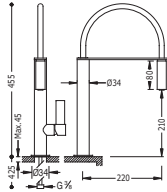

Monomando fregadero vertical con rociador extraíble



Cr 205.487.01

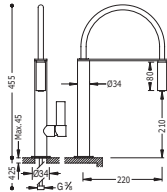

Monomando fregadero vertical con rociador extraíble.



Ac 205.487.01.AC
Nm 205.487.01.NM
Bm 205.487.01.BM

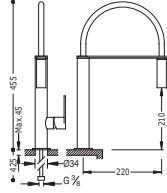

Monomando fregadero vertical con rociador extraíble



Cr 1.30.487

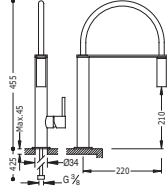

Monomando fregadero vertical con rociador extraíble



Cr 062.487.01

Ref: |

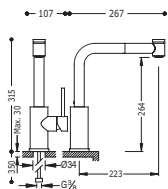

Monomando fregadero vertical
con ducha extraíble (2 funciones)



Cr | 1.62.438

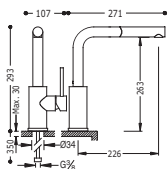

Monomando fregadero vertical
con ducha extraíble



Cr | 1.62.437

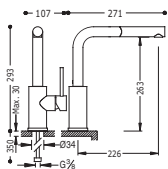

Monomando fregadero vertical
con ducha extraíble.



Ac | 5.62.4303

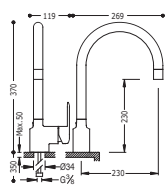

Monomando fregadero vertical
con rociador extraíble



Cr | 1.14.444

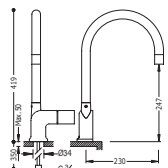

Monomando fregadero vertical
con rociador extraíble



Cr | 1.87.444

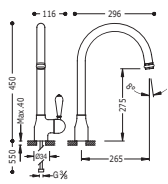

Monomando fregadera vertical
con rociador extraíble



Cr | 1.30.432



COCINA ABATIBLE

Ref.:

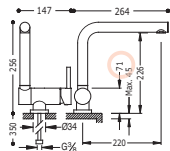

Monomando fregadero vertical ABATIBLE



Ø 35	360°	91.34.385.10	EUROPEAN UNION
Cr	1.30.335		

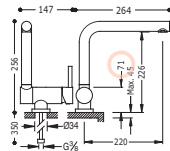

Monomando fregadero vertical ABATIBLE



Ø 35	360°	91.34.385.10	EUROPEAN UNION
Ac	030.335.AC		
NM	030.335.NM		
BM	030.335.BM		

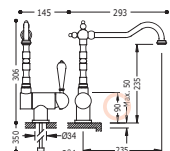

Monomando fregadero vertical ABATIBLE

Ø 35	360°	91.34.288	
Cr	1.24.334		
Lv	5.24.334.01		
Co	5.24.334.02		
Ac	5.24.334.03		



1.61.445
Un agua

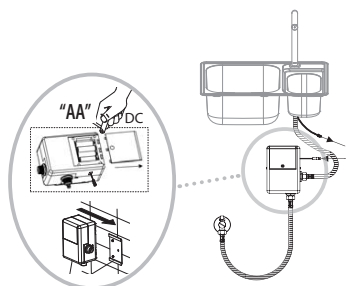

1.61.446
Mezclador

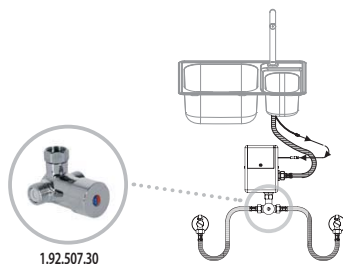

1.92.507.30

COCINA ELECTRÓNICA

Ref.:

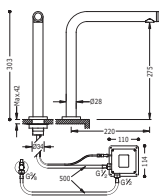

Fregadera electrónica 1 agua TOUCH-TRES
Sistema sensible al tacto. Sólo tocar (NO pulsar)



Cr | 1.61.445

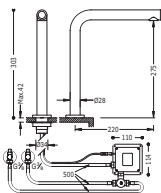

Fregadera electrónica mezclador TOUCH-TRES
Sistema sensible al tacto. Sólo tocar (NO pulsar). NOTA: Incluye un grifo mezclador dos aguas con tubos flexibles (ref. 1.92.507.30).



Cr | 1.61.446

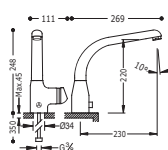

Monomando cocina electrónica
Mezclador



Cr | 1.92.445



COCINA MURAL

Ref:

Monomando mural

Cuerpo empotrado incluido e indivisible.

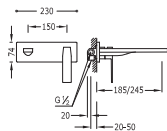

	91.30.190	(185 mm.)	
Cr		202.200.03	

	91.30.190	(245 mm.)	
Cr		202.200.04	

Monomando mural

Cuerpo empotrado incluido e indivisible.

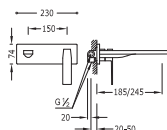

	91.30.190	(185 mm.)	
AC		202.200.03.AC	N
NM		202.200.03.NM	N
BM		202.200.03.BM	N

	91.30.190	(245 mm.)	
AC		202.200.04.AC	
NM		202.200.04.NM	N
BM		202.200.04.BM	N

Monomando mural

Cuerpo empotrado incluido e indivisible.

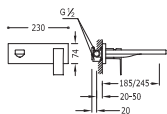

	91.30.190	(185 mm.)	
AC		006.200.03.AC	
NM		006.200.03.NM	N
BM		006.200.03.BM	N

	91.30.190	(245 mm.)	
AC		006.200.04.AC	
NM		006.200.04.NM	N
BM		006.200.04.BM	N

Monomando mural

Cuerpo empotrado incluido e indivisible.

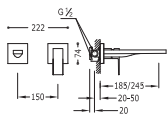

	91.30.190	(185 mm.)	
AC		006.200.12.AC	
NM		006.200.12.NM	N
BM		006.200.12.BM	N

	91.30.190	(245 mm.)	
AC		006.200.11.AC	
NM		006.200.11.NM	N
BM		006.200.11.BM	N

Ref:

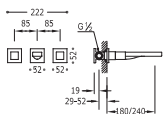

Bimando mural

Cuerpo empotrado incluido e indivisible.

	91.34.282 (180 mm.)
AC	008.153.01.AC
NM	008.153.01.NM
BM	008.153.01.BM
	91.34.282 (240 mm.)
AC	008.154.01.AC
NM	008.154.01.NM
BM	008.154.01.BM

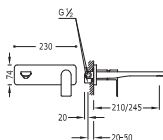

Monomando mural

Cuerpo empotrado incluido e indivisible.

	91.30.190 (245 mm.)
AC	200.200.02.AC
NM	200.200.02.NM
BM	200.200.02.BM

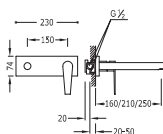

Monomando mural

Cuerpo empotrado incluido e indivisible.

	91.30.190 (210 mm.)
AC	205.200.41.AC
	91.30.190 (250 mm.)
AC	205.200.01.AC

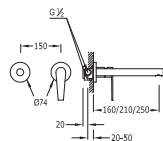

Monomando mural

Cuerpo empotrado incluido e indivisible.

	91.30.190 (210 mm.)
AC	205.200.71.AC
	91.30.190 (250 mm.)
AC	205.200.02.AC

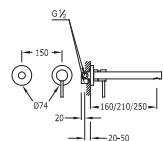

Monomando mural

Cuerpo empotrado incluido e indivisible.

	91.30.190 (210 mm.)
AC	062.200.71.AC
	91.30.190 (250 mm.)
AC	062.200.03.AC

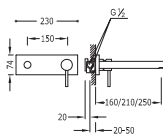

Monomando mural

Cuerpo empotrado incluido e indivisible.

	91.34.592 (210 mm.)
AC	062.200.02.AC
	91.34.592 (250 mm.)
AC	062.200.AC
BM	062.200.BM



COCINA BIMANDO

Ref.:

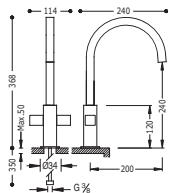

Bimando fregadero vertical
caño de 22x22 mm.



Cr 1.08.497

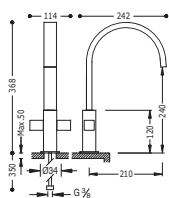

Bimando fregadero vertical
caño 35x15 mm. con aireador rectangular oculto



Cr 1.08.498

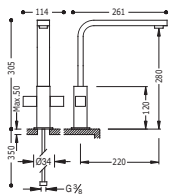

Bimando fregadero vertical
caño de 35x15 mm.



Cr 1.08.496

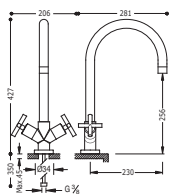

Bimando fregadero vertical



Cr 1.63.333

Ref: | |

Bimando fregadero vertical



Cr	1.24.342.61	
LV	5.24.342.01.61	
CG	5.24.342.02.61	
ACI	5.24.342.03.61	

Bimando fregadero vertical

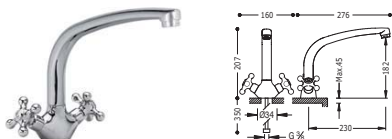

Cr	1.32.335	
----	----------	--

Bimando fregadero vertical

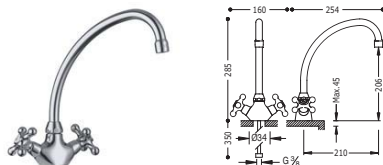

Cr	1.32.342	
LV	5.32.342.01	

Grupo fregadero pared

Distancia a pared de 250 mm.

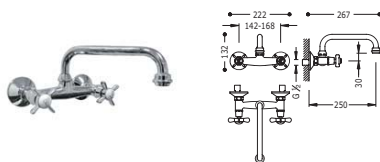

Cr	024.215.01	
----	------------	--

Grupo fregadero pared

Distancia a pared de 250 mm.

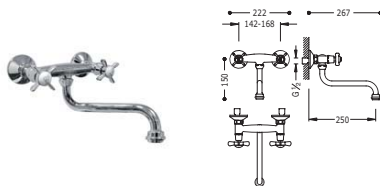

Cr	024.310.01	
----	------------	--

Grupo fregadero pared

Distancia a pared de 330 mm.



Cr	1.32.416	
----	----------	--



TRES EXCLUSIVE

ESPACIO DUCHA - ESPACIO BAÑERA



188 Block system

254 Shower Technology

286 Mono-Term

296 3v

BLOCK
SYSTEM



RECAMBIOS DE LOS ARTÍCULOS EN:
www.tresgriferia.com

¿CUÁNTAS VÍAS DE SALIDA DE AGUA DESEA?

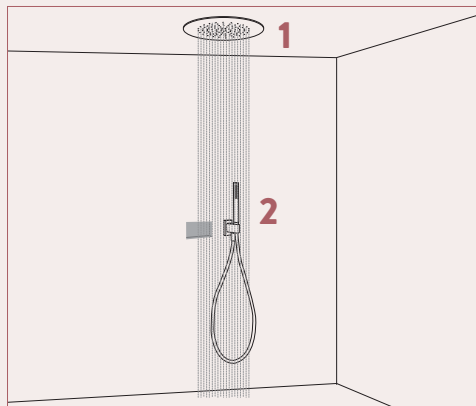
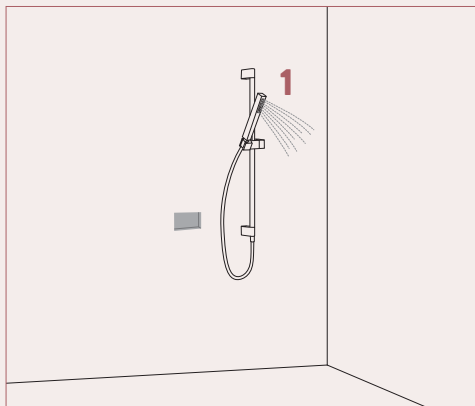

ELECCIÓN DEL SISTEMA DE CONTROL

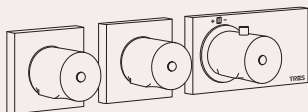

BLOCK SYSTEM

1 2 3 4 >> VÍAS DISPONIBLES

Termostática empotrada de gran simplicidad y belleza, con volante de temperatura preciso y volante/s para el control del caudal.

pg. 188 >>

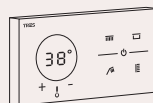

SHOWER TECHNOLOGY

2 3 4 >> VÍAS DISPONIBLES

Control electrónico termostático que regula la temperatura y las diferentes salidas del agua digitalmente, con solo un toque.

pg. 254 >>

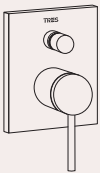
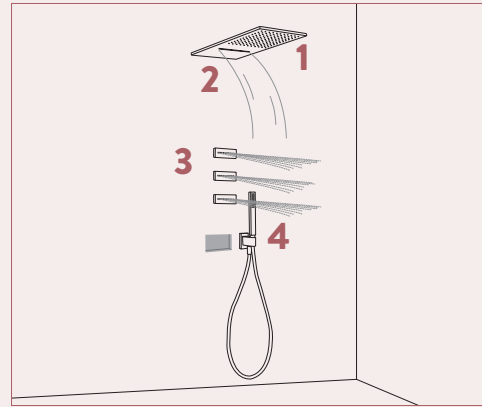
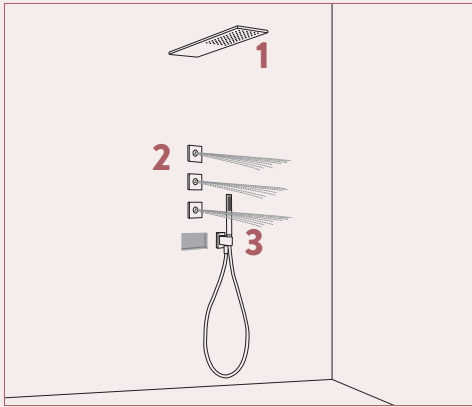

MONO-TERM

1 2 >> VÍAS DISPONIBLES

El manejo es como el de los monomandos pero ofrece unas prestaciones similares a las de una termostática.

pg. 286 >>

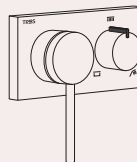

3V

3 >> VÍAS DISPONIBLES

Con el movimiento de un solo mando, controla la temperatura y caudal. Y el selector de funciones ofrece hasta tres salidas de agua.

pg. 296 >>





TERMOSTÁTICAS EMPOTRADAS QUE MARCAN TENDENCIA

La gama de termostáticas empotradas de TRES otorga al baño un ambiente exquisito para el confort que se espera en él. Con su sistema de anclaje interno se simplifica el montaje para que quede perfectamente alineado.

TECNOLOGIA Y ELEGANCIA EN LA DUCHA

Termostática empotrada de alto nivel estético.

Cartucho termostático tres instant 57®, de difícil obstrucción, alta durabilidad y con protección anticalcárea.

Cartuchos distribuidores integrados de 1 a 4 vías. A partir de 3 vías, posibilidad de usar dos vías simultáneas.



FÁCIL DE INSTALAR

Fácil instalación y alineación de los elementos.

Si el control y el soporte de ducha se compran por individual, éstos pueden alinearse fácilmente o bién instalarlos por separado. Los jets de hidromasaje (si los hay) se pueden alinear con el resto del cuerpo empotrado gracias a los perfiles de instalación.

En los kits, el control y el soporte de ducha estan integrados en un solo cuerpo empotrado no divisible.

Se suministra completamente montado de fábrica.

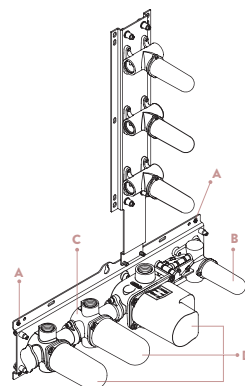

block system® horizontal

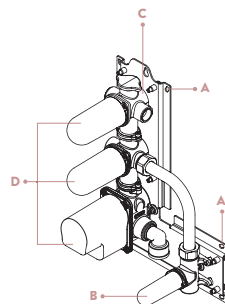

block system® vertical

- A** Perfil de instalación a muro o pladur con 3 ejes de nivelación.
- B** Soporte con toma de ducha integrado.
- C** Amortiguadores anti-vibración.
- D** Protectores estancos. La pared queda protegida de humedad.



Ref:

Termostática empotrar BLOCK SYSTEM

con cierre y regulación de caudal.

- Cuerpo empotrado termostático incluido.

* NOTA: Es obligatorio añadir en el pedido un rociador, ducha de mano, jets o un caño bañera, dependiendo del tipo de instalación.

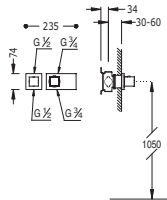

299.250.45 1 vía

Cr ***207.251.99**

299.250.45 2 vías

Cr ***207.252.99**



Termostática empotrar BLOCK SYSTEM

con cierre y regulación de caudal.

- Cuerpo empotrado termostático incluido.

* NOTA: Es obligatorio añadir en el pedido un rociador, ducha de mano, jets o un caño bañera, dependiendo del tipo de instalación.

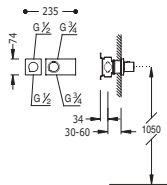

299.195.03 1 vía

Cr ***207.351.99**

299.195.03 2 vías

Cr ***207.352.99**



PARA 1-2 VÍAS

Termostática empotrar BLOCKSYSTEM

con cierre y regulación de caudal.

- Cuerpo empotrado termostático incluido.

* NOTA: Es obligatorio añadir en el pedido un rociador, ducha de mano, jets o un caño bañera, dependiendo del tipo de instalación.

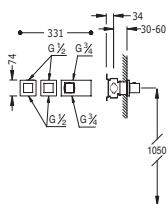

299.250.45  **3 vías**

Cr | *207.253.99 |

299.250.45  **4 vías**

Cr | *207.254.99 |



Termostática empotrar BLOCKSYSTEM

con cierre y regulación de caudal.

- Cuerpo empotrado termostático incluido.

* NOTA: Es obligatorio añadir en el pedido un rociador, ducha de mano, jets o un caño bañera, dependiendo del tipo de instalación.

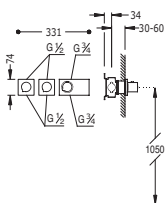

299.195.03  **3 vías**

Cr | *207.353.99 |

299.195.03  **4 vías**

Cr | *207.354.99 |



Soporte para ducha BLOCK SYSTEM

con toma de agua a pared regulable en profundidad, válvula antirretorno, cuerpo empotrado incluido y perfil de instalación.

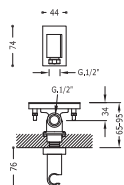

 **207.182.02**

Cr |

PARA 1-2 VÍAS

Ref.:

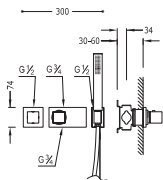

Termostática empotrar BLOCK SYSTEM

- con cierre y regulación de caudal.
- Cuerpo empotrado termostático incluido.
- Ducha móvil anticalcárea (202.639.01).
- Flexo SATIN (91.34.609.15).
- * NOTA: Es obligatorio añadir en el pedido un rociador, jets o un caño bañera, dependiendo del tipo de instalación.

299.250.45	REINARCA	1 vía
Cr	207.251.91	

299.250.45	REINARCA	2 vías
Cr	*207.252.91	

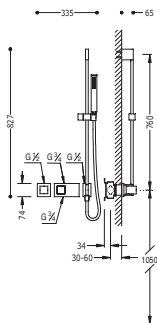

Termostática empotrar BLOCK SYSTEM

- con cierre y regulación de caudal.
- Cuerpo empotrado termostático incluido.
- Barra deslizante con toma de agua a pared. Long 760 mm.
- Ducha móvil anticalcárea (202.639.01).
- Flexo SATIN (91.34.609.15).
- * NOTA: Es obligatorio añadir en el pedido un rociador, jets o un caño bañera, dependiendo del tipo de instalación.

299.250.45	REINARCA	1 vía
Cr	207.251.92	

299.250.45	REINARCA	2 vías
Cr	*207.252.92	



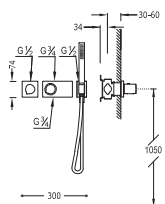

Termostática empotrar BLOCK SYSTEM

con cierre y regulación de caudal.
 - Cuerpo empotrado termostático incluido.
 - Ducha móvil anticalcárea (034.116.01).
 - Flexo SATIN (91.34.609.15).

* NOTA: Es obligatorio añadir en el pedido un rociador, jets o un caño bañera, dependiendo del tipo de instalación.

299.195.03	REGABOX	1 vía
------------	---------	-------

Cr | *207.351.91 |

299.195.03	REGABOX	2 vías
------------	---------	--------

Cr | *207.352.91 |

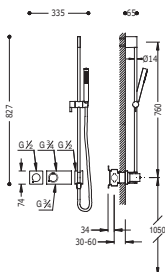

Termostática empotrar BLOCK SYSTEM

con cierre y regulación de caudal.
 - Cuerpo empotrado termostático incluido.
 - Barra deslizante con toma de agua a pared. Long. 760 mm.
 - Ducha móvil anticalcárea (034.116.01).
 - Flexo SATIN (91.34.609.15).

* NOTA: Es obligatorio añadir en el pedido un rociador, jets o un caño bañera, dependiendo del tipo de instalación.

299.195.03	REGABOX	1 vía
------------	---------	-------

Cr | *207.351.92 |

299.195.03	REGABOX	2 vías
------------	---------	--------

Cr | *207.352.92 |



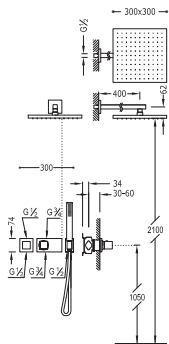

Kit de ducha termostático empotrado BLOCK SYSTEM

- con cierre y regulación de caudal (2 vías).
- Cuerpo empotrado termostático incluido.
- Ducha fija 300x300 mm. con rótula (1.34.138.30). Material Latón.
- Ducha móvil anticalcárea (202.639.01).
- Flexo SATIN (91.34.609.15).



Cr 207.252.01

N

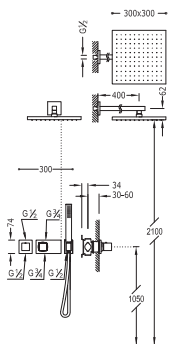

Kit de ducha termostático empotrado BLOCK SYSTEM

- con cierre y regulación de caudal (2 vías).
- Cuerpo empotrado termostático incluido.
- Ducha fija 300x300 mm. con rótula. Material Latón.
- Ducha móvil anticalcárea.
- Flexo.



Ac	299.250.45.AC
NM	299.250.45.NM
BM	299.250.45.BM
Ac	207.252.01.AC
NM	207.252.01.NM
BM	207.252.01.BM

Kit de ducha termostático empotrado BLOCK SYSTEM

- con cierre y regulación de caudal (2 vías).
- Cuerpo empotrado termostático incluido.
- Rociador ducha INOX a pared 210x550 mm. (299.903.02).
- Ducha móvil anticalcárea (202.639.01).
- Flexo SATIN (91.34.609.15).

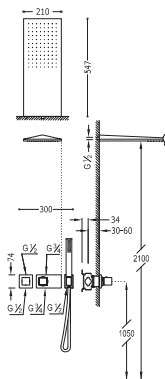

299.250.45  **207.252.02**

Kit de ducha termostático empotrado BLOCK SYSTEM

- con cierre y regulación de caudal (2 vías).
- Cuerpo empotrado termostático incluido.
- Rociador ducha INOX a pared 210x550 mm.
- Ducha móvil anticalcárea.
- Flexo.

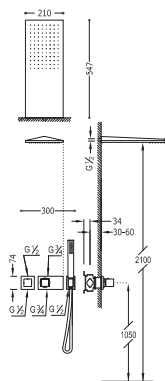

299.250.45 NE  **207.252.02.NE**
 299.250.45 BL **207.252.02.BL**

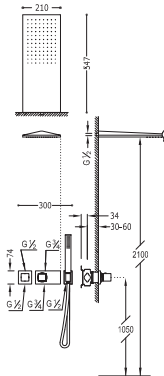

Kit de ducha termostático empotrado BLOCK SYSTEM

- con cierre y regulación de caudal (2 vías).
- Cuerpo empotrado termostático incluido.
- Rociador ducha INOX a pared 210x550 mm.
- Ducha móvil anticalcárea.
- Flexo.

299.250.45.AC
Ac 207.252.02.AC

299.250.45.NM	299.250.45.BM
NM 207.252.02.NM	BM 207.252.02.BM

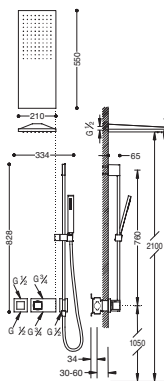

Kit de ducha termostático empotrado BLOCK SYSTEM

- con cierre y regulación de caudal (2 vías).
- Cuerpo empotrado termostático incluido.
- Rociador ducha INOX a pared 210x550 mm. (299.903.02).
- Barra deslizante con toma de agua a pared. Long 760 mm.
- Ducha móvil anticalcárea (202.639.01).
- Flexo SATIN (91.34.609.15).

299.250.45
Cr 207.252.10



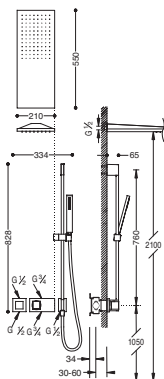

Kit de ducha termostático empotrado BLOCK SYSTEM

- con cierre y regulación de caudal (2 vías).
- Cuerpo empotrado termostático incluido.
- Rociador ducha INOX a pared 210x550 mm.
- Barra deslizante con toma de agua a pared. Long 760 mm.
- Ducha móvil anticalcárea.
- Flexo.

Ac 299.250.45.AC
 Nm 299.250.45.NM
 BM 299.250.45.BM

Ac 207.252.10.AC

NM 207.252.10.NM

BM 207.252.10.BM



Kit de ducha termostático empotrado BLOCK SYSTEM

- con cierre y regulación de caudal (2 vías).
- Cuerpo empotrado termostático incluido.
- Caño cascada INOX (299.903.04).
- Ducha móvil anticalcárea (202.639.01).
- Flexo SATIN (91.34.609.15).

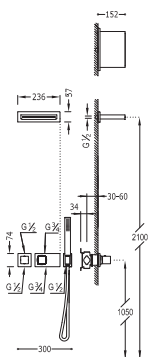

299.250.45
 BELGARA
 Cr 207.252.03



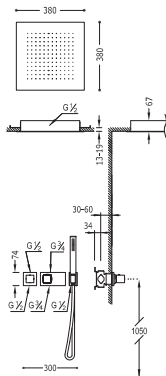

Kit de ducha termostático empotrado BLOCK SYSTEM

- con cierre y regulación de caudal (2 vías).
- Cuerpo empotrado termostático incluido.
- Rociador ducha INOX a techo 380x380 mm. (1.34.944).
- Ducha móvil anticalcárea (202.639.01).
- Flexo SATIN (91.34.609.15).



N

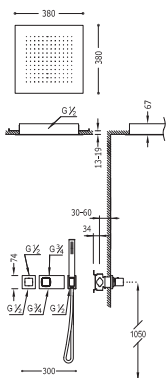

Kit de ducha termostático empotrado BLOCK SYSTEM

- con cierre y regulación de caudal (2 vías).
- Cuerpo empotrado termostático incluido.
- Rociador ducha INOX a techo 380x380 mm.
- Ducha móvil anticalcárea.
- Flexo.



	Ac 299.250.45.AC	
	NM 299.250.45.NM	
AC	207.252.04.AC	
NM	207.252.04.NM	
BM	207.252.04.BM	

Kit de ducha termostático empotrado BLOCK SYSTEM

- con cierre y regulación de caudal (2 vías).
- Cuerpo empotrado termostático incluido.
- Rociador ducha INOX a techo 500x500 mm. (299.953.02).
- Ducha móvil anticálrea (202.639.01).
- Flexo SATIN (91.34.609.15).

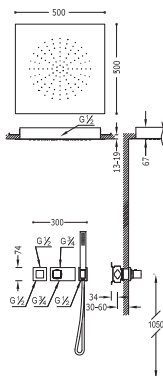

299.250.45 BELGARDIA

Cr | 207.252.08 |

Kit de ducha termostático empotrado BLOCK SYSTEM

- con cierre y regulación de caudal (2 vías).
- Cuerpo empotrado termostático incluido.
- Rociador ducha INOX a techo 500x500 mm. (299.953.02).
- Barra deslizante con toma de agua a pared. Long 760 mm.
- Ducha móvil anticálrea (202.639.01).
- Flexo SATIN (91.34.609.15).

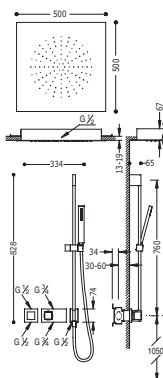

299.250.45 BELGARDIA

Cr | 207.252.09 |

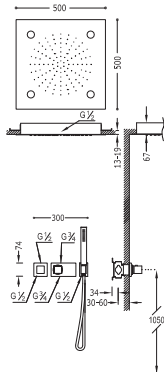

Kit de ducha termostático empotrado BLOCK SYSTEM CROMOTERAPIA

- con cierre y regulación de caudal (2 vías).
- Cuerpo empotrado termostático incluido.
- Rociador ducha INOX a techo 500x500 mm. (299.962.01).
- Ducha móvil anticalcárea (202.639.01).
- Flexo SATIN (91.34.609.15).











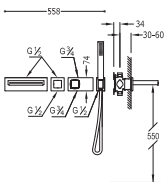

299.250.45

Cr 207.252.05



Kit de bañera termostático empotrado BLOCK SYSTEM

- con cierre y regulación de caudal (2 vías).
- Cuerpo empotrado termostático incluido.
- Caño cascada INOX.
- Ducha móvil anticalcárea (202.639.01).
- Flexo SATIN (91.34.609.15).











299.250.45

Cr 207.192.01

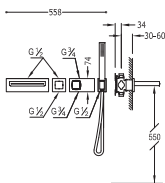

Kit de bañera termostático empotrado BLOCK SYSTEM

- con cierre y regulación de caudal (2 vías).
- Cuerpo empotrado termostático incluido.
- Caño cascada INOX.
- Ducha móvil anticalcárea.
- Flexo.



 Ac 299.250.45.AC
 Nm 299.250.45.NM
 Bm 299.250.45.BM

AC	207.192.01.AC
NM	207.192.01.NM
BM	207.192.01.BM



Kit de bañera termostático empotrado BLOCK SYSTEM

- con cierre y regulación de caudal (2 vías).
- Cuerpo empotrado termostático incluido.
- Desagüe bañera y válvula de llenado cuadrada CASCADA con rebosadero (1.34.534.40).
- Sifón PVC bañera (1.34.634.60).
- Ducha móvil anticalcárea (202.639.01).
- Flexo SATIN (91.34.609).

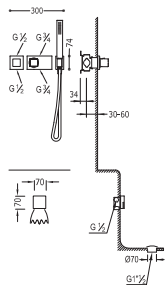

 299.250.45
 207.252.06



Kit de bañera termostático empotrado BLOCK SYSTEM

- con cierre y regulación de caudal (2 vías).
- Cuerpo empotrado termostático incluido.
- Desague bañera y válvula de llenado cuadrada CASCADA con rebosadero (1.34.534.40).
- Sifón PVC bañera (1.34.634.60).
- Ducha móvil anticalcárea (202.639.01).
- Flexo doble engatillado.

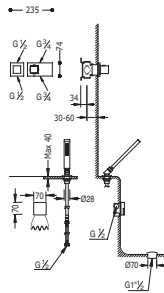

Cr **207.252.07**

Kit de ducha termostático empotrado BLOCK SYSTEM

- con cierre y regulación de caudal (2 vías).
- Cuerpo empotrado termostático incluido.
- Ducha fija Ø 300 mm. con rótula. Material Latón (1.34.137.30).
- Ducha móvil anticalcárea (034.116.01).
- Flexo SATIN (91.34.609.15).

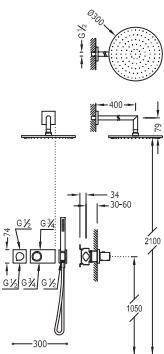

Cr **207.352.01**

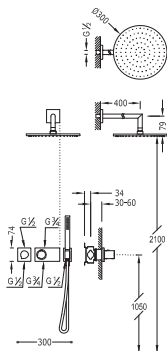

Kit de ducha termostático empotrado BLOCK SYSTEM

- con cierre y regulación de caudal (2 vías).
- Cuerpo empotrado termostático incluido.
- Ducha fija Ø 300 mm. con rótula. Material Latón.
- Ducha móvil anticálrea.
- Flexo.

299.195.03.NM

NM 207.352.01.NM

Ac 299.195.03.AC
 BM 299.195.03.BM
 TAM 299.195.03.TAM
 TNA 299.195.03.TNA
 TRO 299.195.03.TRO
 TVI 299.195.03.TVI
 TFM 299.195.03.TFM
 TNE 299.195.03.TNE
 TBL 299.195.03.TBL

Ac **207.352.01.AC**

Bm **207.352.01.BM**

Tam **207.352.01.TAM**

Tna **207.352.01.TNA**

Tro **207.352.01.TRO**

Tvi **207.352.01.TVI**

Tfu **207.352.01.TFU**

Tve **207.352.01.TVE**

Tne **207.352.01.TNE**

Tbl **207.352.01.TBL**

ECO TRÉS BLOCK SYSTEM TRÉS RESIST 57 easy clean

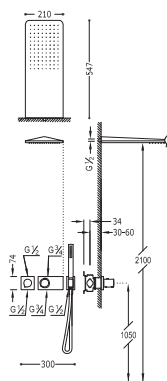

Kit de ducha termostático empotrado BLOCK SYSTEM

- con cierre y regulación de caudal (2 vías).
- Cuerpo empotrado termostático incluido.
- Rociador ducha INOX a pared 210x550 mm. (299.903.07).
- Ducha móvil anticálrea (034.116.01).
- Flexo SATIN (91.34.609.15).

299.195.03

Cr **207.352.02**

ECO TRÉS BLOCK SYSTEM TRÉS RESIST 57 easy clean

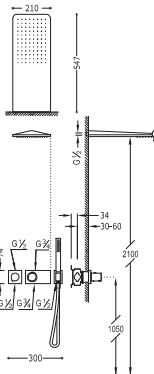

Kit de ducha termostático empotrado BLOCK SYSTEM

- con cierre y regulación de caudal (2 vías).
- Cuerpo empotrado termostático incluido
- Rociador ducha INOX a pared 210x550 mm.
- Ducha móvil anticalcárea.
- Flexo.

299.195.03.NM
NM 207.352.02.NM

Ac 299.195.03.AC
 BM 299.195.03.BM

AC 207.352.02.AC
BM 207.352.02.BM

ECO TRES BLOCK SYSTEM TRES POLIDRIP 37 easy CLEAN INOX

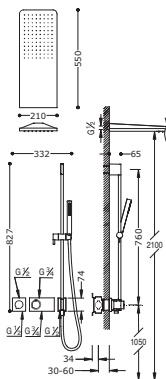

Kit de ducha termostático empotrado BLOCK SYSTEM

- con cierre y regulación de caudal (2 vías).
- Cuerpo empotrado termostático incluido.
- Rociador ducha INOX a pared 210x550 mm. (299.903.07).
- Barra deslizante con toma de agua a pared. Long 760 mm.
- Ducha móvil anticalcárea (034.116.01).
- Flexo SATIN (01.34.609.15).

299.195.03
Cr 207.352.10

ECO TRES BLOCK SYSTEM TRES POLIDRIP 37 easy CLEAN INOX

N

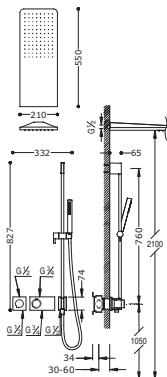

Kit de ducha termostático empotrado BLOCK SYSTEM

- con cierre y regulación de caudal (2 vías).
- Cuerpo empotrado termostático incluido.
- Rociador ducha INOX a pared 210x550 mm.
- Barra deslizante con toma de agua a pared. Long 760 mm.
- Ducha móvil anticalcárea.
- Flexo.

Ac 299.195.03.AC
 Nm 299.195.03.NM
 Bm 299.195.03.BM

Ac | 207.352.10.AC

Nm | 207.352.10.NM

Bm | 207.352.10.BM

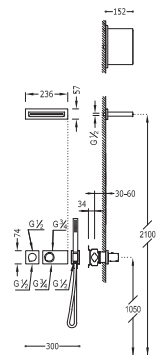

Kit de ducha termostático empotrado BLOCK SYSTEM

- con cierre y regulación de caudal (2 vías).
- Cuerpo empotrado termostático incluido.
- Caño cascada INOX (299.903.04).
- Ducha móvil anticalcárea (034.116.01).
- Flexo SATIN (91.34.609.15).

299.195.03
 Cr | 207.352.03



BLOCK SYSTEM





Kit de ducha termostático empotrado BLOCK SYSTEM

- con cierre y regulación de caudal (2 vías).
- Cuerpo empotrado termostático incluido.
- Rociador ducha INOX a techo Ø 380 mm. (1.34.940).
- Ducha móvil anticalcárea (034.116.01).
- Flexo SATIN (91.34.609.15).

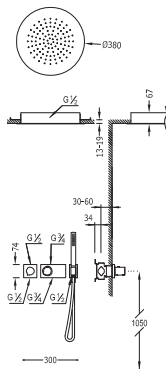

299 195 03
 21014434
Cr 207.352.04

N



Kit de ducha termostático empotrado BLOCK SYSTEM

- con cierre y regulación de caudal (2 vías).
- Cuerpo empotrado termostático incluido.
- Rociador ducha INOX a techo Ø 380 mm.
- Ducha móvil anticalcárea.
- Flexo.

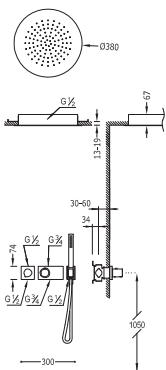

Ac 299 195 03 AC
 NM 299 195 03 NM
 BM 299 195 03 BM

Ac	207.352.04.AC
NM	207.352.04.NM
BM	207.352.04.BM



Kit de ducha termostático empotrado BLOCK SYSTEM

- con cierre y regulación de caudal (2 vías).
- Cuerpo empotrado termostático incluido.
- Rociador ducha INOX a techo Ø 500 mm. (1.34.950).
- Ducha móvil anticálcarea (034.116.01).
- Flexo SATIN (91.34.609.15).

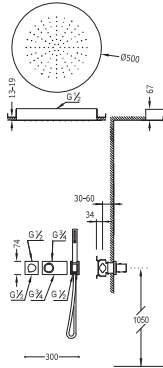

Kit de ducha termostático empotrado BLOCK SYSTEM

- con cierre y regulación de caudal (2 vías).
- Cuerpo empotrado termostático incluido.
- Rociador ducha INOX a techo Ø 500 mm. (1.34.950).
- Barra deslizante con toma de agua a pared. Long.760 mm.
- Ducha móvil anticálcarea (034.116.01).
- Flexo SATIN (91.34.609.15).

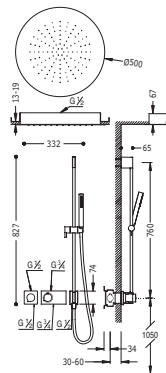



Kit de ducha termostático empotrado BLOCK SYSTEM CROMOTERAPIA

- con cierre y regulación de caudal (2 vías).
- Cuerpo empotrado termostático incluido.
- Rociador ducha INOX a techo 500x500 mm. (299.962.01).
- Ducha móvil anticalcárea (034.116.01).
- Flexo SATIN (91.34.609.15).

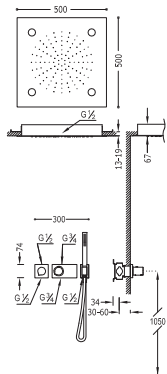

Kit de bañera termostático empotrado BLOCK SYSTEM

- con cierre y regulación de caudal (2 vías).
- Cuerpo empotrado termostático incluido.
- Caño cascada INOX.
- Ducha móvil anticalcárea (034.116.01).
- Flexo SATIN (91.34.609.15).

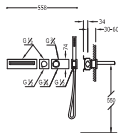

299.195.03 **RECORADA**
Cr 207.352.05

299.195.03 **RECORADA**
Cr 207.392.01

N

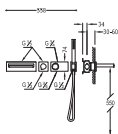

Kit de bañera termostático empotrado BLOCK SYSTEM

- con cierre y regulación de caudal (2 vías).
- Cuerpo empotrado termostático incluido.
- Caño cascada INOX.
- Ducha móvil anticalcárea.
- Flexo.

Al 299.195.03.AC
 Nm 299.195.03.NM
 BM 299.195.03.BM

AC	207.392.01.AC		
NM	207.392.01.NM		
BM	207.392.01.BM		

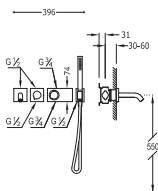

Kit de bañera termostático empotrado BLOCK SYSTEM

- con cierre y regulación de caudal (2 vías).
- Cuerpo empotrado termostático incluido.
- Caño bañera.
- Ducha móvil anticalcárea (034.116.01).
- Flexo SATIN (91.34.609.15).

299.195.03 BELGANDA
 Cr | 207.352.09





Kit de bañera termostático empotrado BLOCK SYSTEM

- con cierre y regulación de caudal (2 vías).
- Cuerpo empotrado termostático incluido.
- Caño bañera.
- Ducha móvil anticalcárea (034.116.01).
- Flexo SATIN (91.34.609.15).

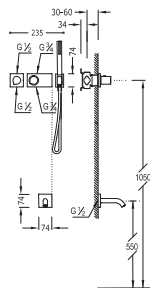

Cr 207.352.08

N



Kit de bañera termostático empotrado BLOCK SYSTEM

- con cierre y regulación de caudal (2 vías).
- Cuerpo empotrado termostático incluido.
- Caño bañera.
- Ducha móvil anticalcárea.
- Flexo.

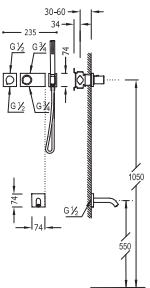

	Ac 299.195.03.AC
	NM 299.195.03.NM
	BM 299.195.03.BM
Ac	207.352.08.AC
NM	207.352.08.NM
BM	207.352.08.BM

Kit de bañera termostático empotrado BLOCK SYSTEM

- con cierre y regulación de caudal (2 vías).
- Cuerpo empotrado termostático incluido.
- Desagüe bañera y válvula de llenado redonda CASCADA con rebosadero (1.34.534.30).
- Sifón PVC bañera (1.34.634.60).
- Ducha móvil anticalcárea (034.116.01).
- Flexo SATIN (91.34.609).

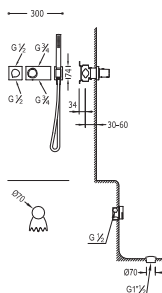

Cr | 207.352.00

Kit de bañera termostático empotrado BLOCK SYSTEM

- con cierre y regulación de caudal (2 vías).
- Cuerpo empotrado termostático incluido.
- Desagüe bañera y válvula de llenado redonda CASCADA con rebosadero (1.34.534.30).
- Sifón PVC bañera (1.34.634.60).
- Ducha masaje, 5 posiciones. (299.631.06).
- Flexo doble engatillado.

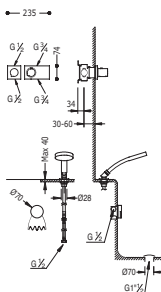

Cr | 207.352.07

PARA 3-4 VÍAS

Ref:

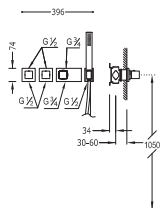

Termostática empotrar BLOCK SYSTEM

- con cierre y regulación de caudal.
 - Cuerpo empotrado termostático incluido.
 - Ducha móvil anticalcárea (202.639.01).
 - Flexo SATIN (91.34.609.15).
- NOTA: Es obligatorio añadir en el pedido unos jets o un caño bañera, dependiendo del tipo de instalación.

		299.250.45	BAÑADERA	3 vías
Cr				207.253.91

		299.250.45	BAÑADERA	4 vías
Cr				207.254.91

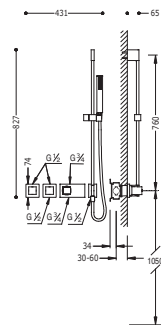

Termostática empotrar BLOCK SYSTEM

- con cierre y regulación de caudal.
 - Cuerpo empotrado termostático incluido.
 - Barra deslizante con toma de agua a pared. Long 760 mm.
 - Ducha móvil anticalcárea (202.639.01).
 - Flexo SATIN (91.34.609.15).
- NOTA: Es obligatorio añadir en el pedido unos jets o un caño bañera, dependiendo del tipo de instalación.

		299.250.45	BAÑADERA	3 vías
Cr				207.253.92

		299.250.45	BAÑADERA	4 vías
Cr				207.254.92



Termostática empotrar BLOCK SYSTEM

- con cierre y regulación de caudal.
- Cuerpo empotrado termostático incluido.
- Ducha móvil anticálcarea (034.116.01).
- Flexo SATIN (91.34.609.15).

NOTA: Es obligatorio añadir en el pedido unos jets o un caño bañera, dependiendo del tipo de instalación.

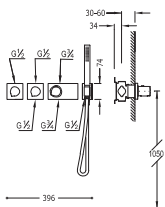

299.195.03 3 vías

Cr | 207.353.91 |

299.195.03 4 vías

Cr | 207.354.91 |



Termostática empotrar BLOCK SYSTEM

- con cierre y regulación de caudal.
- Cuerpo empotrado termostático incluido.
- Barra deslizante con toma de agua a pared. Long 760 mm.
- Ducha móvil anticálcarea (034.116.01).
- Flexo SATIN (91.34.609.15).

NOTA: Es obligatorio añadir en el pedido unos jets o un caño bañera, dependiendo del tipo de instalación.

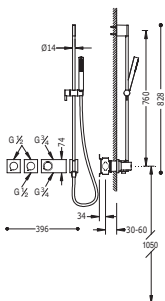

299.195.03 3 vías

Cr | 207.353.92 |

299.195.03 4 vías

Cr | 207.354.92 |



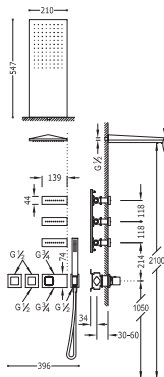

Kit de ducha termostático empotrado BLOCK SYSTEM

- con cierre y regulación de caudal (3 vías).
- Cuerpo empotrado termostático incluido.
- Rociador ducha INOX a pared 210x550 mm. (299.903.02).
- 3 jets antical.
- Ducha móvil anticalcárea (202.639.01).
- Flexo SATIN (91.34.609.15).

IMPORTANTE: Montar un desagüe de >50 l/min.



Cr 207.253.01

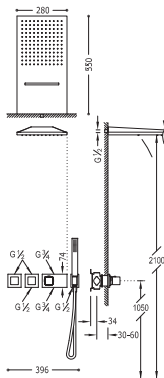

Kit de ducha termostático empotrado BLOCK SYSTEM

- con cierre y regulación de caudal (3 vías).
- Cuerpo empotrado termostático incluido.
- Rociador ducha INOX a pared con 2 tipos de chorro. 280x550 mm. (299.903.01).
- Ducha móvil anticalcárea (202.639.01).
- Flexo SATIN (91.34.609.15).

IMPORTANTE: Montar un desagüe de >50 l/min.



Cr 207.253.02

N

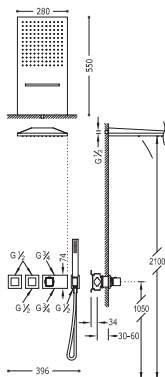

Kit de ducha termostático empotrado BLOCK SYSTEM

- con cierre y regulación de caudal (3 vías).
- Cuerpo empotrado termostático incluido.
- Rociador ducha INOX a pared con 2 tipos de chorro. 280x550 mm.
- Ducha móvil anticalcárea.
- Flexo.

IMPORTANTE: Montar un desagüe de >50 l/min.

AC 299.250.45.AC
 NM 299.250.45.NM
 BM 299.250.45.BM

AC 207.253.02.AC

NM 207.253.02.NM

BM 207.253.02.BM

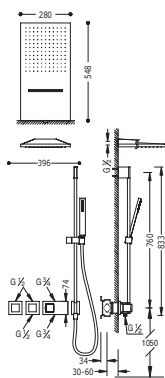

Kit de ducha termostático empotrado BLOCK SYSTEM

- con cierre y regulación de caudal (3 vías).
- Cuerpo empotrado termostático incluido.
- Rociador ducha INOX a pared con 2 tipos de chorro. 280x550 mm. (299.903.01).
- Barra deslizante con toma de agua a pared. Long 760 mm.
- Ducha móvil anticalcárea (202.639.01).
- Flexo SATIN (91.34.609.15).

IMPORTANTE: Montar un desagüe de >50 l/min.

299.250.45

Cr 207.253.09



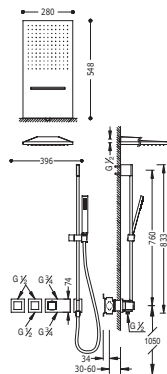

Kit de ducha termostático empotrado BLOCK SYSTEM

- con cierre y regulación de caudal (3 vías).
- Cuerpo empotrado termostático incluido.
- Rociador ducha INOX a pared con 2 tipos de chorro. 280x550 mm.
- Barra deslizante con toma de agua a pared. Long 760 mm.
- Ducha móvil anticalcárea.
- Flexo.

IMPORTANTE: Montar un desagüe de >50 l/min.

Ac	207.253.09.AC
NM	207.253.09.NM
BM	207.253.09.BM

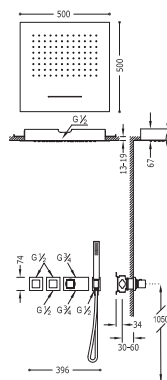

Kit de ducha termostático empotrado BLOCK SYSTEM

- con cierre y regulación de caudal (3 vías).
- Cuerpo empotrado termostático incluido.
- Rociador ducha INOX a techo con 2 tipos de chorro. 500x500 mm. (299.955.01).
- Ducha móvil anticalcárea (202.639.01).
- Flexo SATIN (91.34.609.15).

IMPORTANTE: Montar un desagüe de >50 l/min.

Cr	207.253.03
----	------------



N

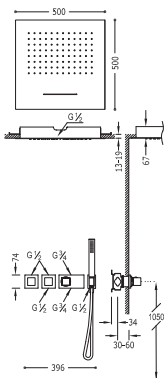

Kit de ducha termostático empotrado BLOCK SYSTEM

- con cierre y regulación de caudal (3 vías).
- Cuerpo empotrado termostático incluido.
- Rociador ducha INOX a techo con 2 tipos de chorro. 500x500 mm.
- Ducha móvil anticalcárea.
- Flexo.

IMPORTANTE: Montar un desagüe de >50 l/min.

Ac 299.250.45.AC
 Nm 299.250.45.NM
 Bm 299.250.45.BM

Ac | 207.253.03.AC

Nm | 207.253.03.NM

Bm | 207.253.03.BM

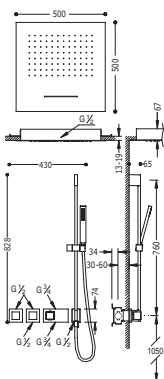

Kit de ducha termostático empotrado BLOCK SYSTEM

- con cierre y regulación de caudal (3 vías).
- Cuerpo empotrado termostático incluido.
- Rociador ducha INOX a techo con 2 tipos de chorro. 500x500 mm. (299.955.01).
- Barra deslizante con toma de agua a pared. Long 760 mm.
- Ducha móvil anticalcárea (202.639.01).
- Flexo SATIN (91.34.609.15).

IMPORTANTE: Montar un desagüe de >50 l/min.

299.250.45

Cr | 207.253.11



BLOCK SYSTEM



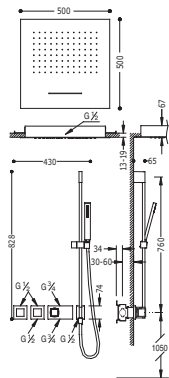

Kit de ducha termostático empotrado BLOCK SYSTEM

- con cierre y regulación de caudal (3 vías).
- Cuerpo empotrado termostático incluido.
- Rociador de ducha INOX a techo con 2 tipos de chorro. 500x500 mm.
- Barra deslizante con toma de agua a pared. Long 760 mm.
- Ducha móvil anticálcarea.
- Flexo.

IMPORTANTE: Montar un desagüe de >50 l/min.

Ac 299.250.45.AC
NM 299.250.45.NM
BM 299.250.45.BM

Ac 207.253.11.AC

NM 207.253.11.NM

BM 207.253.11.BM



INSTALACIÓN RECOMENDADA

REF. 207.253.11 / 207.253.11.AC / 207.253.11.NM / 207.253.11.BM

Este es un esquema de instalación recomendado para aprovechar al máximo las funciones del grifo.

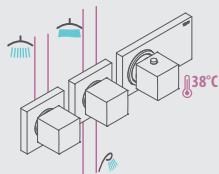

Kit de ducha termostático empotrado BLOCK SYSTEM

- con cierre y regulación de caudal (3 vías).
 - Cuerpo empotrado termostático incluido.
 - Rociador ducha INOX a techo con 2 tipos de chorro. 500x500 mm. (299.954.01).
 - Ducha móvil anticalcárea (202.639.01).
 - Flexo SATIN (91.34.609.15).
- IMPORTANTE: Montar un desagüe de >50 l/min.

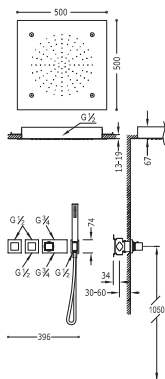

299.250.45 | **Cr | 207.253.12** |

Kit de ducha termostático empotrado BLOCK SYSTEM

- con cierre y regulación de caudal (3 vías).
 - Cuerpo empotrado termostático incluido.
 - Rociador ducha INOX a techo con 2 tipos de chorro. 500x500 mm. (299.954.01).
 - Barra deslizante con toma de agua a pared. Long 760 mm.
 - Ducha móvil anticalcárea (202.639.01).
 - Flexo SATIN (91.34.609.15).
- IMPORTANTE: Montar un desagüe de >50 l/min.

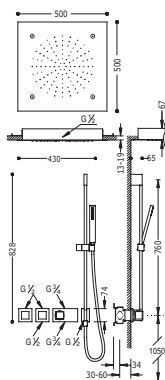

299.250.45 | **Cr | 207.253.13** |



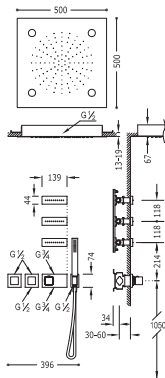

Kit de ducha termostático empotrado BLOCK SYSTEM CROMOTERAPIA

- con cierre y regulación de caudal (3 vías).
- Cuerpo empotrado termostático incluido.
- Rociador ducha INOX a techo 500x500 mm. (299.962.01).
- 3 jets antical.
- Ducha móvil anticalcárea (202.639.01).
- Flexo SATIN (91.34.609.15).

IMPORTANTE: Montar un desagüe de >50 l/min.

Cr 207.254.04

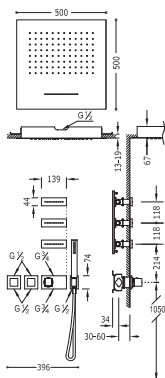

Kit de ducha termostático empotrado BLOCK SYSTEM

- con cierre y regulación de caudal (4 vías).
- Cuerpo empotrado termostático incluido.
- Rociador ducha INOX a techo con 2 tipos de chorro. 500x500 mm. (299.955.01).
- 3 jets antical.
- Ducha móvil anticalcárea (202.639.01).
- Flexo SATIN (91.34.609.15).

IMPORTANTE: Montar un desagüe de >50 l/min.

Cr 207.254.02

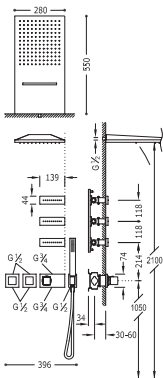

Kit de ducha termostático empotrado BLOCK SYSTEM

- con cierre y regulación de caudal (4 vías).
 - Cuerpo empotrado termostático incluido.
 - Rociador ducha INOX a pared con 2 tipos de chorro. 280x550 mm. (299.903.01).
 - 3 jets antical.
 - Ducha móvil anticalárea (202.639.01).
 - Flexo SATIN (91.34.609.15).
- IMPORTANTE: Montar un desagüe de >50 l/min.

299.250.45 **207.254.01**

INSTALACIÓN RECOMENDADA

REF. 207.254.01

Este es un esquema de instalación recomendado para aprovechar al máximo las funciones del grifo.

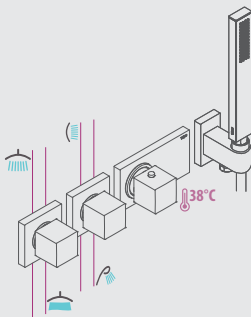

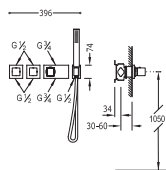
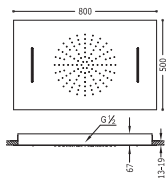

Kit de ducha termostático empotrado BLOCK SYSTEM

- con cierre y regulación de caudal (4 vías).
 - Cuerpo empotrado termostático incluido.
 - Rociador ducha INOX a techo con 2 tipos de chorro. 500x800 mm. (299.966.01).
 - Ducha móvil anticalcárea (202.639.01).
 - Flexo SATIN (91.34.609.15).
- IMPORTANTE: Montar un desague de >50 l/min.

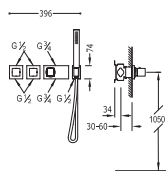
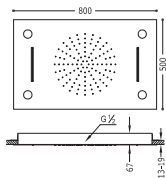

Kit de ducha termostático empotrado BLOCK SYSTEM CROMOTERAPIA

- con cierre y regulación de caudal (4 vías).
 - Cuerpo empotrado termostático incluido.
 - Rociador ducha INOX a techo con 2 tipos de chorro. 500x800 mm. (299.965.01).
 - Ducha móvil anticalcárea (202.639.01).
 - Flexo SATIN (91.34.609.15).
- IMPORTANTE: Montar un desague de >50 l/min.



Kit de bañera termostático empotrado BLOCK SYSTEM

- con cierre y regulación de caudal (3 vías).
- Cuerpo empotrado termostático incluido.
- Rociador ducha INOX a pared 210x550 mm. (299.903.02).
- Caño cascada INOX (299.903.04).
- Ducha móvil anticalcárea (202.639.01).
- Flexo SATIN (91.34.609.15).

IMPORTANTE: Montar un desagüe de >50 l/min.

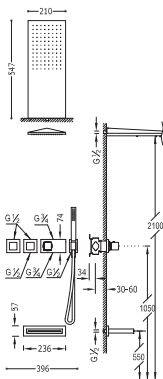

Cr | 207.253.05

Kit de bañera termostático empotrado BLOCK SYSTEM

- con cierre y regulación de caudal (3 vías).
- Cuerpo empotrado termostático incluido.
- Rociador ducha INOX a pared 210x550 mm.
- Caño cascada INOX.
- Ducha móvil anticalcárea.
- Flexo

IMPORTANTE: Montar un desagüe de >50 l/min.

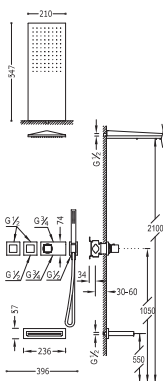

AC | 207.253.05.AC

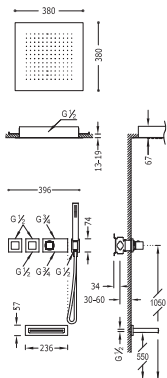

Kit de bañera termostático empotrado BLOCK SYSTEM

- con cierre y regulación de caudal (3 vías).
- Cuerpo empotrado termostático incluido.
- Rociador ducha INOX a techo 380x380 mm. (1.34.944).
- Caño cascada INOX (299.903.04).
- Ducha móvil anticalcárea (202.639.01).
- Flexo SATIN (91.34.609.15).

IMPORTANTE: Montar un desagüe de >50 l/min.







 299.250.45 **207.253.06**

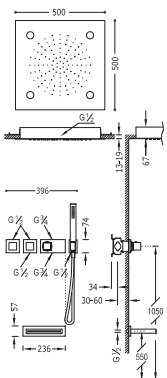

Kit de bañera termostático empotrado BLOCK SYSTEM CROMOTERAPIA

- con cierre y regulación de caudal (3 vías).
- Cuerpo empotrado termostático incluido.
- Rociador ducha a techo 500x500 mm. (299.962.01).
- Caño cascada INOX (299.903.04).
- Ducha móvil anticalcárea (202.639.01).
- Flexo SATIN (91.34.609.15).

IMPORTANTE: Montar un desagüe de >50 l/min.







 299.250.45 **207.253.07**

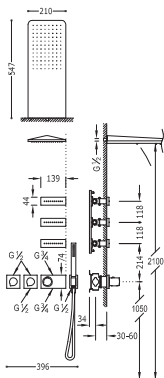

Kit de ducha termostático empotrado BLOCK SYSTEM

- con cierre y regulación de caudal (3 vías).
 - Cuerpo empotrado termostático incluido.
 - Rociador ducha INOX a pared 210x550 mm. (299.903.07).
 - 3 jets antical.
 - Ducha móvil anticalcárea (034.116.01).
 - Flexo SATIN (91.34.609.15).
- IMPORTANTE: Montar un desagüe de >50 l/min.



Cr | 207.353.01

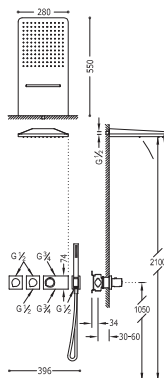

Kit de ducha termostático empotrado BLOCK SYSTEM

- con cierre y regulación de caudal (3 vías).
 - Cuerpo empotrado termostático incluido.
 - Rociador ducha INOX a pared con 2 tipos de chorro. 280x550 mm (299.903.08).
 - Ducha móvil anticalcárea (034.116.01).
 - Flexo SATIN (91.34.609.15).
- IMPORTANTE: Montar un desagüe de >50 l/min.



Cr | 207.353.02

BLOCK SYSTEM



N

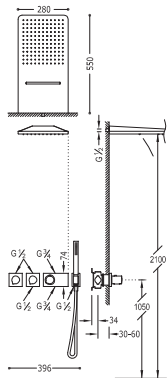

Kit de ducha termostático empotrado BLOCK SYSTEM

- con cierre y regulación de caudal (3 vías).
- Cuerpo empotrado termostático incluido.
- Rociador ducha INOX a pared con 2 tipos de chorro. 280x550 mm.
- Ducha móvil anticalcárea.
- Flexo.

IMPORTANTE: Montar un desagüe de >50 l/min.

Al: 299.250.45.AC
 NM: 299.250.45.NM
 BM: 299.250.45.BM

AC	207.353.02.AC
NM	207.353.02.NM
BM	207.353.02.BM

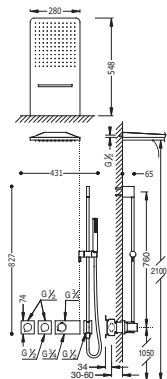

Kit de ducha termostático empotrado BLOCK SYSTEM

- con cierre y regulación de caudal (3 vías).
- Cuerpo empotrado termostático incluido.
- Rociador ducha INOX a pared con 2 tipos de chorro. 280x550 mm (299.903.08).
- Barra deslizante con toma de agua a pared. Long 760 mm.
- Ducha móvil anticalcárea (034.116.01).
- Flexo SATIN (91.34.609.15).

IMPORTANTE: Montar un desagüe de >50 l/min.

299.195.03

Cr 207.353.09



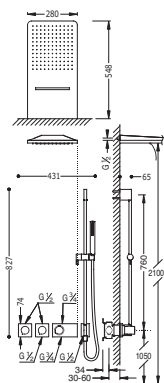

Kit de ducha termostático empotrado BLOCK SYSTEM

- con cierre y regulación de caudal (3 vías).
- Cuerpo empotrado termostático incluido.
- Rociador ducha INOX a pared con 2 tipos de chorro. 280x550 mm.
- Barra deslizante con toma de agua a pared. Long 760 mm.
- Ducha móvil anticálarea.
- Flexo.

IMPORTANTE: Montar un desagüe de >50 l/min.

Ac 299.250.45.AC
NM 299.250.45.NM
BM 299.250.45.BM

AC | 207.353.09.AC

NM | 207.353.09.NM

BM | 207.353.09.BM

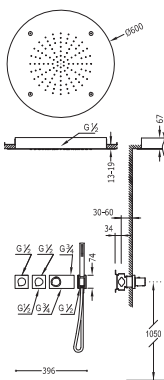

Kit de ducha termostático empotrado BLOCK SYSTEM

- con cierre y regulación de caudal (3 vías).
- Cuerpo empotrado termostático incluido.
- Rociador ducha INOX a techo con 2 tipos de chorro. Ø 600 mm.
- (299.956.01).
- Ducha móvil anticálarea (034.116.01).
- Flexo SATIN (91.34.609.15).

IMPORTANTE: Montar un desagüe de >50 l/min.

299.195.03
Cr | 207.353.10



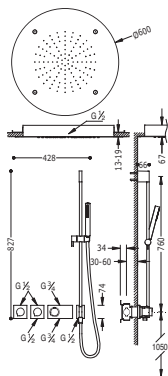

Kit de ducha termostático empotrado BLOCK SYSTEM

- con cierre y regulación de caudal (3 vías).
- Cuerpo empotrado termostático incluido.
- Rociador ducha INOX a techo con 2 tipos de chorro. Ø 600 mm. (299.956.01).
- Barra deslizante con toma de agua a pared. Long 760 mm.
- Ducha móvil anticalcárea (034.116.01).
- Flexo SATIN (91.34.609.15).

IMPORTANTE: Montar un desagüe de >50 l/min.



Cr 207.353.11

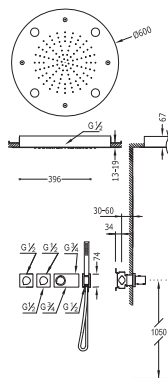

Kit de ducha termostático empotrado BLOCK SYSTEM CROMOTERAPIA

- con cierre y regulación de caudal (3 vías).
- Cuerpo empotrado termostático incluido.
- Rociador ducha INOX a techo con 2 tipos de chorro. Ø 600 mm. (299.958.01).
- Ducha móvil anticalcárea (034.116.01).
- Flexo SATIN (91.34.609.15).

IMPORTANTE: Montar un desagüe de >50 l/min.



Cr 207.353.12

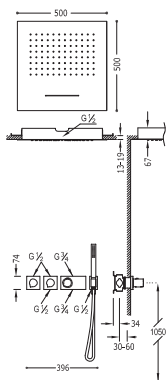

Kit de ducha termostático empotrado BLOCK SYSTEM

- con cierre y regulación de caudal (3 vías).
- Cuerpo empotrado termostático incluido.
- Rociador ducha INOX a techo con 2 tipos de chorro. 500x500 mm. (299.955.01).
- Ducha móvil anticalcárea (034.116.01).
- Flexo SATIN (91.34.609.15).

IMPORTANTE: Montar un desagüe de >50 l/min.



Cr | 207.353.03

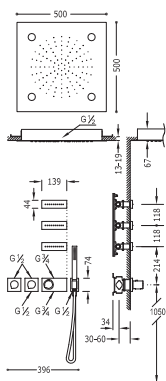

Kit de ducha termostático empotrado BLOCK SYSTEM CROMOTERAPIA

- con cierre y regulación de caudal (3 vías).
- Cuerpo empotrado termostático incluido.
- Rociador ducha INOX a techo 500x500 mm. (299.962.01).
- 3 jets antical.
- Ducha móvil anticalcárea (034.116.01).
- Flexo SATIN (91.34.609.15).

IMPORTANTE: Montar un desagüe de >50 l/min.



Cr | 207.353.04

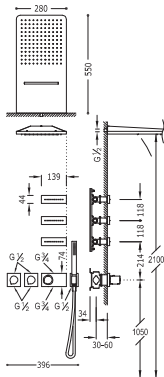

Kit de ducha termostático empotrado BLOCK SYSTEM

- con cierre y regulación de caudal (4 vías).
- Cuerpo empotrado termostático incluido.
- Rociador ducha INOX a pared con 2 tipos de chorro. 280x550 mm (299.903.08).
- 3 jets antical.
- Ducha móvil anticalcárea (034.116.01).
- Flexo SATIN (91.34.609.15).

IMPORTANTE: Montar un desagüe de >50 l/min.



299.195.03



207.354.01

Cr

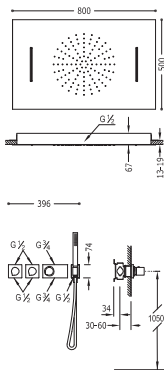

Kit de ducha termostático empotrado BLOCK SYSTEM

- con cierre y regulación de caudal (4 vías).
- Cuerpo empotrado termostático incluido.
- Rociador ducha INOX a techo con 2 tipos de chorro. 500x800 mm. (299.966.01).
- Ducha móvil anticalcárea (034.116.01).
- Flexo SATIN (91.34.609.15).

IMPORTANTE: Montar un desagüe de >50 l/min.



299.195.03



207.354.03

Cr



Kit de ducha termostático empotrado BLOCK SYSTEM CROMOTERAPIA

- con cierre y regulación de caudal (4 vías).
 - Cuerpo empotrado termostático incluido.
 - Rociador ducha INOX a techo con 2 tipos de chorro. 500x800 mm. (299.965.01).
 - Ducha móvil anticalcárea (034.116.01).
 - Flexo SATIN (91.34.609.15).
- IMPORTANTE: Montar un desagüe de >50 l/min.

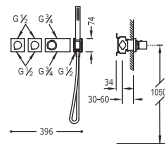
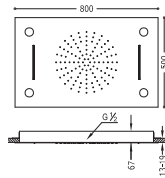

Cr | 207.354.04

INSTALACIÓN RECOMENDADA

REF. 207.354.04

Este es un esquema de instalación recomendado para aprovechar al máximo las funciones del grifo.

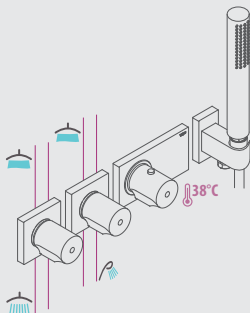

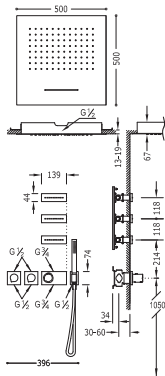

Kit de ducha termostático empotrado BLOCK SYSTEM

- con cierre y regulación de caudal (4 vías).
- Cuerpo empotrado termostático incluido.
- Rociador ducha INOX a techo con 2 tipos de chorro (299.955.01).
- 3 jets antical.
- Ducha móvil anticalárea (034.116.01).
- Flexo SATIN (91.34.609.15).

IMPORTANTE: Montar un desagüe de >50 l/min.

299.195.03
Cr 207.354.02

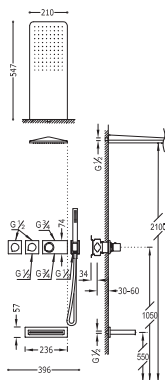

Kit de bañera termostático empotrado BLOCK SYSTEM

- con cierre y regulación de caudal (3 vías).
- Cuerpo empotrado termostático incluido.
- Rociador ducha INOX a pared 210x550 mm. (299.903.07).
- Caño cascada INOX (299.903.04).
- Ducha móvil anticalárea (034.116.01).
- Flexo SATIN (91.34.609.15).

IMPORTANTE: Montar un desagüe de >50 l/min.

299.195.03
Cr 207.353.05

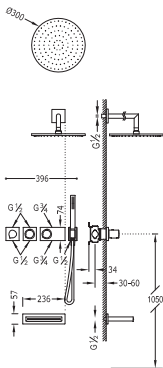

Kit de bañera termostático empotrado BLOCK SYSTEM

- con cierre y regulación de caudal (3 vías).
 - Cuerpo empotrado termostático incluido.
 - Ducha fija \varnothing 300 mm. con rúcula. Material Latón.
 - Caño cascada INOX.
 - Ducha móvil anticálcarea.
 - Flexo.
- IMPORTANTE: Montar un desagüe de >50 l/min.

Cr	299.195.03	
Ac	299.195.03.AC	
Cr	207.353.08	
Ac	207.353.08.AC	

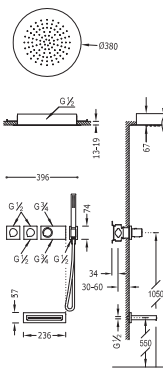

Kit de bañera termostático empotrado BLOCK SYSTEM

- con cierre y regulación de caudal (3 vías).
 - Cuerpo empotrado termostático incluido.
 - Rociador ducha INOX a techo \varnothing 380 mm. (1.34.940).
 - Caño cascada INOX (299.903.04).
 - Ducha móvil anticálcarea (034.116.01).
 - Flexo SATIN (91.34.609.15).
- IMPORTANTE: Montar un desagüe de >50 l/min.

Cr	299.195.03	
Ac	299.195.03.AC	
Cr	207.353.06	





Kit de bañera termostático empotrado BLOCK SYSTEM CROMOTERAPIA

- con cierre y regulación de caudal (3 vías).
- Cuerpo empotrado termostático incluido.
- Rociador ducha INOX a techo 500x500 mm. (299.962.01).
- Caño cascada INOX (299.903.04).
- Ducha móvil anticalcárea (034.116.01).
- Flexo SATIN (91.34.609.15).

IMPORTANTE: Montar un desagüe de >50 l/min.

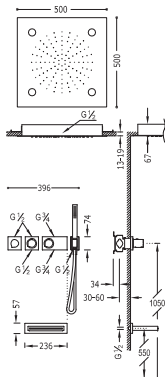

INSTALACIÓN RECOMENDADA

REF. 207.353.07

Este es un esquema de instalación recomendado para aprovechar al máximo las funciones del grifo.

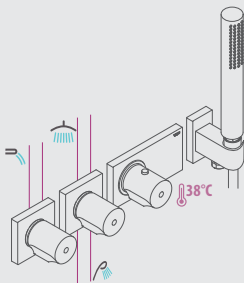





Ref:

PARA 1-2 VÍAS

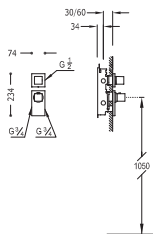

Termostática empotrar BLOCK SYSTEM

con cierre y regulación de caudal.

· Cuerpo empotrado termostático incluido.

* NOTA: Es obligatorio añadir en el pedido un rociador, ducha de mano, jets o un caño bañera, dependiendo del tipo de instalación.



299.250.45
1 vía

Cr ***206.251.99**

299.250.45
2 vías

Cr ***206.252.99**

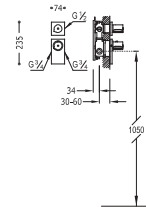

Termostática empotrar BLOCK SYSTEM

con cierre y regulación de caudal.

· Cuerpo empotrado termostático incluido.

* NOTA: Es obligatorio añadir en el pedido un rociador, ducha de mano, jets o un caño bañera, dependiendo del tipo de instalación.



299.195.03
1 vía

Cr ***206.351.99**

299.195.03
2 vías

Cr ***206.352.99**

Termostática empotrar BLOCK SYSTEM

con cierre y regulación de caudal.

- Cuerpo empotrado termostático incluido.

* NOTA: Es obligatorio añadir en el pedido un rociador, ducha de mano, jets o un caño bañera, dependiendo del tipo de instalación.

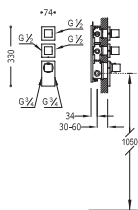

Cr | *206.253.99 |



Cr | *206.254.99 |



Termostática empotrar BLOCK SYSTEM

con cierre y regulación de caudal.

- Cuerpo empotrado termostático incluido.

* NOTA: Es obligatorio añadir en el pedido un rociador, ducha de mano, jets o un caño bañera, dependiendo del tipo de instalación.

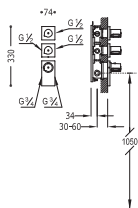

Cr | *206.353.99 |



Cr | *206.354.99 |



Soporte para ducha BLOCK SYSTEM

con toma de agua a pared regulable en profundidad, válvula antirretorno, cuerpo empotrado incluido y perfil de instalación.

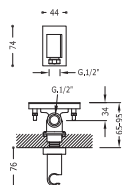

Cr | 207.182.02 |

PARA 1-2 VÍAS

Ref:

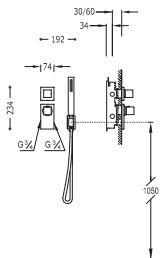

Termostática empotrar BLOCK SYSTEM

- con cierre y regulación de caudal.
 - Cuerpo empotrado termostático incluido.
 - Ducha móvil anticalcárea (202.639.01).
 - Flexo SATIN (91.34.609.15).
- * NOTA: Es obligatorio añadir en el pedido un rociador, jets o un caño bañera, dependiendo del tipo de instalación.

	299.250.45	DEJABADA	1 vía
Cr	*206.251.91		



	299.250.45	DEJABADA	2 vías
Cr	*206.251.91		

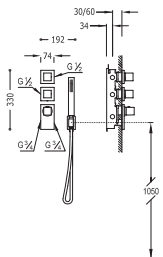

Termostática empotrar BLOCK SYSTEM

- con cierre y regulación de caudal.
 - Cuerpo empotrado termostático incluido.
 - Ducha móvil anticalcárea (202.639.01).
 - Flexo SATIN (91.34.609.15).
- * NOTA: Es obligatorio añadir en el pedido un rociador, jets o un caño bañera, dependiendo del tipo de instalación.

	299.250.45	DEJABADA	3 vías
Cr	*206.253.91		



	299.250.45	DEJABADA	4 vías
Cr	*206.254.91		



Termostática empotrar BLOCK SYSTEM

- con cierre y regulación de caudal.
- Cuerpo empotrado termostático incluido
- Ducha móvil anticálcarea (034.116.01).
- Flexo SATIN (91.34.609.15).

* NOTA: Es obligatorio añadir en el pedido un rociador, jets o un caño bañera, dependiendo del tipo de instalación.

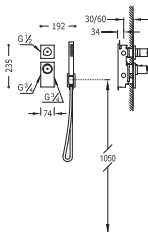

299.195.03 1 vía

Cr | *206.351.91 |

299.195.03 2 vías

Cr | *206.352.91 |



Termostática empotrar BLOCK SYSTEM

- con cierre y regulación de caudal.
- Cuerpo empotrado termostático incluido
- Ducha móvil anticálcarea (034.116.01).
- Flexo SATIN (91.34.609.15).

* NOTA: Es obligatorio añadir en el pedido un rociador, jets o un caño bañera, dependiendo del tipo de instalación.

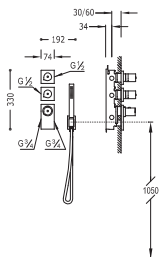

299.195.03 3 vías

Cr | *206.353.91 |

299.195.03 4 vías

Cr | *206.354.91 |



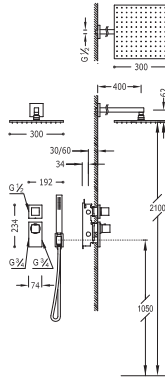

Kit de ducha termostático empotrado BLOCK SYSTEM

- con cierre y regulación de caudal (2 vías).
- Cuerpo empotrado termostático incluido.
- Ducha fija 300x300 mm. con rótula (1.34.138.30). Material Latón.
- Ducha móvil anticalcárea (202.639.01).
- Flexo SATIN (91.34.609.15).



N

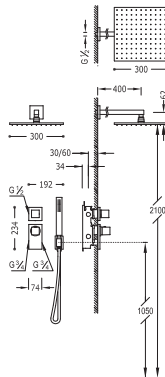

Kit de ducha termostático empotrado BLOCK SYSTEM

- con cierre y regulación de caudal (2 vías).
- Cuerpo empotrado termostático incluido.
- Ducha fija 300x300 mm. con rótula. Material Latón.
- Ducha móvil anticalcárea.
- Flexo.



	Ac 299.250.45.AC
	NM 299.250.45.NM
	BM 299.250.45.BM
Ac	206.252.01.AC
NM	206.252.01.NM
BM	206.252.01.BM

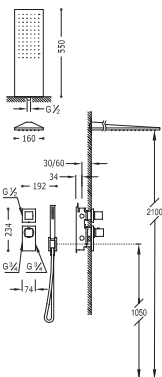

Kit de ducha termostático empotrado BLOCK SYSTEM

- con cierre y regulación de caudal (2 vías).
- Cuerpo empotrado termostático incluido.
- Rociador ducha INOX a pared 160x550 mm. (299.903.03).
- Ducha móvil anticalcárea (202.639.01).
- Flexo SATIN (91.34.609.15).



299.250.05

Cr | **206.252.02** |

N

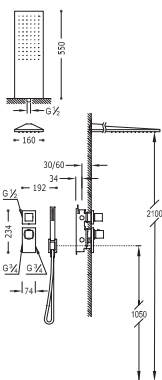

Kit de ducha termostático empotrado BLOCK SYSTEM

- con cierre y regulación de caudal (2 vías).
- Cuerpo empotrado termostático incluido.
- Rociador ducha INOX a pared 160x550 mm.
- Ducha móvil anticalcárea.
- Flexo.

Ac 299.250.05.AC
NM 299.250.05.NM
BM 299.250.05.BM

Ac | **206.252.02.AC** |

NM | **206.252.02.NM** |

BM | **206.252.02.BM** |



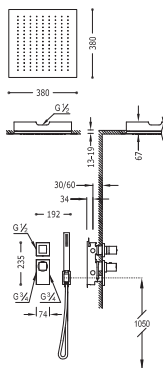

Kit de ducha termostático empotrado BLOCK SYSTEM

- con cierre y regulación de caudal (2 vías).
- Cuerpo empotrado termostático incluido.
- Rociador ducha INOX a techo 380x380 mm. (1.34.944).
- Ducha móvil anticalcárea (202.639.01).
- Flexo SATIN (91.34.609.15).

Cr **206.252.04**

N

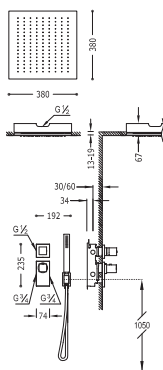

Kit de ducha termostático empotrado BLOCK SYSTEM

- con cierre y regulación de caudal (2 vías).
- Cuerpo empotrado termostático incluido.
- Rociador ducha INOX a techo 380x380 mm.
- Ducha móvil anticalcárea.
- Flexo.

Ac	299.250.45.AC
NM	299.250.45.NM
BM	299.250.45.BM
Ac	206.252.04.AC
NM	206.252.04.NM
BM	206.252.04.BM

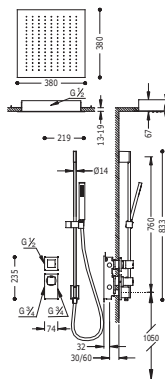

Kit de ducha termostático empotrado BLOCK SYSTEM

- con cierre y regulación de caudal (2 vías).
- Cuerpo empotrado termostático incluido.
- Rociador ducha INOX a techo 380x380 mm. (1.34.944).
- Barra deslizante con toma de agua a pared. Long 760 mm
- Ducha móvil anticalcárea (202.639.01).
- Flexo SATIN (91.34.609.15).



Cr | 206.252.03



N

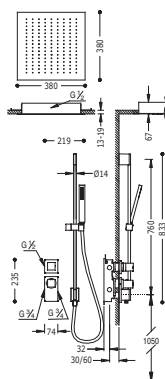

Kit de ducha termostático empotrado BLOCK SYSTEM

- con cierre y regulación de caudal (2 vías).
- Cuerpo empotrado termostático incluido.
- Rociador ducha INOX a techo 380x380 mm.
- Barra deslizante con toma de agua a pared. Long 760 mm.
- Ducha móvil anticalcárea.
- Flexo.

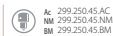

Ac 299.250.05.AC
NM 299.250.05.NM
BM 299.250.05.BM

Ac 206.252.03.AC

NM 206.252.03.NM

BM 206.252.03.BM



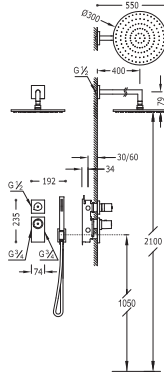

Kit de ducha termostático empotrado BLOCK SYSTEM

- con cierre y regulación de caudal (2 vías).
- Cuerpo empotrado termostático incluido.
- Ducha fija Ø 300 mm. con rótula. Material Latón (1.34.137.30).
- Ducha móvil anticalcárea (034.116.01).
- Flexo SATIN (91.34.609.15).



N

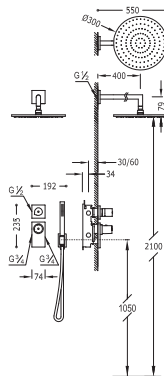

Kit de ducha termostático empotrado BLOCK SYSTEM

- con cierre y regulación de caudal (2 vías).
- Cuerpo empotrado termostático incluido.
- Ducha fija Ø 300 mm. con rótula. Material Latón.
- Ducha móvil anticalcárea.
- Flexo.



Ac	299.195.03.AC
NM	299.195.03.NM
BM	299.195.03.BM
Ac	206.352.01.AC
NM	206.352.01.NM
BM	206.352.01.BM

Kit de ducha termostático empotrado BLOCK SYSTEM

- con cierre y regulación de caudal (2 vías).
- Cuerpo empotrado termostático incluido.
- Rociador ducha INOX a pared 160x550 mm. (299.903.06).
- Ducha móvil anticalcárea (034.116.01).
- Flexo SATIN (91.34.609.15).

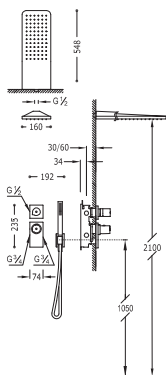

299.195.03 | 206.352.02

Cr

N

Kit de ducha termostático empotrado BLOCK SYSTEM

- con cierre y regulación de caudal (2 vías).
- Cuerpo empotrado termostático incluido.
- Rociador ducha INOX a pared 160x550 mm.
- Ducha móvil anticalcárea.
- Flexo.

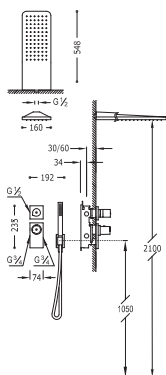

Ac 299.195.03.AC
Nm 299.195.03.NM
Bm 299.195.03.BM

Ac 206.352.02.AC

Nm 206.352.02.NM

Bm 206.352.02.BM



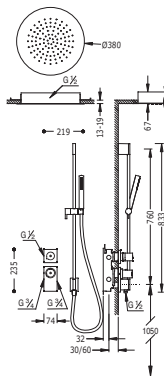

Kit de ducha termostático empotrado BLOCK SYSTEM

- con cierre y regulación de caudal (2 vías).
- Cuerpo empotrado termostático incluido.
- Rociador ducha INOX a techo Ø 380 mm. (1.34.940).
- Barra deslizante con toma de agua a pared. Long 760 mm.
- Ducha móvil anticalcárea (034.116.01).
- Flexo SATIN (91.34.609.15).



209.195.03

REINAVIA

Cr 206.352.03

INSTALACIÓN RECOMENDADA

REF. 206.352.03 / 206.352.03.AC / 206.352.03.NM / 206.352.03.BM

Este es un esquema de instalación recomendado para aprovechar al máximo las funciones del grifo.

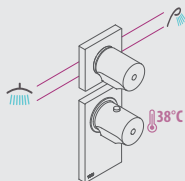

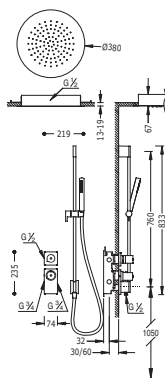

Kit de ducha termostático empotrado BLOCK SYSTEM

- con cierre y regulación de caudal (2 vías).
- Cuerpo empotrado termostático incluido.
- Rociador ducha INOX a techo Ø 380 mm.
- Barra deslizante con toma de agua a pared. Long 760 mm.
- Ducha móvil anticalcárea.
- Flexo.

AC	206.352.03.AC
NM	206.352.03.NM
BM	206.352.03.BM



Kit de ducha termostático empotrado BLOCK SYSTEM

- con cierre y regulación de caudal (2 vías).
- Cuerpo empotrado termostático incluido.
- Rociador ducha INOX a techo Ø 380 mm. (1.34.940).
- Ducha móvil anticalcárea (034.116.01).
- Flexo SATIN (91.34.609.15).

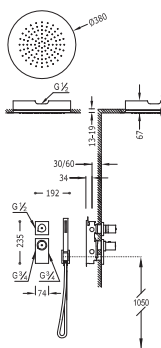

Cr	206.352.04
----	------------



BLOCK SYSTEM

N



Kit de ducha termostático empotrado BLOCK SYSTEM

- con cierre y regulación de caudal (2 vías).
- Cuerpo empotrado termostático incluido.
- Rociador ducha INOX a techo Ø 380 mm.
- Ducha móvil anticalcárea.
- Flexo.

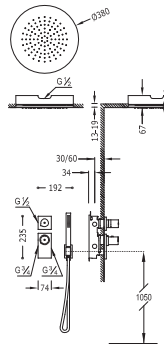

	Al: 299.195.03.AC NM: 299.195.03.NM BM: 299.195.03.BM
AC	206.352.04.AC
NM	206.352.04.NM
BM	206.352.04.BM



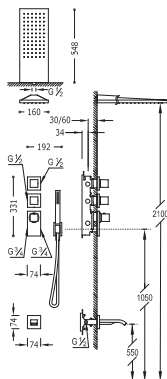

Kit de bañera termostático empotrado BLOCK SYSTEM

- con cierre y regulación de caudal (3 vías).
- Cuerpo empotrado termostático incluido.
- Rociador ducha INOX a pared 160x550 mm. (299.903.03).
- Caño cascada.
- Ducha móvil anticalcárea (202.639.01).
- Flexo SATIN (91.34.609.15).



299.250.45 | 299.250.45

Cr | 206.253.01

BLOCK SYSTEM

N

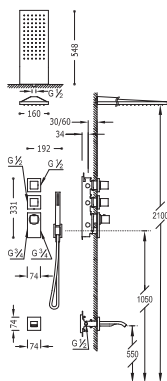

Kit de bañera termostático empotrado BLOCK SYSTEM

- con cierre y regulación de caudal (3 vías).
- Cuerpo empotrado termostático incluido.
- Rociador ducha INOX a pared 160x550 mm.
- Caño cascada.
- Ducha móvil anticalcárea.
- Flexo.

Ac 299.250.45.AC
Nm 299.250.45.NM
Bm 299.250.45.BM

Ac | 206.253.01.AC

NM | 206.253.01.NM

BM | 206.253.01.BM



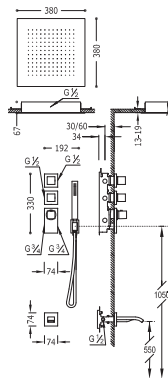

Kit de bañera termostático empotrado BLOCK SYSTEM

- con cierre y regulación de caudal (3 vías).
- Cuerpo empotrado termostático incluido.
- Rociador ducha INOX a techo 380x380 mm. (1.34.944).
- Caño cascada.
- Ducha móvil anticalcárea (202.639.01).
- Flexo SATIN (91.34.609.15).



N

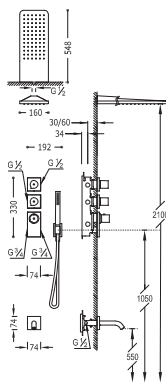

Kit de bañera termostático empotrado BLOCK SYSTEM

- con cierre y regulación de caudal (3 vías).
- Cuerpo empotrado termostático incluido.
- Rociador ducha INOX a pared 160x550 mm.
- Caño bañera.
- Ducha móvil anticalcárea.
- Flexo.



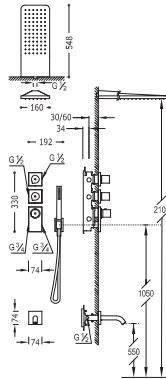

Kit de bañera termostático empotrado BLOCK SYSTEM

- con cierre y regulación de caudal (3 vías).
- Cuerpo empotrado termostático incluido.
- Rociador ducha INOX a pared 160x550 mm. (299.903.06).
- Caño bañera.
- Ducha móvil anticalcárea (034.116.01).
- Flexo SATIN (91.34.609.15).



299.195.03

Cr | 206.353.01

INSTALACIÓN RECOMENDADA

REF. 206.353.01 / 206.353.01.AC / 206.353.01.NM / 206.353.01.BM

Este es un esquema de instalación recomendado para aprovechar al máximo las funciones del grifo.

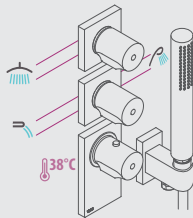

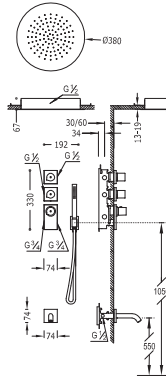

Kit de bañera termostático empotrado BLOCK SYSTEM

- con cierre y regulación de caudal (3 vías).
- Cuerpo empotrado termostático incluido.
- Rociador ducha INOX a techo Ø 380 mm. (1.34.940).
- Caño bañera.
- Ducha móvil anticalcárea (034.116.01).
- Flexo SATIN (91.34.609.15).



N

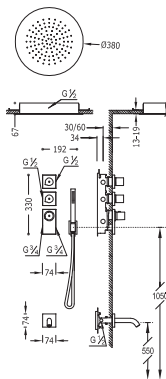

Kit de bañera termostático empotrado BLOCK SYSTEM

- con cierre y regulación de caudal (3 vías).
- Cuerpo empotrado termostático incluido.
- Rociador ducha INOX a techo Ø 380 mm.
- Caño bañera.
- Ducha móvil anticalcárea.
- Flexo.



Ac	299.195.03.AC
NM	299.195.03.NM
BM	299.195.03.BM
Ac	206.353.02.AC
NM	206.353.02.NM
BM	206.353.02.BM





EL CONTROL DE LA DUCHA EN UN SOLO TOQUE

Un termostato electrónico para disfrutar de la ducha sin preocupaciones. Gracias a su panel digital táctil puede programar la temperatura y el caudal de manera fácil e intuitiva para crear una experiencia única y personal.

Tecnología y diseño fusionados para una nueva manera de vivir la ducha.

LA DUCHA TÁCTIL

Showers technology ofrece una amplia variedad de conjuntos termostáticos electrónicos de 2, 3 o 4 vías. Según las vías necesarias, el **control digital del conjunto termostático** está adaptado para facilitar el accionamiento de cada salida del agua de una forma más intuitiva.



La temperatura se encuentra en 38°C cuando se abre inicialmente. Su límite es 46°C como máximo. El nivel de temperatura seleccionada se indica numéricamente y en escala de colores.

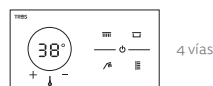
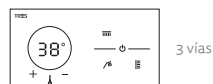
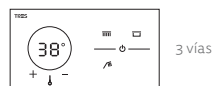
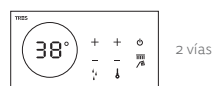

CENTRALITA TERMOSTÁTICA ELECTRÓNICA

La mínima instalación que necesitan estos productos satisfacen al instalador por su fácil y rápido montaje en casos como reformas o cambios de bañeras por platos de ducha, debido a la eliminación de escombros, la supresión d e ruidos molestos para los vecinos, problemas comunitarios o de permisos...

Tan sólo habrá que inutilizar la instalación antigua y colocar los nuevos azulejos encima de los existentes mediante nuevos productos que garantizan una perfecta adherencia, como las pinturas o pastas de agarre.

2 vías >

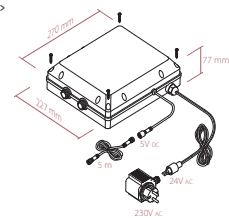

3/4 vías >

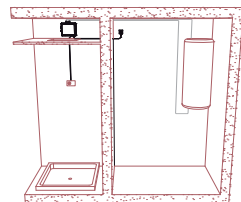
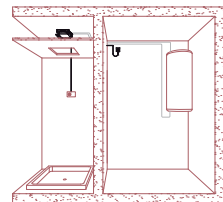
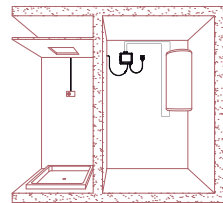
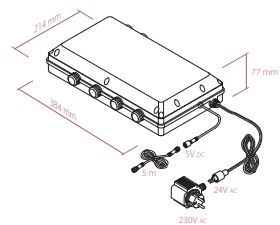



Ref:

PARA 2 VIAS

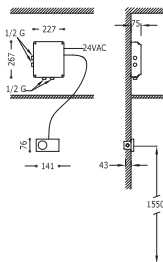

Control termostático electrónico empotrado SHOWER TECHNOLOGY

Control electrónico incluido.
 Centralita termostática electrónica incluida (2 vías).
 * NOTA: Es obligatorio añadir en el pedido un rociador, ducha de mano, jets o un caño bañera, dependiendo del tipo de instalación.

BI	092.862.99	
Ng	092.882.99	N

PARA 3 VIAS

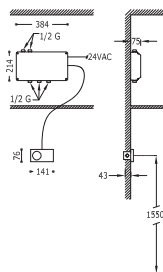

Control termostático electrónico empotrado SHOWER TECHNOLOGY

Control electrónico incluido.
 Centralita termostática electrónica incluida (3 vías).
 * NOTA: Es obligatorio añadir en el pedido un rociador, ducha de mano, jets o un caño bañera, dependiendo del tipo de instalación.

BI	092.863.99	
Ng	092.883.99	N

PARA 3 VIAS

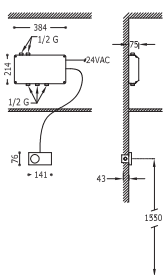

Control termostático electrónico empotrado SHOWER TECHNOLOGY

- Control electrónico incluido.
- Centralita termostática electrónica incluida (3 vías).
- * NOTA: Es obligatorio añadir en el pedido un rociador, ducha de mano, jets o un caño bañera, dependiendo del tipo de instalación.

Bl	092.863.98	
Ng	092.883.98	N

PARA 4 VIAS

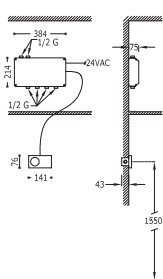

Control termostático electrónico empotrado SHOWER TECHNOLOGY

- Control electrónico incluido.
- Centralita termostática electrónica incluida (4 vías).
- * NOTA: Es obligatorio añadir en el pedido un rociador, ducha de mano, jets o un caño bañera, dependiendo del tipo de instalación.

Bl	092.864.99	
Ng	092.884.99	N

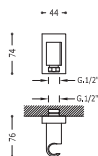

Soporte para ducha
con toma de agua a pared y válvula antirretorno.

Cr	207.182.01	
----	------------	--

PARA 2 VÍAS

Ref.:

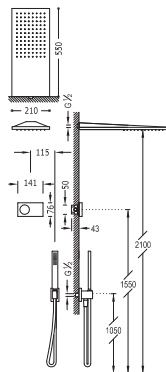

Kit electrónico de ducha termostático empotrado
SHOWER TECHNOLOGY

- Control electrónico incluido.
- Centralita termostática electrónica incluida (2 vías).
- Rociador ducha INOX a pared 210x550 mm. (299.903.02).
- Soporte con toma pared (207.182.01).
- Ducha móvil anticalcárea (202.639.01).
- Flexo SATIN (91.34.609.15).

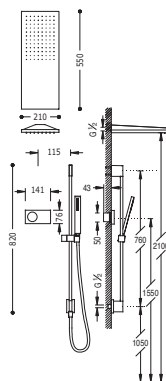

Kit electrónico de ducha termostático empotrado
SHOWER TECHNOLOGY

- Control electrónico incluido.
- Centralita termostática electrónica incluida (2 vías).
- Rociador ducha INOX a pared 210x550 mm. (299.903.02).
- Barra deslizante con toma de agua a pared. Long 760 mm. (034.932.99).
- Ducha móvil anticalcárea (202.639.01).
- Flexo SATIN (91.34.609.15).



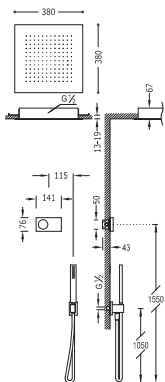

**Kit electrónico de ducha termostático empotrado
SHOWER TECHNOLOGY**

- Control electrónico incluido.
- Centralita termostática electrónica incluida (2 vías).
- Rociador ducha INOX a techo 380x380 mm. (1.34.944).
- Soporte con toma pared (207.182.01).
- Ducha móvil anticalcárea (202.639.01).
- Flexo SATIN (91.34.609.15).

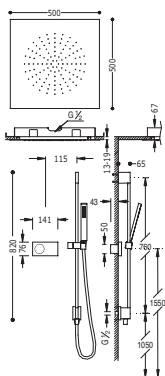

**Kit electrónico de ducha termostático empotrado
SHOWER TECHNOLOGY**

- Control electrónico incluido.
- Centralita termostática electrónica incluida (2 vías).
- Rociador ducha INOX a techo 500x500 mm. (299.953.02).
- Barra deslizante con toma de agua a pared. Long 760 mm. (034.932.99).
- Ducha móvil anticalcárea (202.639.01).
- Flexo SATIN (91.34.609.15).



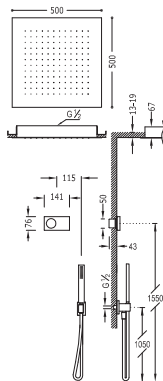

Kit electrónico de ducha termostático empotrado SHOWER TECHNOLOGY

- Control electrónico incluido.
- Centralita termostática electrónica incluida (2 vías).
- Rociador ducha INOX a techo 500x500 mm. (1.34.951).
- Soporte con toma pared (207.182.01).
- Ducha móvil anticalcárea (202.639.01).
- Flexo SATIN (91.34.609.15).

Cr 092.865.61

Cr 092.885.61

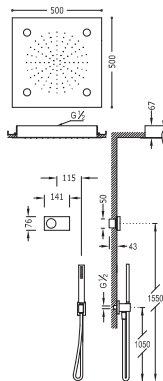

Kit electrónico de ducha termostático empotrado SHOWER TECHNOLOGY con CROMOTERAPIA

- Control electrónico incluido.
- Centralita termostática electrónica incluida (2 vías).
- Rociador ducha INOX a techo 500x500 mm. (299.962.01).
- Soporte con toma pared (207.182.01).
- Ducha móvil anticalcárea (202.639.01).
- Flexo SATIN (91.34.609.15).

Cr 092.865.62

Cr 092.885.62



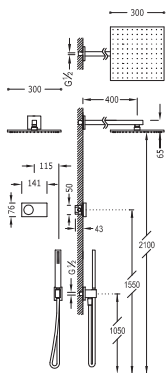

Kit electrónico de ducha termostático empotrado
SHOWER TECHNOLOGY

- Control electrónico incluido.
- Centralita termostática electrónica incluida (2 vías).
- Ducha fija 300x300 mm. con rótula. Material Latón (1.34.138.30).
- Soporte con toma pared (207.182.01).
- Ducha móvil anticalcárea (202.639.01).
- Flexo SATIN (91.34.609.15).

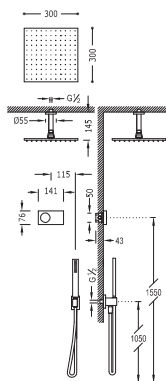

Kit electrónico de ducha termostático empotrado
SHOWER TECHNOLOGY

- Control electrónico incluido.
- Centralita termostática electrónica incluida (2 vías).
- Ducha fija 300x300 mm. con rótula. Material Latón (1.34.138.30).
- Soporte con toma pared (207.182.01).
- Ducha móvil anticalcárea (202.639.01).
- Flexo SATIN (91.34.609.15).



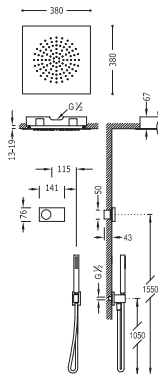

Kit electrónico de ducha termostático empotrado SHOWER TECHNOLOGY

- Control electrónico incluido.
- Centralita termostática electrónica incluida (2 vías).
- Rociador ducha INOX a techo 380x380 mm. (299.953.01).
- Soporte con toma pared (207.182.01).
- Ducha móvil anticalcárea (202.639.01).
- Flexo SATIN (91.34.609.15).

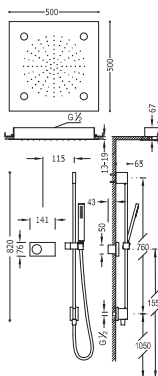

Kit electrónico de ducha termostático empotrado SHOWER TECHNOLOGY con CROMOTERAPIA

- Control electrónico incluido.
- Centralita termostática electrónica incluida (2 vías).
- Rociador ducha INOX a techo 500x500 mm. (299.962.01).
- Barra deslizante con toma de agua a pared. Long 760 mm. (034.932.99).
- Ducha móvil anticalcárea (202.639.01).
- Flexo SATIN (91.34.609.15).



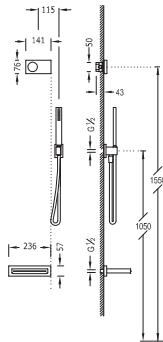

Kit electrónico de bañera termostático empotrado
SHOWER TECHNOLOGY

- Control electrónico incluido.
- Centralita termostática electrónica incluida (2 vías).
- Caño cascada INOX (299.903.04).
- Soporte con toma pared (207.182.01).
- Ducha móvil anticalcárea (202.639.01).
- Flexo SATIN (91.34.609.15).



Cr | 092.865.53 |



Cr | 092.885.53 |



Kit electrónico de bañera termostático empotrado
SHOWER TECHNOLOGY

- Control electrónico incluido.
- Centralita termostática electrónica incluida (2 vías).
- Caño cascada INOX (299.903.04).
- Ducha móvil anticalcárea (202.639.01).
- Flexo doble engatillado.

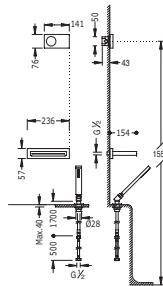

Cr | 092.865.70 |



Cr | 092.885.70 |



**Kit electrónico de bañera termostático empotrado
SHOWER TECHNOLOGY**

- Control electrónico incluido.
- Centralita termostática electrónica incluida (2 vías).
- Desagüe bañera y válvula de llenado cuadrada CASCADA con reboadero (1.34.534.40).
- Sifón PVC bañera (1.34.634.60).
- Ducha móvil anticalcárea (202.639.01).
- Flexo doble engatillado.

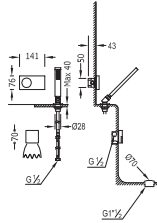

Cr	092.865.71

Cr	092.885.71



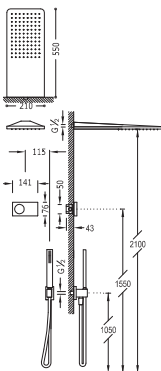

**Kit electrónico de ducha termostático empotrado
SHOWER TECHNOLOGY**

- Control electrónico incluido.
- Centralita termostática electrónica incluida (2 vías).
- Rociador ducha INOX a pared 210x550 mm. (299.903.07).
- Soporte con toma pared (207.182.01).
- Ducha móvil anticalcárea (034.116.01).
- Flexo SATIN (91.34.609.15).

BELSABADA
Cr | 092.865.54 |

Cr | 092.885.54 | **N**

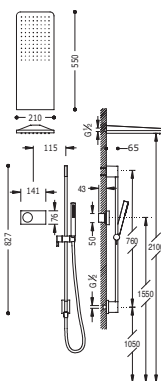

**Kit electrónico de ducha termostático empotrado
SHOWER TECHNOLOGY**

- Control electrónico incluido.
- Centralita termostática electrónica incluida (2 vías).
- Rociador ducha INOX a pared 210x550 mm. (299.903.07).
- Barra deslizante con toma de agua a pared. Long 760 mm. (034.931.99).
- Ducha móvil anticalcárea (034.116.01).
- Flexo SATIN (91.34.609.15).

BELSABADA
Cr | 092.865.82 |

Cr | 092.885.82 | **N**



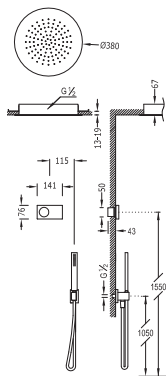

Kit electrónico de ducha termostático empotrado
SHOWER TECHNOLOGY

- Control electrónico incluido.
- Centralita termostática electrónica incluida (2 vías).
- Rociador ducha INOX a techo Ø 380 mm. (1.34.940).
- Soporte con toma pared (207.182.01).
- Ducha móvil anticalcárea (034.116.01).
- Flexo SATIN (91.34.609.15).

		Cr	092.865.55	
		Cr	092.885.55	

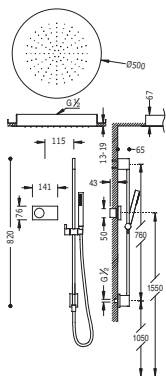

Kit electrónico de ducha termostático empotrado
SHOWER TECHNOLOGY

- Control electrónico incluido.
- Centralita termostática electrónica incluida (2 vías).
- Rociador ducha INOX a techo Ø 500 mm. (1.34.950).
- Barra deslizante con toma de agua a pared. Long 760 mm. (034.931.99).
- Ducha móvil anticalcárea (034.116.01).
- Flexo SATIN (91.34.609.15).

		Cr	092.865.83	
		Cr	092.885.83	





**Kit electrónico de ducha termostático empotrado
SHOWER TECHNOLOGY**

- Control electrónico incluido.
- Centralita termostática electrónica incluida (2 vías).
- Rociador ducha INOX a techo Ø 380 mm. (1.34.940).
- Barra deslizante con toma de agua a techo. Long 1.040 mm.
- Ducha móvil anticalcárea (034.116.01).
- Flexo SATIN (91.34.609.15).

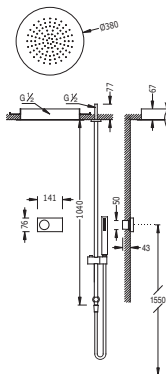

**Kit electrónico de ducha termostático empotrado
SHOWER TECHNOLOGY**

- Control electrónico incluido.
- Centralita termostática electrónica incluida (2 vías).
- Rociador ducha INOX a techo Ø 500 mm. (1.34.950).
- Soporte con toma pared (207.182.01).
- Ducha móvil anticalcárea (034.116.01).
- Flexo SATIN (91.34.609.15).

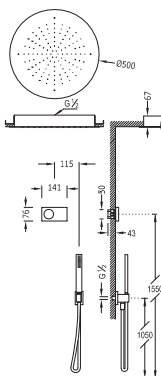

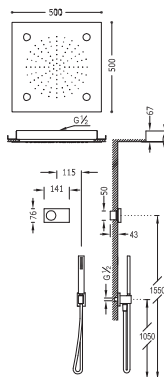

**Kit electrónico de ducha termostático empotrado
SHOWER TECHNOLOGY con CROMOTERAPIA**

- Control electrónico incluido.
- Centralita termostática electrónica incluida (2 vías).
- Rociador ducha INOX a techo 500x500 mm. (299.962.01).
- Soporte con toma pared (207.182.01).
- Ducha móvil anticalcárea (034.116.01).
- Flexo SATIN (91.34.609.15).

Cr **092.865.66**

Cr **092.885.66**

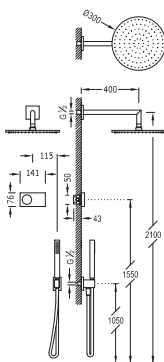

**Kit electrónico de ducha termostático empotrado
SHOWER TECHNOLOGY**

- Control electrónico incluido.
- Centralita termostática electrónica incluida (2 vías).
- Ducha fija Ø 300 mm. con rótula. Material Latón (1.34.137.30).
- Soporte con toma pared (207.182.01).
- Ducha móvil anticalcárea (034.116.01).
- Flexo SATIN (91.34.609.15).

Cr **092.865.58**

Cr **092.885.58**



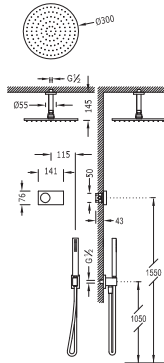

**Kit electrónico de ducha termostático empotrado
SHOWER TECHNOLOGY**

- Control electrónico incluido.
- Centralita termostática electrónica incluida (2 vías).
- Ducha fija Ø 300 mm. con rótula. Material Latón (1.34.137.30).
- Soporte con toma pared (207.182.01).
- Ducha móvil anticalcárea (034.116.01).
- Flexo SATIN (91.34.609.15).

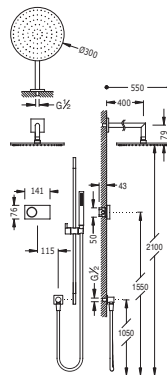

**Kit electrónico de ducha termostático empotrado
SHOWER TECHNOLOGY**

- Control electrónico incluido.
- Centralita termostática electrónica incluida (2 vías).
- Ducha fija Ø 300 mm. con rótula. Material Latón (1.34.137.30).
- Barra de ducha long. 760 mm. (034.637.01).
- Ducha móvil anticalcárea (034.116.01).
- Flexo SATIN (91.34.609.15).



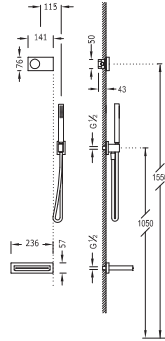

Kit electrónico de bañera termostático empotrado
SHOWER TECHNOLOGY

- Control electrónico incluido.
- Centralita termostática electrónica incluida (2 vías).
- Caño cascada INOX (299.903.04).
- Soporte con toma pared (207.182.01).
- Ducha móvil anticalcárea (034.116.01).
- Flexo SATIN (91.34.609).

		BELEGUVA
Cr	092.865.56	
Cr	092.885.56	



Kit electrónico de bañera termostático empotrado
SHOWER TECHNOLOGY

- Control electrónico incluido.
- Centralita termostática electrónica incluida (2 vías).
- Desague bañera y válvula de llenado redonda CASCADA con rebosadero (1.34.534.30).
- Sifón PVC bañera (1.34.634.60).
- Ducha masaje, 5 posiciones. (299.631.06).
- Flexo doble engatillado.

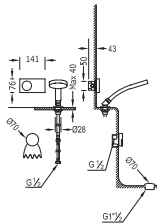

		BELEGUVA
Cr	092.865.73	
Cr	092.885.73	



PARA 3 VÍAS

Ref.:

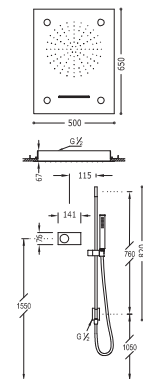

**Kit electrónico de ducha termostático empotrado
SHOWER TECHNOLOGY con CROMOTERAPIA**

- Control electrónico incluido.
 - Centralita termostática electrónica incluida (3 vías).
 - Rociador ducha INOX a techo con 2 tipos de chorro 500x650 mm. (299.972.01).
 - Barra deslizante con toma de agua a pared. Long 760 mm. (034.932-99).
 - Ducha móvil anticalcárea (202.639.01).
 - Flexo SATIN (91.34.609.15).
- IMPORTANTE: Montar un desagüe de >50 l/min.

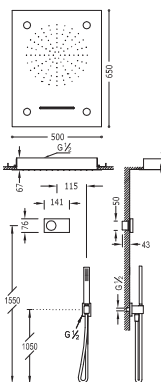

**Kit electrónico de ducha termostático empotrado
SHOWER TECHNOLOGY con CROMOTERAPIA**

- Control electrónico incluido.
 - Centralita termostática electrónica incluida (3 vías).
 - Rociador ducha INOX a techo con 2 tipos de chorro 500x650 mm. (299.972.01).
 - Soporte con toma pared (207.182.01).
 - Ducha móvil anticalcárea (202.639.01).
 - Flexo SATIN (91.34.609.15).
- IMPORTANTE: Montar un desagüe de >50 l/min.



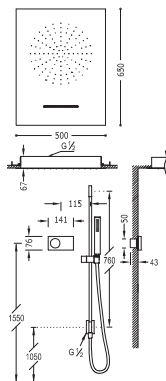

Kit electrónico de ducha termostático empotrado SHOWER TECHNOLOGY

- Control electrónico incluido.
 - Centralita termostática electrónica incluida (3 vías).
 - Rociador ducha INOX a techo con 2 tipos de chorro 500x650 mm. (299.970.01).
 - Barra deslizante con toma de agua a pared. Long 760 mm. (034.932.99).
 - Ducha móvil anticalcárea (202.639.01).
 - Flexo SATIN (91.34.609.15).
- IMPORTANTE: Montar un desagüe de >50 l/min.

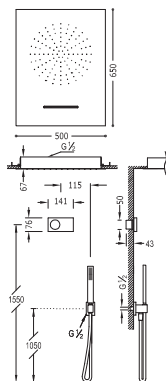

Kit electrónico de ducha termostático empotrado SHOWER TECHNOLOGY

- Control electrónico incluido.
 - Centralita termostática electrónica incluida (3 vías).
 - Rociador ducha INOX a techo con 2 tipos de chorro 500x650 mm. (299.970.01).
 - Soporte con toma pared (207.182.01).
 - Ducha móvil anticalcárea (202.639.01).
 - Flexo SATIN (91.34.609.15).
- IMPORTANTE: Montar un desagüe de >50 l/min.



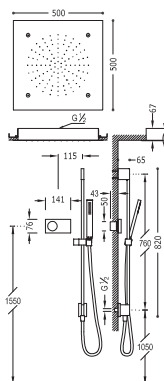

**Kit electrónico de ducha termostático empotrado
SHOWER TECHNOLOGY**

- Control electrónico incluido.
 - Centralita termostática electrónica incluida (3 vías).
 - Rociador ducha INOX a techo con 2 tipos de chorro 500x500 mm. (299.954.01).
 - Barra deslizante con toma de agua a pared. Long 760 mm. (034.932-99).
 - Ducha móvil anticalcárea (202.639.01).
 - Flexo SATIN (91.34.609.15).
- IMPORTANTE: Montar un desagüe de >50 l/min.

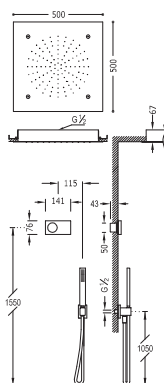

**Kit electrónico de ducha termostático empotrado
SHOWER TECHNOLOGY**

- Control electrónico incluido.
 - Centralita termostática electrónica incluida (3 vías).
 - Rociador ducha INOX a techo con 2 tipos de chorro 500x500 mm. (299.954.01).
 - Soporte con toma pared (207.182.01).
 - Ducha móvil anticalcárea (202.639.01).
 - Flexo SATIN (91.34.609.15).
- IMPORTANTE: Montar un desagüe de >50 l/min.



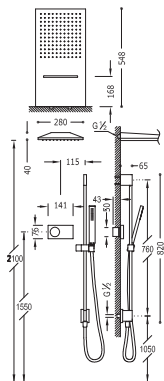

**Kit electrónico de ducha termostático empotrado
SHOWER TECHNOLOGY**

- Control electrónico incluido.
- Centralita termostática electrónica incluida (3 vías).
- Rociador ducha INOX a pared con 2 tipos de chorro 280x550 mm (299.903.01).
- Barra deslizante con toma de agua a pared. Long 760 mm. (034.932.99).
- Ducha móvil anticalcárea (202.639.01).
- Flexo SATIN (91.34.609.15).

IMPORTANTE: Montar un desagüe de >50 l/min.

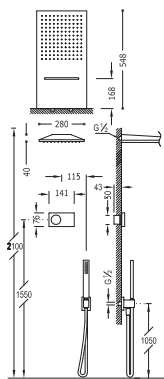

**Kit electrónico de ducha termostático empotrado
SHOWER TECHNOLOGY**

- Control electrónico incluido.
- Centralita termostática electrónica incluida (3 vías).
- Rociador ducha INOX a pared con 2 tipos de chorro 280x550 mm (299.903.01).
- Soporte con toma pared (207.182.01).
- Ducha móvil anticalcárea (202.639.01).
- Flexo SATIN (91.34.609.15).

IMPORTANTE: Montar un desagüe de >50 l/min.



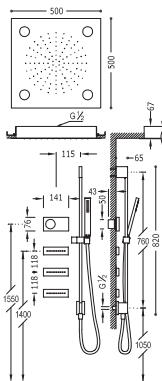

**Kit electrónico de ducha termostático empotrado
SHOWER TECHNOLOGY con CROMOTERAPIA**

- Control electrónico incluido.
- Centralita termostática electrónica incluida (3 vías).
- Rociador ducha INOX a techo 500x500 mm. (299.962.01).
- 3 jets antical (299.515.04).
- Barra deslizante con toma de agua a pared. Long 760 mm. (034.932-99).
- Ducha móvil anticalcárea (202.639.01).
- Flexo SATIN (91.34.609.15).

IMPORANTE: Montar un desagüe de >50 l/min.

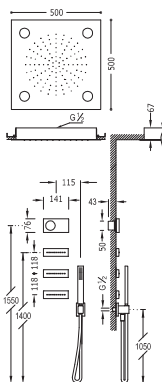

**Kit electrónico de ducha termostático empotrado
SHOWER TECHNOLOGY con CROMOTERAPIA**

- Control electrónico incluido.
- Centralita termostática electrónica incluida (3 vías).
- Rociador ducha INOX a techo 500x500 mm. (299.962.01).
- 3 jets antical (299.515.04).
- Soporte con toma pared (207.182.01).
- Ducha móvil anticalcárea (202.639.01).
- Flexo SATIN (91.34.609.15).

IMPORANTE: Montar un desagüe de >50 l/min.



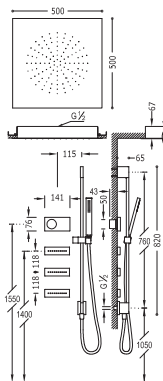

**Kit electrónico de ducha termostático empotrado
SHOWER TECHNOLOGY**

- Control electrónico incluido.
 - Centralita termostática electrónica incluida (3 vías).
 - Rociador ducha INOX a techo 500x500 mm. (299.953.02).
 - 3 jets antical (299.515.04).
 - Barra deslizante con toma de agua a pared. Long 760 mm. (034.932.99).
 - Ducha móvil anticalcárea (202.639.01).
 - Flexo SATIN (91.34.609.15).
- IMPORTANTE: Montar un desagüe de >50 l/min.

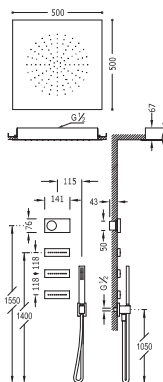

**Kit electrónico de ducha termostático empotrado
SHOWER TECHNOLOGY**

- Control electrónico incluido.
 - Centralita termostática electrónica incluida (3 vías).
 - Rociador ducha INOX a techo 500x500 mm. (299.953.02).
 - 3 jets antical (299.515.04).
 - Soporte con toma pared (207.182.01).
 - Ducha móvil anticalcárea (202.639.01).
 - Flexo SATIN (91.34.609.15).
- IMPORTANTE: Montar un desagüe de >50 l/min.



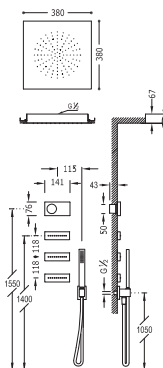

**Kit electrónico de ducha termostático empotrado
SHOWER TECHNOLOGY**

- Control electrónico incluido.
- Centralita termostática electrónica incluida (3 vías).
- Rociador ducha INOX a techo 380x380 mm. (299.953.01).
- 3 jets antical (299.515.04).
- Soporte con toma pared (207.182.01).
- Ducha móvil anticalcárea (202.639.01).
- Flexo SATIN (91.34.609.15).

IMPORTANTE: Montar un desague de >50 l/min.



Cr | 092.863.13 |



Cr | 092.863.13 |

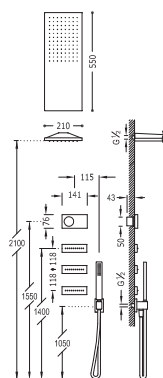

**Kit electrónico de ducha termostático empotrado
SHOWER TECHNOLOGY**

- Control electrónico incluido.
- Centralita termostática electrónica incluida (3 vías).
- Rociador ducha INOX a pared 210x550 mm. (299.903.02).
- 3 jets antical (299.515.04).
- Soporte con toma pared (207.182.01).
- Ducha móvil anticalcárea (202.639.01).
- Flexo SATIN (91.34.609.15).

IMPORTANTE: Montar un desague de >50 l/min.



Cr | 092.863.14 |



Cr | 092.863.14 |



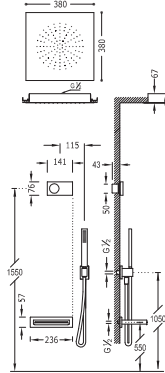

Kit electrónico de bañera termostático empotrado SHOWER TECHNOLOGY

- Control electrónico incluido.
- Centralita termostática electrónica incluida (3 vías).
- Rociador ducha INOX a techo 380x380 mm. (299.953.01).
- Caño cascada INOX (299.903.04).
- Soporte con toma pared (207.182.01).
- Ducha móvil anticalcárea (202.639.01).
- Flexo SATIN (91.34.609.15).

IMPORTANTE: Montar un desagüe de >50 l/min.

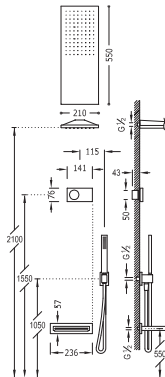
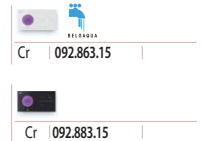

Kit electrónico de bañera termostático empotrado SHOWER TECHNOLOGY

- Control electrónico incluido.
- Centralita termostática electrónica incluida (3 vías).
- Rociador ducha INOX a pared 210x350 mm. (299.903.02).
- Caño cascada INOX (299.903.04).
- Soporte con toma pared (207.182.01).
- Ducha móvil anticalcárea (202.639.01).
- Flexo SATIN (91.34.609.15).

IMPORTANTE: Montar un desagüe de >50 l/min.

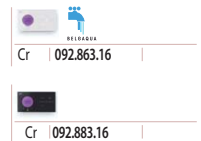

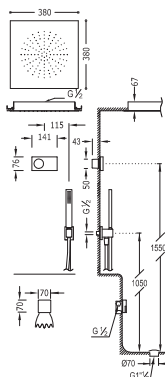

**Kit electrónico de bañera termostático empotrado
SHOWER TECHNOLOGY**

- Control electrónico incluido.
- Centralita termostática electrónica incluida (3 vías).
- Rociador ducha INOX a techo 380x380 mm. (299.953.01).
- Desagüe para bañera con sistema de llenado tipo CASCADA y rebosadero (1.34.534.40).
- Sifón PVC bañera (1.34.634.60).
- Soporte con toma pared (207.182.01).
- Ducha móvil anticalcárea (202.639.01).
- Flexo SATIN (91.34.609.15).

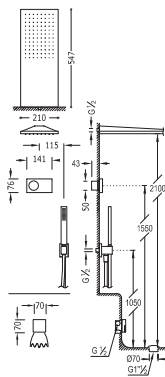

**Kit electrónico de bañera termostático empotrado
SHOWER TECHNOLOGY**

- Control electrónico incluido.
- Centralita termostática electrónica incluida (3 vías).
- Rociador ducha INOX a pared 210x550 mm. (299.903.02).
- Desagüe para bañera con sistema de llenado tipo CASCADA y rebosadero (1.34.534.40).
- Sifón PVC bañera (1.34.634.60).
- Soporte con toma pared (207.182.01).
- Ducha móvil anticalcárea (202.639.01).
- Flexo SATIN (91.34.609.15).



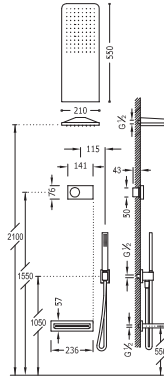

Kit electrónico de bañera termostático empotrado
SHOWER TECHNOLOGY

- Control electrónico incluido.
- Centralita termostática electrónica incluida (3 vías).
- Rociador ducha INOX a pared 210x550 mm. (299.903.07).
- Caño cascada INOX (299.903.04).
- Soporte con toma pared (207.182.01).
- Ducha móvil anticalcárea (202.639.01).
- Flexo SATIN (91.34.609.15).

IMPORTANTE: Montar un desagüe de >50 l/min.

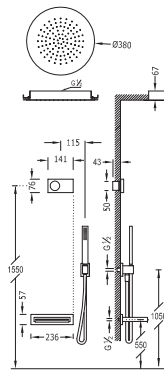

Kit electrónico de bañera termostático empotrado
SHOWER TECHNOLOGY

- Control electrónico incluido.
- Centralita termostática electrónica incluida (3 vías).
- Rociador ducha INOX a techo Ø 380 mm. (1.34.940).
- Caño cascada INOX (299.903.04).
- Soporte con toma pared (207.182.01).
- Ducha móvil anticalcárea (034.116.01).
- Flexo SATIN (91.34.609.15).

IMPORTANTE: Montar un desagüe de >50 l/min.



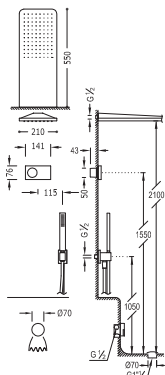

Kit electrónico de bañera termostático empotrado
SHOWER TECHNOLOGY

- Control electrónico incluido.
- Centralita termostática electrónica incluida (3 vías).
- Rociador ducha INOX a pared 210x550 mm. (299.903.07).
- Desagüe para bañera con sistema de llenado tipo CASCADA y rebosadero (1.34.534.30).
- Sifón PVC bañera (1.34.634.60).
- Soporte con toma pared (207.182.01).
- Ducha móvil anticalcárea (202.639.01).
- Flexo SATIN (91.34.609.15).

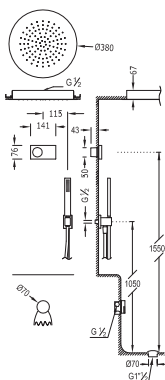

Kit electrónico de bañera termostático empotrado
SHOWER TECHNOLOGY

- Control electrónico incluido.
- Centralita termostática electrónica incluida (3 vías).
- Rociador ducha INOX a techo Ø 380 mm. (1.34.940).
- Desagüe para bañera con sistema de llenado tipo CASCADA y rebosadero (1.34.534.30).
- Sifón PVC bañera (1.34.634.60).
- Soporte con toma pared (207.182.01).
- Ducha móvil anticalcárea (034.116.01).
- Flexo SATIN (91.34.609.15).



PARA 4 VÍAS

Ref.:

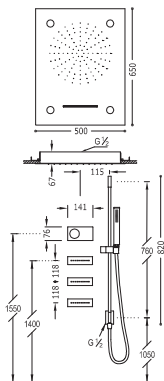

Kit electrónico de ducha termostático empotrado SHOWER TECHNOLOGY con CROMOTERAPIA

- Control electrónico incluido.
 - Centralita termostática electrónica incluida (4 vías).
 - Rociador ducha INOX a techo con 2 tipos de chorro 500x650 mm. (299.972.01).
 - 3 jets antical (299.515.04).
 - Barra deslizante con toma de agua a pared. Long 760 mm. (034.932.99).
 - Ducha móvil anticalcárea (202.639.01).
 - Flexo SATIN (91.34.609.15).
- IMPORTANTE: Montar un desagüe de >50 l/min.

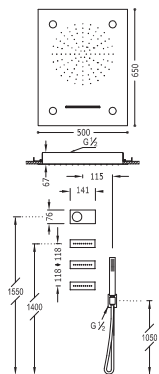

Kit electrónico de ducha termostático empotrado SHOWER TECHNOLOGY con CROMOTERAPIA

- Control electrónico incluido.
 - Centralita termostática electrónica incluida (4 vías).
 - Rociador ducha INOX a techo con 2 tipos de chorro 500x650 mm. (299.972.01).
 - 3 jets antical (299.515.04).
 - Soporte con toma pared (207.182.01).
 - Ducha móvil anticalcárea (202.639.01).
 - Flexo SATIN (91.34.609.15).
- IMPORTANTE: Montar un desagüe de >50 l/min.



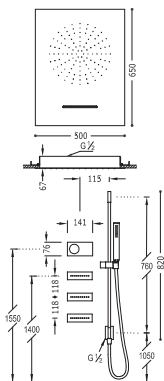

**Kit electrónico de ducha termostático empotrado
SHOWER TECHNOLOGY**

- Control electrónico incluido.
- Centralita termostática electrónica incluida (4 vías).
- Rociador ducha INOX a techo con 2 tipos de chorro 500x650 mm. (299.970.01).
- 3 jets antical (299.515.04).
- Barra deslizante con toma de agua a pared. Long 760 mm. (034.932.99).
- Ducha móvil anticalcárea (202.639.01).
- Flexo SATIN (91.34.609.15).

IMPORTANTE: Montar un desagüe de >50 l/min.



Cr | 092.864.03 |



Cr | 092.884.03 |

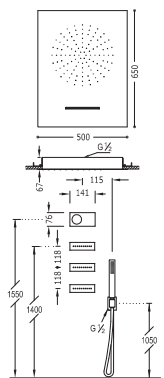

**Kit electrónico de ducha termostático empotrado
SHOWER TECHNOLOGY**

- Control electrónico incluido.
- Centralita termostática electrónica incluida (4 vías).
- Rociador ducha INOX a techo con 2 tipos de chorro 500x650 mm. (299.970.01).
- 3 jets antical (299.515.04).
- Soporte con toma pared (207.182.01).
- Ducha móvil anticalcárea (202.639.01).
- Flexo SATIN (91.34.609.15).

IMPORTANTE: Montar un desagüe de >50 l/min.



Cr | 092.864.04 |



Cr | 092.884.04 |



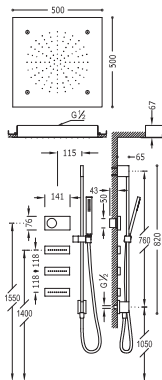

**Kit electrónico de ducha termostático empotrado
SHOWER TECHNOLOGY**

- Control electrónico incluido.
 - Centralita termostática electrónica incluida (4 vías).
 - Rociador ducha INOX a techo con 2 tipos de chorro 500x500 mm. (299.954.01).
 - 3 jets antical (299.515.04).
 - Barra deslizante con toma de agua a pared. Long 760 mm. (034.932.99).
 - Ducha móvil anticalcárea (202.639.01).
 - Flexo SATIN (91.34.609.15).
- IMPORTANTE: Montar un desagüe de >50 l/min.



 
Cr **092.864.05**

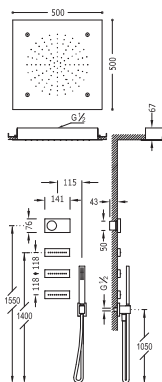

 
Cr **092.884.05** 



**Kit electrónico de ducha termostático empotrado
SHOWER TECHNOLOGY**

- Control electrónico incluido.
 - Centralita termostática electrónica incluida (4 vías).
 - Rociador ducha INOX a techo con 2 tipos de chorro 500x500 mm. (299.954.01).
 - 3 jets antical (299.515.04).
 - Soporte con toma pared (207.182.01).
 - Ducha móvil anticalcárea (202.639.01).
 - Flexo SATIN (91.34.609.15).
- IMPORTANTE: Montar un desagüe de >50 l/min.

 
Cr **092.864.06**

 
Cr **092.884.06** 



Ref: |

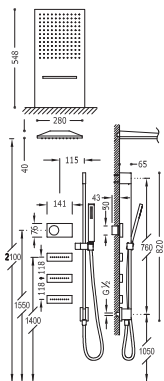

Kit electrónico de ducha termostático empotrado SHOWER TECHNOLOGY

- Control electrónico incluido.
- Centralita termostática electrónica incluida (4 vías).
- Rociador ducha INOX a pared con 2 tipos de chorro. 280x550 mm (299.903.01).
- 3 jets antical (299.515.04).
- Barra deslizante con toma de agua a pared. Long 760 mm. (034.932.99).
- Ducha móvil anticalcárea (202.639.01).
- Flexo SATIN (91.34.609.15).

IMPORTANTE: Montar un desagüe de >50 l/min.

Cr | 092.864.07

Cr | 092.884.07

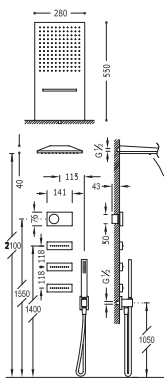

Kit electrónico de ducha termostático empotrado SHOWER TECHNOLOGY

- Control electrónico incluido.
- Centralita termostática electrónica incluida (4 vías).
- Rociador ducha INOX a pared con 2 tipos de chorro. 280x550 mm (299.903.01).
- 3 jets antical (299.515.04).
- Soporte con toma pared (207.182.01).
- Ducha móvil anticalcárea (202.639.01).
- Flexo SATIN (91.34.609.15).

IMPORTANTE: Montar un desagüe de >50 l/min.

Cr | 092.864.08

Cr | 092.884.08





LA TECNOLOGÍA DE LOS MONOMANDOS DEL FUTURO

Utilizar un grifo Mono-term® en tu ducha o bañera tiene muchas ventajas. La misma facilidad de uso que cualquier otro monomando pero con una tecnología avanzada que ofrece un confort y unas prestaciones similares a las de una termostática.

SEGURIDAD Y EFICIENCIA

Los monomandos de superficie mono-term® llevan incorporado el sistema antiquemaduras touch-cool, que consigue mantener la superficie del grifo a una temperatura apta para el tacto, evitando quemaduras.

Incorporan una doble cámara que permite aislar el agua caliente de forma que la temperatura no traspase hasta la superficie.



MÁS QUE UN MONOMANDO

- 1/ La temperatura se mantiene constante ante variaciones de presión o de temperatura ($\pm 2^{\circ}\text{C}$).
- 2/ Se consigue la temperatura deseada con mayor rapidez que con otro tipo de grifo monomando.
- 3/ El gran ángulo de giro de la maneta permite regular al mismo tiempo, de una forma suave, el caudal y la temperatura deseada con exactitud y sin esfuerzo.
- 4/ Variedad de conjuntos para ducha o bañera. Modelos empotrados y de superficie.
- 5/ Los mandos incorporan la marca 38°C, demostrando la precisión en la elección de la temperatura.
- 6/ Limita la temperatura a un máximo de 48/49°C, con lo que se evita el riesgo de quemaduras.

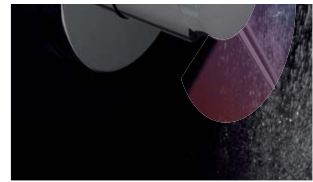

UN CARTUCHO REVOLUCIONARIO

Con la creación del cartucho patentado Mono-term[®], estos monomandos son los únicos con estas características disponibles en el mercado.

- Los discos del cartucho están contruidos de material cerámico y son totalmente anticalcáreos e insensibles a las depositciones de cal.
- Su nivel acústico es más bajo respecto a otros cartuchos cerámicos.
- Sin filtros ni válvulas antirretorno, es apto para aguas duras (cal, arenilla...).
- En el caso, improbable, de que se interrumpa el suministro de agua fría, el cartucho corta automáticamente el agua caliente.

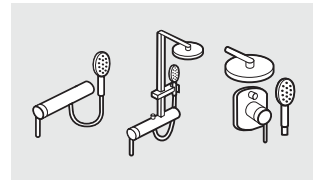

MONOMANDO DUCHA MONO-TERM®

Ref.:

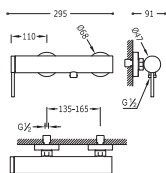

MONO-TERM® ducha

Ducha de mano anticalcárea (034.116.01) con soporte orientable y flexo SATIN (91.34.609.15).



299.195.05
BELBARRA
Cr 062.168.01

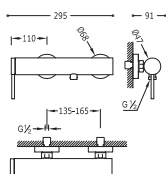

MONO-TERM® ducha

Ducha de mano masaje Ø 100 mm. (5 funciones) (1.34.748) con soporte orientable. Flexo SATIN (91.34.609.15).



299.195.05
BELBARRA
Cr 201.167.01

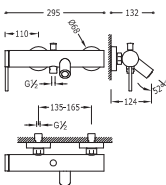

MONO-TERM® bañera-ducha

Ducha de mano anticalcárea (034.116.01) con soporte orientable y flexo SATIN (91.34.609).



299.195.05
BELBARRA
Cr 062.181.01

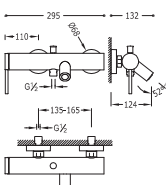

MONO-TERM® bañera-ducha

Ducha de mano masaje Ø 100 mm. (5 funciones) (1.34.748) con soporte orientable. Flexo SATIN (91.34.609).



299.195.05
BELBARRA
Cr 201.170.01

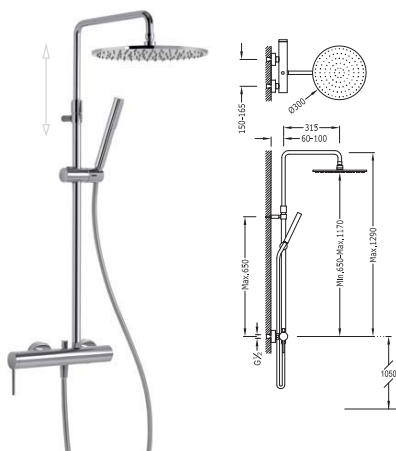

Conjunto ducha MONO-TERM®

- Ducha fija Ø 300 mm. con rótula. Material Latón (1.34.137.30).
- Ducha móvil anticalcárea (034.116.01).
- Flexo SATIN (91.34.609.15).
- Barra telescópica.



299.195.05  RELAXAQUA
Cr | 062.378.01



Conjunto ducha MONO-TERM®

- Ducha fija Ø 250 mm. con rótula. (1.34.137.26).
- Ducha móvil masaje Ø 100 mm. (5 funciones) (1.34.748).
- Flexo SATIN (91.34.609.15).
- Barra telescópica.



299.195.05  RELAXAQUA
Cr | 201.195.01

CONJUNTOS EMPOTRADOS MONO-TERM®

Ref.:

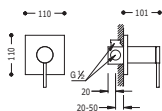

MONO-TERM® de empotrar (1 vía)

con cierre y regulación de caudal.
- Cuerpo empotrado incluido



299.195.05 BELGARA
Cr 201.177.01

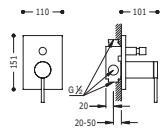

MONO-TERM® de empotrar (2 vías)

con cierre y regulación de caudal.
- Cuerpo empotrado incluido



299.195.05 BELGARA
Cr 201.180.01

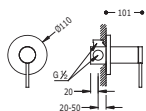

MONO-TERM® de empotrar (1 vía)

con cierre y regulación de caudal.
- Cuerpo empotrado incluido



299.195.05 BELGARA
Cr 201.177.02

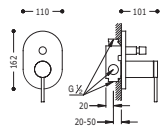

MONO-TERM® de empotrar (2 vías)

con cierre y regulación de caudal.
- Cuerpo empotrado incluido



299.195.05 BELGARA
Cr 201.180.02

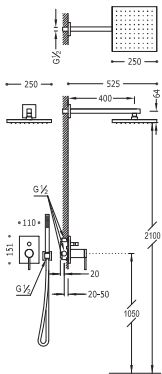

Kit MONO-TERM® de empotrar ducha

con cierre y regulación de caudal.
- Cuerpo empotrado incluido
- Ducha fija 250x250 mm. con rótula. (1.34.138.26).
- Soporte con toma pared (006.182.01).
- Ducha móvil anticalcárea (006.639.01).
- Flexo SATIN (91.34.609.15).



299.195.05 BELGARA
Cr 201.180.06

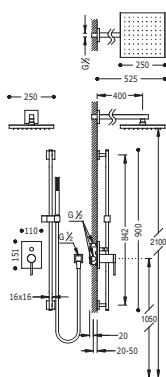

Kit MONO-TERM® de empotrar ducha

- con cierre y regulación de caudal.
- Cuerpo empotrado incluido
- Ducha fija 250x250 mm. con rótula. (1.34.138.26).
- Barra deslizante long. 842 mm. (1.07.935).
- Codo toma pared (006.183.01).
- Ducha móvil anticalcárea (006.639.01).
- Flexo SATIN (91.34.609).



299.195.05  
Cr | 201.180.07 |

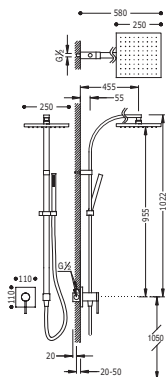

Kit MONO-TERM® de empotrar ducha

- con cierre y regulación de caudal.
- Cuerpo empotrado incluido
- Ducha fija 250x250 mm. con rótula. (1.34.138.26).
- Ducha móvil anticalcárea (006.639.01).
- Flexo SATIN (91.34.609.15).
- Con toma pared.



299.195.05  
Cr | 201.177.04 |

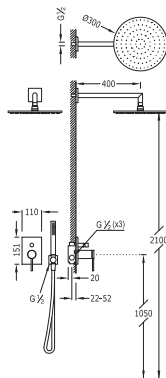

Kit MONO-TERM® de empotrar ducha

- con cierre y regulación de caudal.
- Cuerpo empotrado incluido
- Ducha fija Ø 300 mm. con rótula. Material Latón. (1.34.137.30).
- Soporte con toma pared (061.182.01).
- Ducha móvil anticalcárea (034.116.01).
- Flexo SATIN (91.34.609.15).



299.195.05  
Cr | 062.180.03 |



N

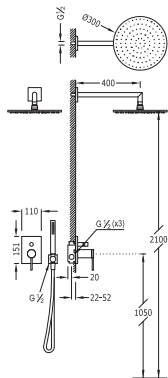

Kit MONO-TERM® de empotrar ducha

- con cierre y regulación de caudal.
- Cuerpo empotrado incluido
- Ducha fija Ø 300 mm. con rótula. Material Latón.
- Soporte con toma pared.
- Ducha móvil anticalcárea (ø34.116.01).
- Flexo.



299.195.05

AC	062.180.03.AC
NM	062.180.03.NM
BM	062.180.03.BM

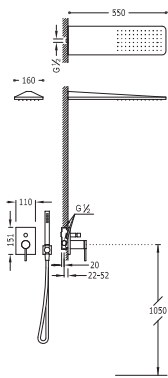

Kit MONO-TERM® de empotrar ducha

- con cierre y regulación de caudal.
- Cuerpo empotrado incluido
- Ducha INOX 160x550 mm. (299.903.06).
- Soporte con toma pared. (061.182.01).
- Ducha móvil anticalcárea. (034.116.01).
- Flexo SATIN (91.34.609.15).



299.195.05

RELOJERIA

Cr 062.180.10

N

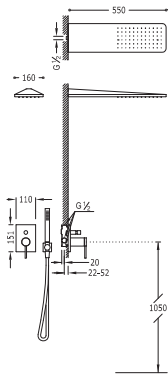

Kit MONO-TERM® de empotrar ducha

- con cierre y regulación de caudal.
- Cuerpo empotrado incluido
- Ducha INOX 160x550 mm.
- Soporte con toma pared.
- Ducha móvil anticalcárea.
- Flexo.



299.195.05

AC	062.180.10.AC
NM	062.180.10.NM
BM	062.180.10.BM

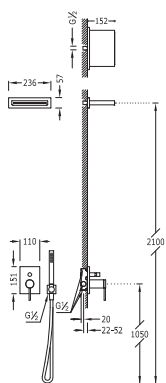

Kit MONO-TERM® de empotrar ducha

- con cierre y regulación de caudal.
- Cuerpo empotrado incluido
 - Ducha INOX con cascada 152x200 mm. (299.903.04).
 - Soporte con toma pared (061.182.01).
 - Ducha móvil anticalcárea (034.116.01).
 - Flexo SATIN (91.34.609.15).



299.195.05
Cr | 062.180.06

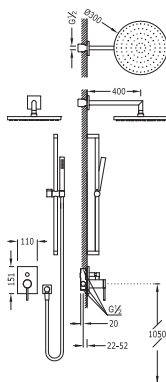

Kit MONO-TERM® de empotrar ducha

- con cierre y regulación de caudal.
- Cuerpo empotrado incluido
 - Ducha fija Ø 300 mm. con rótula. Material Latón. (1.34.137.30).
 - Codo toma pared (061.183.01).
 - Barra deslizante long. 673 mm. (034.637.06).
 - Ducha móvil anticalcárea (034.116.01).
 - Flexo SATIN (91.34.609.15).



299.195.05
Cr | 062.180.07

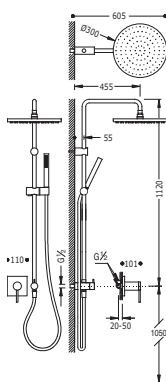

Kit MONO-TERM® de empotrar ducha

- con cierre y regulación de caudal.
- Cuerpo empotrado incluido
 - Ducha fija Ø 300 mm. con rótula. Material Latón. (1.34.137.30).
 - Ducha móvil anticalcárea (034.116.01).
 - Flexo SATIN (91.34.609.15).
 - Con toma pared.



299.195.05
Cr | 062.180.08



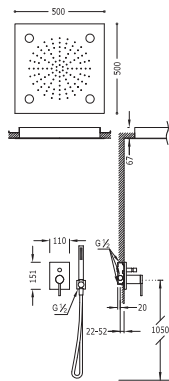

Kit MONO-TERM® de empotrar ducha CROMOTERAPIA

- con cierre y regulación de caudal.
- Cuerpo empotrado incluido
- Rociador ducha a techo 500x500 mm. (299.962.01).
- Soporte con toma pared (061.182.01).
- Ducha móvil anticalcárea (034.116.01).
- Flexo SATIN (91.34.609.15).

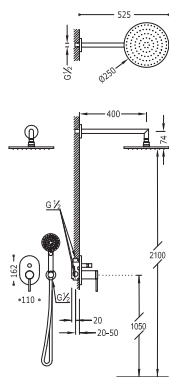

Kit MONO-TERM® de empotrar ducha

- con cierre y regulación de caudal.
- Cuerpo empotrado incluido
- Ducha fija Ø 250 mm. con rótula. (1.34.137.26).
- Soporte con toma pared (205.182.01).
- Ducha móvil masaje Ø 100 mm. (5 funciones) (1.34.748).
- Flexo SATIN (91.34.609.15).

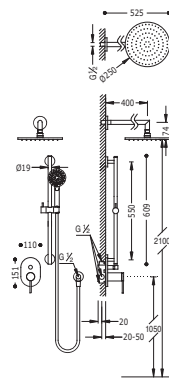

Kit MONO-TERM® de empotrar ducha

- con cierre y regulación de caudal.
- Cuerpo empotrado incluido
- Ducha fija Ø 250 mm. con rótula. (1.34.137.26).
- Barra deslizante long. 550 mm. (1.34.618).
- Codo toma pared (205.183.01).
- Ducha móvil masaje Ø 100 mm. (5 funciones) (1.34.748).
- Flexo SATIN (91.34.609.15).



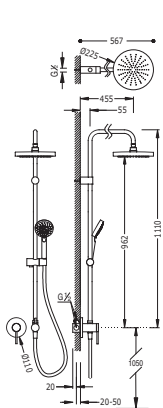

Kit MONO-TERM® de empotrar ducha

- con cierre y regulación de caudal.
- Cuerpo empotrado incluido
- Ducha fija Ø 225 mm. con rótula. (299.632.01).
- Ducha móvil masaje Ø 100 mm. (5 funciones) (1.34.748).
- Flexo SATIN (91.34.609.15).
- Con toma pared.



299.195.05 BELARUX
Cr | 201.177.03

MONO-TERM® de empotrar baño-ducha

- con cierre y regulación de caudal. (2 vías).
- Desagüe bañera y válvula de llenado redonda CASCADA con rebosadero (1.34.534.30).
- Sifón PVC bañera (1.34.634.60).
- Ducha móvil masaje Ø 100 mm. (5 funciones) (299.631.06).
- Flexo doble engatillado.

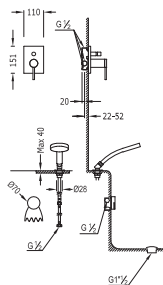

299.195.05 BELARUX
Cr | 062.180.12

MONO-TERM® de empotrar baño-ducha

- con cierre y regulación de caudal. (2 vías).
- Desagüe bañera y válvula de llenado redonda CASCADA con rebosadero (1.34.534.30).
- Sifón PVC bañera (1.34.634.60).
- Soporte con toma pared (061.182.01).
- Ducha móvil masaje Ø 100 mm. (5 funciones) (299.631.06).
- Flexo SATIN (91.34.609).

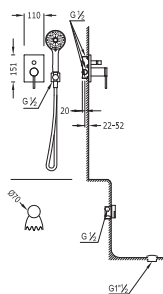

299.195.05 BELARUX
Cr | 062.180.13



MÁS FUNCIONES CON LA MISMA FACILIDAD DE USO



Los monomandos se caracterizan por su funcionalidad. Esta gama empotrada de monomandos no renuncia a ello y añade belleza y simplicidad en su diseño con la gran ventaja de ofrecer 3 vías distintas de salida del agua.

SELECTOR DE FUNCIONES

1/ Un único mando abre y cierra el paso del agua, ajusta la temperatura y regula el caudal.

2/ Un selector de funciones te permite elegir cualquiera de las tres posibles salidas del agua.



-  Rociador de techo / pared con efecto lluvia.
-  Ducha de mano.
-  Segunda función del rociador / jets / caño bañera.

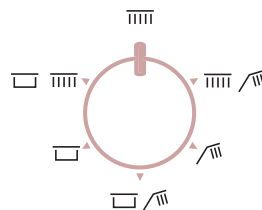



INSTALACIÓN EMPOTRADA

El control y el soporte de ducha suministrados en los kits están integrados en un solo cuerpo empotrado no divisible.

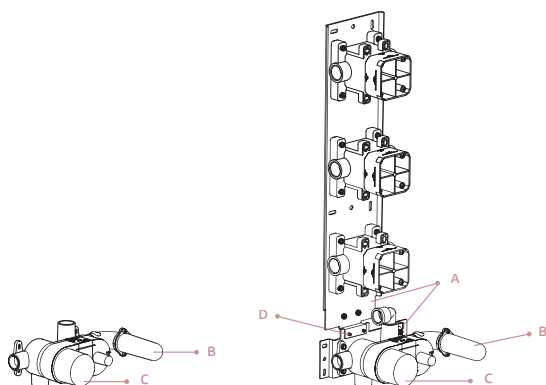

- A** Perfil de instalación a muro o pladur nivelable.
- B** Soporte con toma de ducha integrado y protector estanco.
- C** Protector extraíble. Corte exterior para proteger las partes cromadas.
- D** Alineación perfecta gracias al anclaje entre cuerpo central y jets mediante perfiles.





Ref:

PARA 3 VÍAS

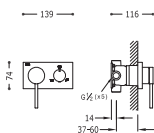

Monomando empotrar 3V

- Cuerpo empotrado incluido (3 vías).
 * NOTA: Es obligatorio añadir en el pedido un rociador, ducha de mano, jets o un caño bañera, dependiendo del tipo de instalación.

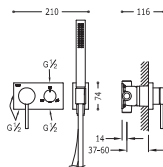

Monomando empotrar 3V

- Cuerpo empotrado incluido (3 vías).
 - Ducha móvil anticálrea (034.116.01).
 - Soporte con toma pared.
 - Flexo SATIN (91.34.609.15).
 * NOTA: Es obligatorio añadir en el pedido un rociador, ducha de mano, jets o un caño bañera, dependiendo del tipo de instalación.

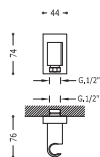

Soporte para ducha

con toma de agua a pared y válvula antirretorno.





Monomando empotrar 3V

- Cuerpo empotrado incluido (3 vías).
- Rociador ducha INOX a pared con 2 tipos de chorro. 280x550 mm (299.903.01).
- Soporte con toma pared.
- Ducha móvil anticalcárea (034.116.01).
- Flexo SATIN (91.34.609.15).

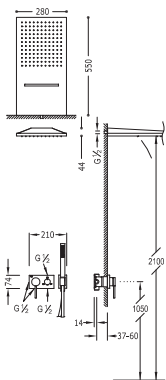

Cr | 210.273.01



N



Monomando empotrar 3V

- Cuerpo empotrado incluido (3 vías).
- Rociador ducha INOX a pared con 2 tipos de chorro. 280x550 mm.
- Soporte con toma pared.
- Ducha móvil anticalcárea.
- Flexo.

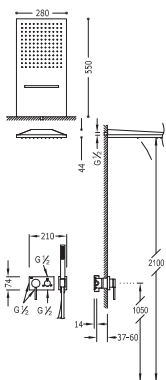

AC | 210.273.01.AC
 NM | 210.273.01.NM
 BM | 210.273.01.BM



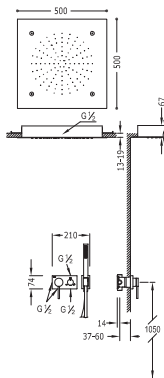

Monomando empotrar 3V

- Cuerpo empotrado incluido (3 vías).
- Rociador ducha INOX a techo 500x500 mm, 2 funciones (299.954.01).
- Soporte con toma pared.
- Ducha móvil anticalcárea (034.116.01).
- Flexo SATIN (91.34.609.15).

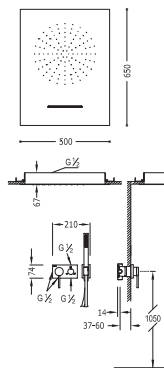

Monomando empotrar 3V

- Cuerpo empotrado incluido (3 vías).
- Rociador ducha INOX a techo con cascada 500x650 mm, 2 funciones (299.970.01).
- Soporte con toma pared.
- Ducha móvil anticalcárea (034.116.01).
- Flexo SATIN (91.34.609.15).





Monomando empotrar 3V

- Cuerpo empotrado incluido (3 vías).
- Ducha fija Ø 300 mm. con rótula. Material Latón (1.34.137.30).
- 3 jets antical (299.515.06).
- Soporte con toma pared.
- Ducha móvil anticalcárea (034.116.01).
- Flexo SATIN (91.34.609.15).

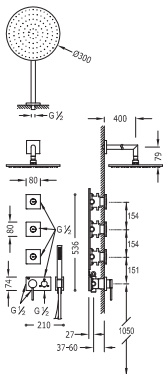

299.198.02 **RELOJERÍA**

Cr | **210.273.04**



Monomando empotrar 3V

- Cuerpo empotrado incluido (3 vías).
- Rociador ducha INOX a pared 160x550 mm. (299.903.03).
- 3 jets antical (299.515.06).
- Soporte con toma pared.
- Ducha móvil anticalcárea (034.116.01).
- Flexo SATIN (91.34.609.15).

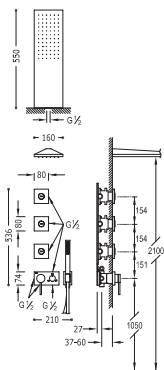

299.198.02 **RELOJERÍA**

Cr | **210.273.05**



Monomando empotrar 3V con CROMOTERAPIA

- Cuerpo empotrado incluido (3 vías).
- Rociador ducha INOX a techo 500x500 mm. 2 funciones (299.962.01).
- 3 jets antical (299.515.06).
- Soporte con toma pared.
- Ducha móvil anticalcárea (034.116.01).
- Flexo SATIN (91.34.609.15).



Monomando empotrar 3V

- Cuerpo empotrado incluido (3 vías).
- Rociador ducha INOX a techo 380x380 mm. (299.953.01).
- 3 jets antical (299.515.06).
- Soporte con toma pared.
- Ducha móvil anticalcárea (034.116.01).
- Flexo SATIN (91.34.609.15).





Monomando empotrar 3V con CROMOTERAPIA

- Cuerpo empotrado incluido (3 vías).
- Rociador ducha INOX a techo 500x500 mm. 2 funciones (299.962.01).
- Caño bañera.
- Soporte con toma pared.
- Ducha móvil anticalcárea (034.116.01).
- Flexo SATIN (91.34.609.15).



Cr | 210.273.06



Monomando empotrar 3V con CROMOTERAPIA

- Cuerpo empotrado incluido (3 vías).
- Rociador ducha INOX a techo 500x500 mm. 2 funciones (299.962.01).
- Desagüe para bañera con sistema de llenado tipo CASCADA y rebosadero (1.34.534.30).
- Sifón PVC bañera (1.34.634.60).
- Soporte con toma pared.
- Ducha móvil anticalcárea (034.116.01).
- Flexo SATIN (91.34.609.15).



Cr | 210.273.07



**Monomando empotrar 3V**

- Cuerpo empotrado incluido (3 vías).
- Rociador ducha INOX a techo Ø 380 mm. (1.34.940).
- Desagüe para bañera con sistema de llenado tipo CASCADA y rebosadero (1.34.534.30).
- Sifón PVC bañera (1.34.634.60).
- Soporte con toma pared.
- Ducha móvil anticalcárea (034.116.01).
- Flexo SATIN (91.34.609.15).



299.198.02

Cr | 210.273.10

**Monomando empotrar 3V**

- Cuerpo empotrado incluido (3 vías).
- Rociador ducha INOX a techo Ø 380 mm. (1.34.940).
- Caño bañera.
- Soporte con toma pared.
- Ducha móvil anticalcárea (034.116.01).
- Flexo SATIN (91.34.609.15).



299.198.02

Cr | 210.273.11



Monomando empotrar 3V

- Cuerpo empotrado incluido (3 vías).
- Rociador ducha INOX a techo Ø 380 mm.
- Caño bañera.
- Soporte con toma pared.
- Ducha móvil anticalcárea.
- Flexo.

	299.198.02	
AC	210.273.11.AC	
NM	210.273.11.NM	
BM	210.273.11.BM	



Monomando empotrar 3V

- Cuerpo empotrado incluido (3 vías).
- Rociador ducha INOX a pared 160x550 mm. (299.903.03).
- Desagüe para bañera con sistema de llenado tipo CASCADA y rebosadero (1.34.534.30).
- Sifón PVC bañera (1.34.634.60).
- Soporte con toma pared.
- Ducha móvil anticalcárea (034.116.01).
- Flexo SATIN (91.34.609.15).

	299.198.02	
Cr	210.273.12	



**Monomando empotrar 3V**

- Cuerpo empotrado incluido (3 vías).
- Ducha fija Ø 300 mm. con rótula. Material Latón (1.34.137.30).
- Caño bañera.
- Soporte con toma pared.
- Ducha móvil anticalcárea (034.116.01).
- Flexo SATIN (91.34.609.15).



299.198.02

Cr 210.273.13

**Monomando empotrar 3V**

- Cuerpo empotrado incluido (3 vías).
- Ducha fija Ø 300 mm. con rótula. Material Latón.
- Caño bañera.
- Soporte con toma pared.
- Ducha móvil anticalcárea.
- Flexo.



299.198.02

Ac 210.273.13.AC

NM 210.273.13.NM

BM 210.273.13.BM



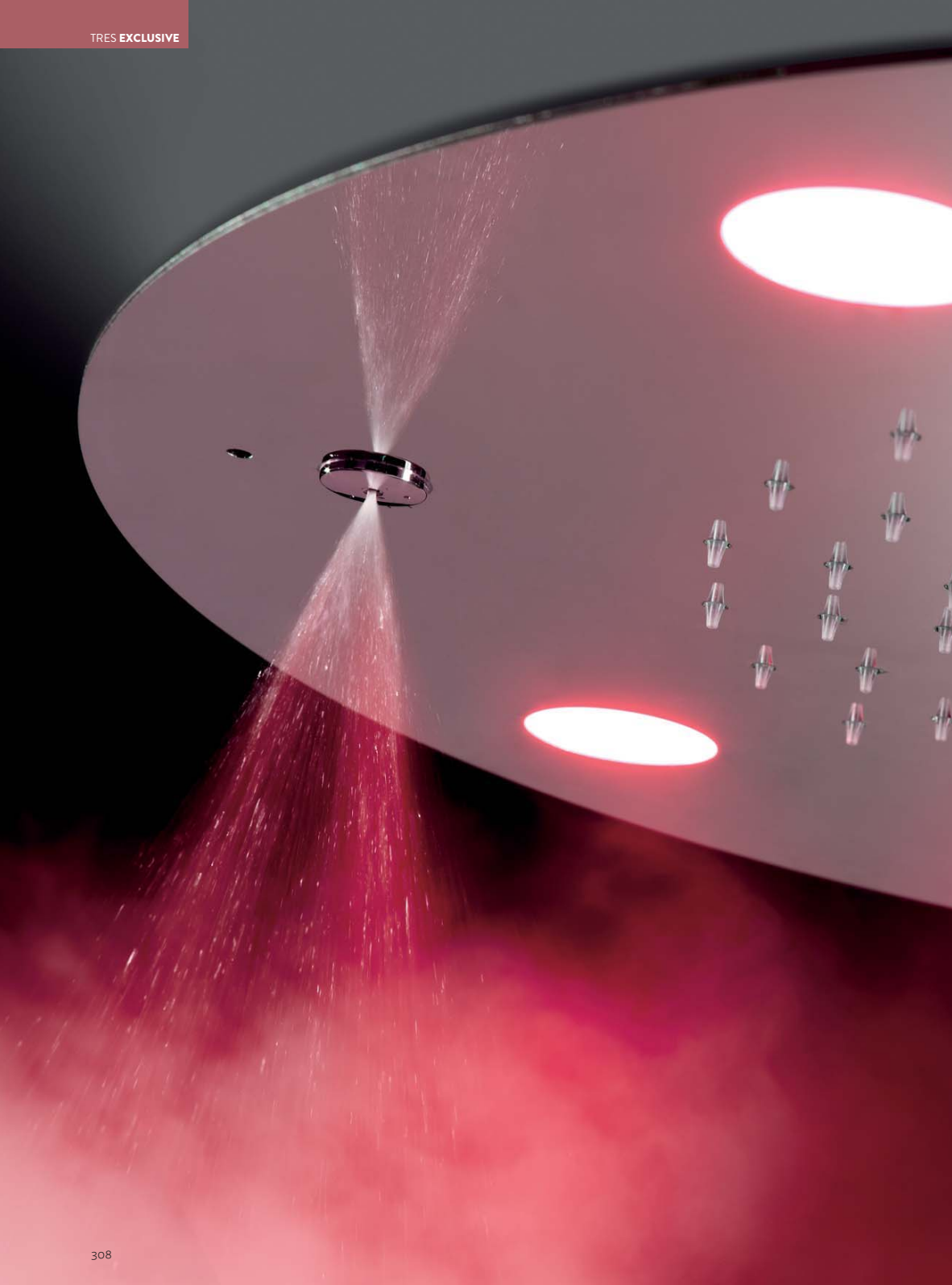

TRES EXCLUSIVE

PROGRAMA DE DUCHAS

- 312 Rociadores
- 332 Barras deslizantes
- 333 Duchas de mano
- 336 Jets
- 337 Soportes con toma pared y orientables



RECAMBIOS DE LOS ARTÍCULOS EN:
www.tresgriferia.com

UNA EXPERIENCIA NUEVA EN LA DUCHA

ROCIADORES DE GRAN FORMATO

Rociadores de techo empotrados, extraplanos.

Fabricados en acero inoxidable.

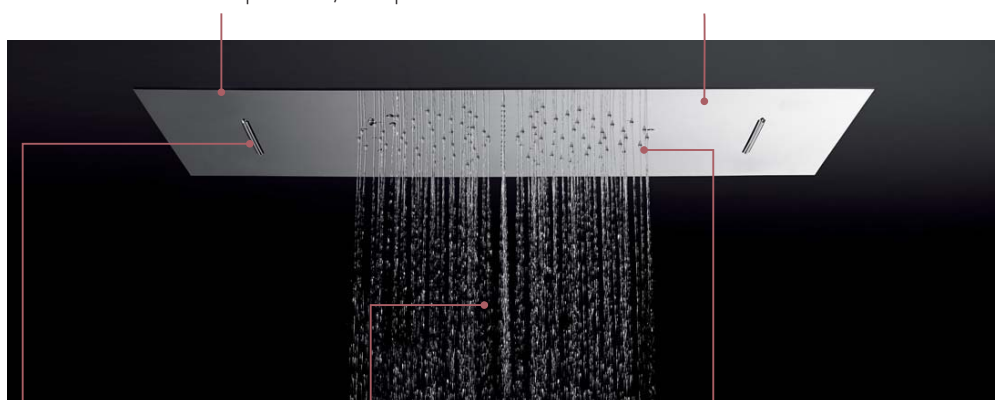

Salidas de agua combinadas:
Lluvia, cascada, micro drop.

Efecto envolvente gracias a la
distribución de chorros y los
limitadores de caudal.

Boquillas de silicona antical
que facilitan su limpieza.

TIPOS DE CHORRO



Cascada o doble cascada.



Efecto lluvia.



Micro drop. Dispersa el
agua en forma de gotas
minúsculas.

CROMOTERAPIA

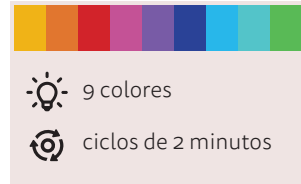

Los rociadores TRES Cromoterapia se basan en la combinación del agua con los colores, y ofrecen el mejor método de armonización basado en las propiedades revitalizantes de la luz, unidas al bienestar y el confort que nos entrega una ducha.

LAS REGLAS BÁSICAS DE LA CROMOTERAPIA

No causan daño. Cada matiz de color tiene carácter propio y emite vibraciones y fuerzas específicas.

Lo importante es que la persona se sienta bien con el color elegido.

El efecto energético no siempre es inmediato. El uso de los colores tarda en producir resultados tangibles. Y cuando se producen, a menudo no parecen guardar ninguna relación, y parecen ser el fruto natural del ir y venir de las cosas.

Requiere esfuerzos. El resultado depende absolutamente de tu predisposición personal, adoptando una actitud receptiva y dedicando tiempo a la ducha.

ACTIVACIÓN DE LAS LUCES LED

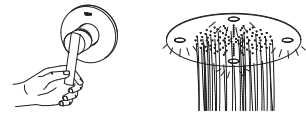

Las luces led se pueden activar de forma automática. Cuando se abre el grifo empieza el ciclo de luz.

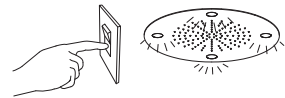

También se puede activar de forma manual si se instala el rociador para este fin; el ciclo de luz se activa a través de un interruptor externo (no suministrado) independientemente de si se abre el grifo o no.

ROCIADORES

Ref.:

Rociador ducha INOX a techo anticalcárea

Anticalcárea con 2 tipos de chorro (lluvia/cascada), 500x800 mm. Alimentación mediante 3 vías de agua independientes.

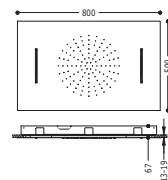
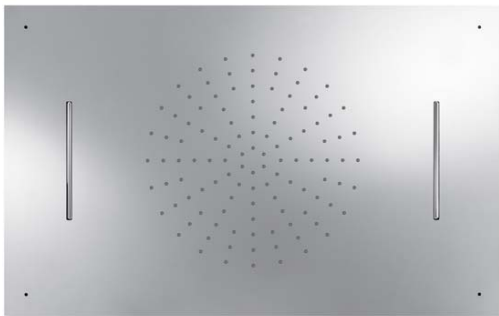

Cr 299.966.01

**Rociador ducha INOX a techo CROMOTERAPIA**

Anticalcárea con 2 tipos de chorro (lluvia/cascada), 500x800 mm. Alimentación mediante 3 vías de agua independientes. La luz, previa conexión a corriente, se activa manualmente mediante interruptor.

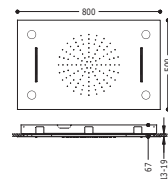
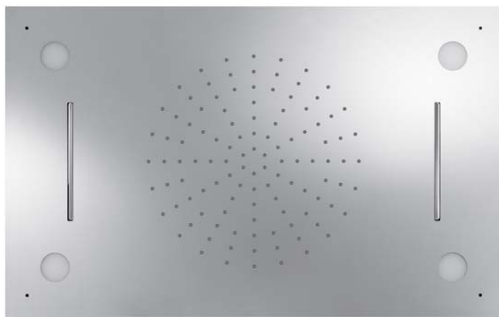

Cr 299.965.01

CROMOTERAPIA  

Rociador ducha INOX a techo anticalcárea

Anticalcárea con 2 tipos de chorro (luvia/cascada). 500x650 mm. Alimentación mediante 2 vías de agua independientes.

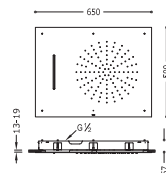
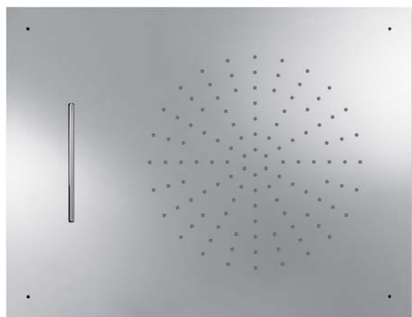

Cr | 299.970.01



Rociador ducha INOX a techo CROMOTERAPIA

Anticalcárea con 2 tipos de chorro (luvia/cascada). 500x650 mm. Alimentación mediante 2 vías de agua independientes. La luz, previa conexión a corriente, se activa manualmente mediante interruptor.

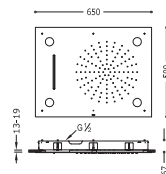
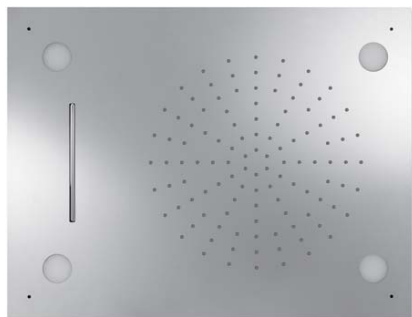

Cr | 299.972.01

CROMOTERAPIA



Rociador ducha INOX a techo anticalcárea

Anticalcárea con 3 tipos de chorro (lluvia/cascada/micro drop), 500x650 mm. Alimentación mediante 3 vías de agua independientes.

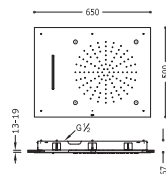
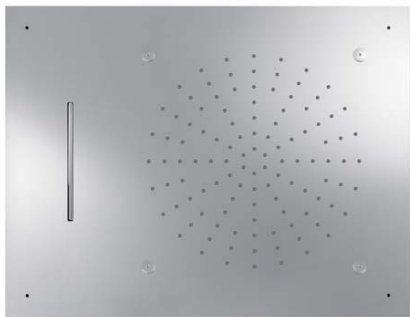

Cr 299.971.01



Rociador ducha INOX a techo CROMOTERAPIA

Anticalcárea, 500x500 mm. La luz, previa conexión a corriente, se enciende con el paso del agua, sin necesidad del interruptor.

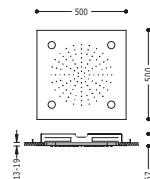
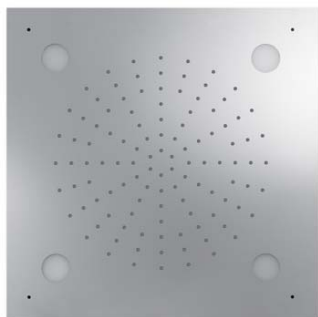

Cr 299.962.01



Rociador ducha INOX a techo anticalcárea

Anticalcárea con 2 tipos de chorro (lluvia/Micro drop). 500x500 mm. Alimentación mediante 2 vías de agua independientes.

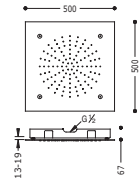
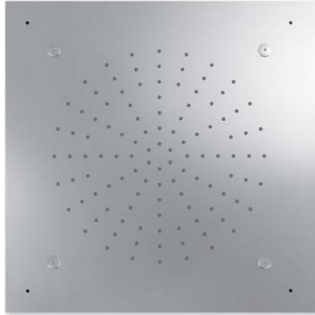

2 vías
Cr | 299.954.01



Rociador ducha INOX a techo anticalcárea

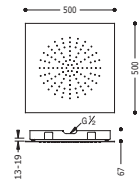
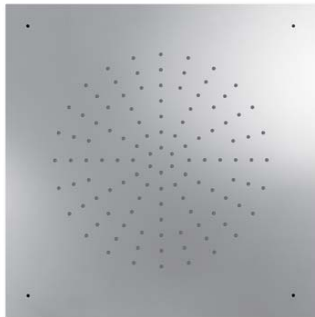

1 vía
Cr | 299.953.02

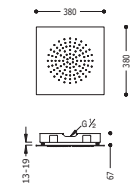

1 vía
Cr | 299.953.01



Rociador ducha INOX a techo LOFT
Anticalcárea con 2 tipos de chorro (luvia/cascada).

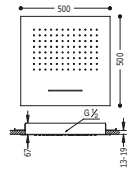
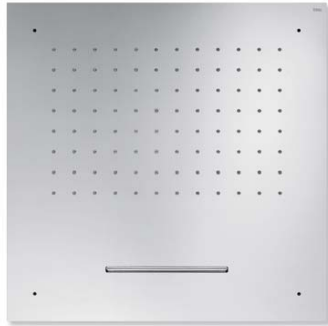

 20
  16
 2 vías

Cr **299.955.01**



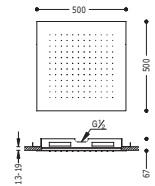
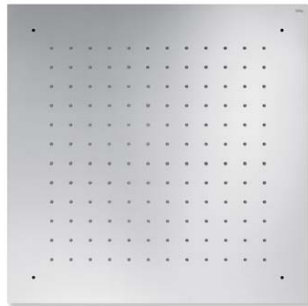

Rociador ducha INOX a techo anticalcárea

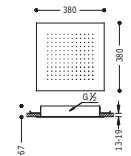

 24
 1 vía

Cr **1.34.951**



 20
 1 vía

Cr **1.34.944**



Rociador ducha INOX a techo anticalcárea
420x420 mm.

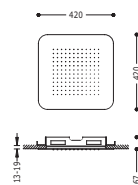

Cr | 299.516.07 |



Rociador ducha INOX a techo anticálrea

Anticálrea con 2 tipos de chorro (luvia/Micro drop). Ø 600 mm. Alimentación mediante 2 vías de agua independientes.

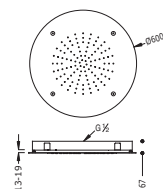
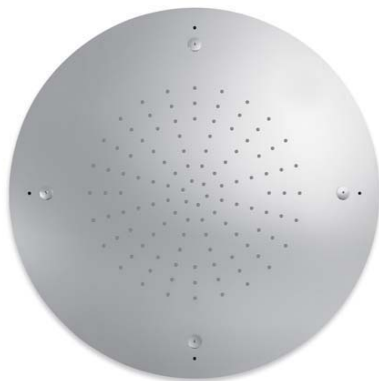

Cr 299.956.01

**Rociador ducha INOX a techo CROMOTERAPIA**

Anticálrea. Ø 600 mm. Alimentación mediante 1 vía de agua independiente. La luz, previa conexión a corriente, se activa con el paso del agua, sin necesidad del interruptor.

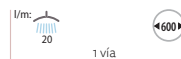
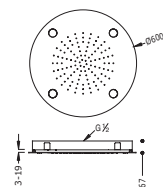
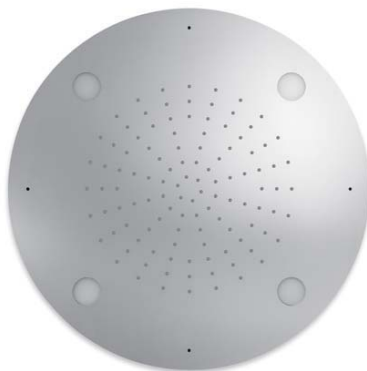

Cr 299.957.01



Rociador ducha INOX a techo CROMOTERAPIA

Anticalcárea con 2 tipos de chorro (lluvia/Micro drop), Ø 600 mm. Alimentación mediante 2 vías de agua independientes. La luz, previa conexión a corriente, se activa manualmente mediante interruptor.

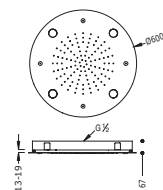

Cr | 299.958.01 |

CROMOTERAPIA



Rociador ducha INOX a techo anticalcárea

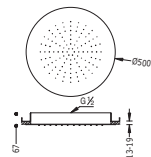
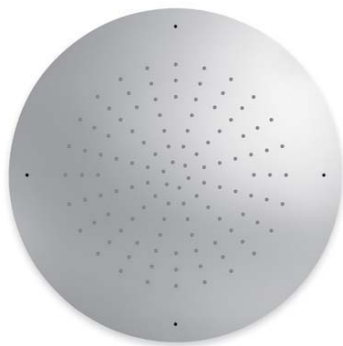

Cr | 1.34.950 |

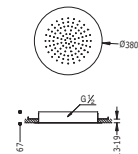

Cr | 1.34.940 |



Ref.:

Rociador ducha INOX a pared

Anticalcárea con 2 tipos de chorro (lluvia/cascada). 280x550 mm.

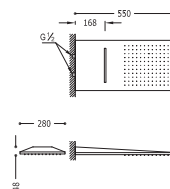

Rociador ducha INOX a pared

Anticalcárea. 210x550 mm.

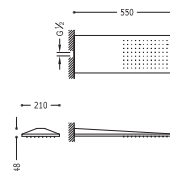

Rociador ducha INOX a pared

Anticalcárea. 160x550 mm.

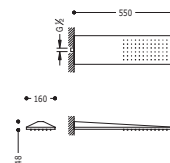

Rociador ducha INOX a pared

Anticalcárea con 2 tipos de chorro (lluvia/cascada), 280x550 mm.

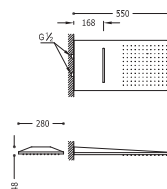

Rociador ducha INOX a pared

Anticalcárea. 210x550 mm.

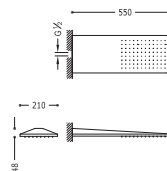

Rociador ducha INOX a pared

Anticalcárea. 160x550 mm.

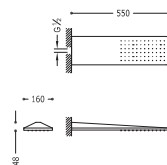

Rociador ducha a techo
Anticalcárea. Ø 330 mm.

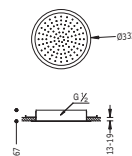

I/m	11	Ø 330
Cr	1.34.715	



Rociador ducha INOX a pared TRES-CONFORT
Anticalcárea con 2 tipos de chorro (lluvia/cascada).

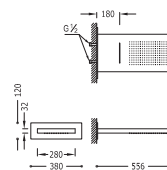

I/m	20	21	Ø 280	556
Cr	1.34.903	2 vías		



Rociador ducha a techo
Anticalcárea. 330x330 mm.

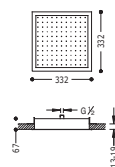

l/m:		11	
Cr	1.34.714		

Rociador ducha INOX a pared con cascada. 152x200 mm.

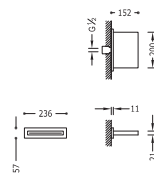

l/m:		16	
Cr	299.903.04		

1 vía

Rociador ducha anticálcarea

todo cromo 200x200 mm.

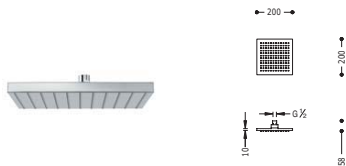

Rociador ducha anticálcarea FULL

todo cromo 250x250 mm.



Rociador ducha anticálcarea CUB-300

Latón 300x300 mm.

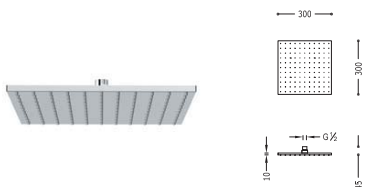

Rociador ducha anticálcarea LOFT-220

todo cromo 220x220 mm.

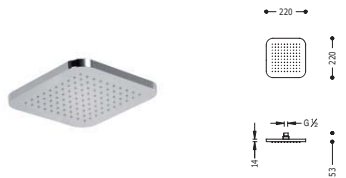

Rociador ducha anticálcarea

320x220 mm.

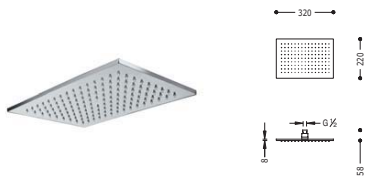

Rociador ducha anticálcarea

450x315 mm.

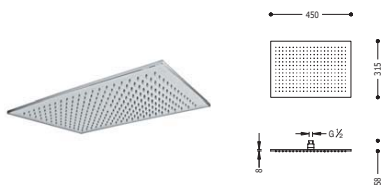

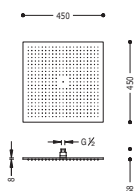

Rociador ducha anticalcárea
450x450 mm.

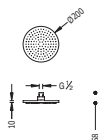

Rociador ducha anticalcárea
todo cromo Ø 200 mm.

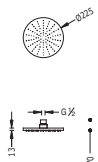

Rociador ducha anticalcárea LEX-225
todo cromo Ø 225 mm.

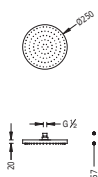

Rociador ducha anticalcárea FULL
todo cromo Ø 250 mm.

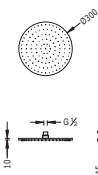

Rociador ducha anticalcárea MAX-300
Latón Ø 300 mm.

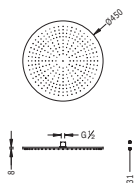

Rociador ducha anticalcárea
Ø 450 mm.



Ref.:

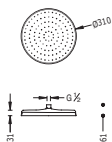

Rociador ducha anticalcárea CLASIC/RETRO
Ø 310 mm.



Cr	299.337.03
Lv	299.337.03.LV



Brazo pared
para rociador ducha long. 300 mm.

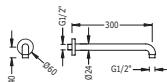

Cr	1.34.621.01
----	-------------

Brazo pared
para rociador ducha long. 400 mm.

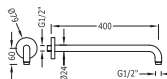

Cr	1.34.621.04
----	-------------

Brazo pared
para rociador ducha

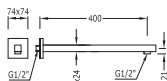

Cr	1.34.139.40
----	-------------

Brazo pared
para rociador ducha

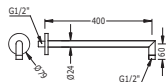

Cr	1.61.187.40
----	-------------

Brazo pared
para rociador ducha

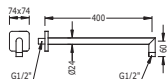

Cr	299.639.02
----	------------

Brazo pared
para rociador ducha



Cr | 062.432.01 |

Brazo techo
para rociador ducha

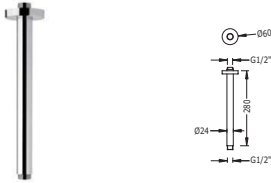

Cr | 1.34.621.02 |

Brazo techo
para rociador ducha



Cr | 1.34.521.02 |

Brazo techo
para rociador ducha

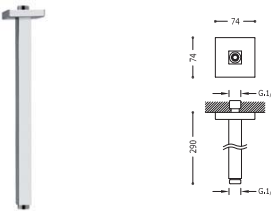

Cr | 1.34.622.02 |

Brazo techo
para rociador ducha

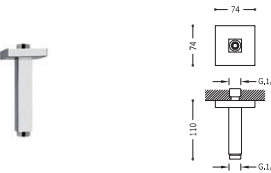

Cr | 1.34.522.02 |



Brazo de ducha a techo con rociador anticálcarea

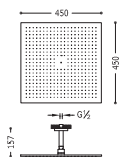
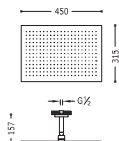
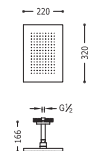
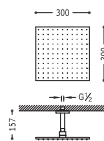
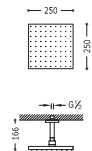



		 l/m: 1.34.221 ◀250▶
		 l/m: 1.34.331 ◀300▶
		 l/m: 299.432.04 ◀450▶

DUCHAS PARED

Ref.:

Brazo de ducha a pared con rociador anticalcárea

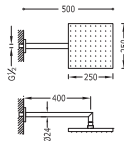

U/mc
11

Cr 034.231.01

250
250

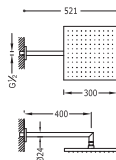

U/mc
11

Cr 034.431.01

300
300

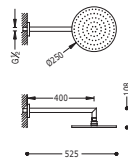

U/mc
11

Cr 1.34.232

4250

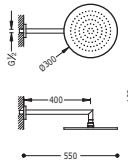

U/mc
11

Cr 1.34.432

300

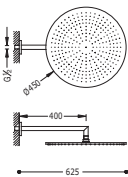

U/mc
15

Cr 299.532.04

4450

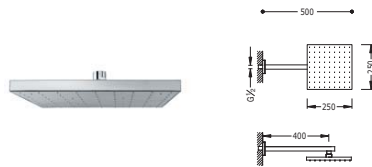

I/m:  11 
Cr | 1.34.233 |

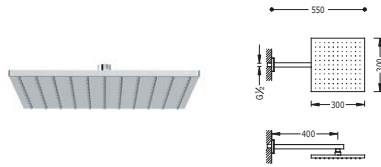

I/m:  11 
Cr | 1.34.433 |

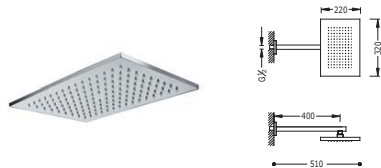

I/m:  12 
Cr | 299.532.02 |

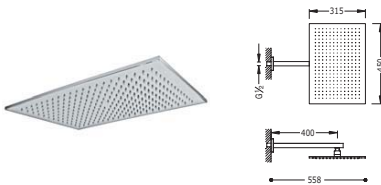

I/m:  14 
Cr | 299.532.03 |

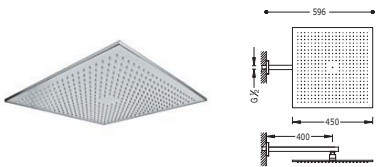

I/m:  16 
Cr | 299.532.05 |

BARRAS DESLIZANTES

Ref.:

Barra deslizante con toma de agua a pared
 Ø 14 mm. Long. 760 mm.

Barra deslizante con toma de agua a pared
 Ø 14 mm. Long. 760 mm.

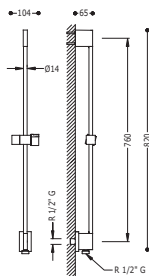

(760 mm.)
 Cr 034.932.99

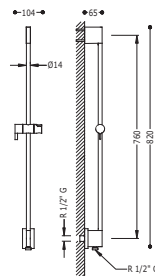

(760 mm.)
 Cr 034.931.99

Barra deslizante RETRO
 Ø 18 mm. long. 548 mm.

Barra deslizante
 Ø 20,6 mm. long. 600 mm.

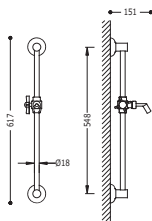

(548 mm.)
 Cr 1.34.732

Ac 5.34.732.03
 LV 5.34.732.01

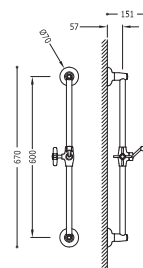

(600 mm.)
 Cr 242.732.01

Ac 242.732.01.AC
 LV 242.732.01.LV



Barra deslizante con toma de agua a pared

Ø 14 mm. Long. 760 mm. Ducha móvil anticalcárea. (202.639.01). Flexo.

Barra deslizante con toma de agua a pared

Ø 14 mm. Long. 760 mm. Ducha móvil anticalcárea. (034.116.01). Flexo.

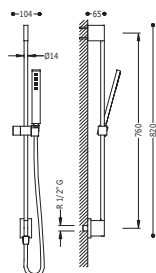

I/m: 9,5
(760 mm.)

Cr	034.932.01	
Ac	034.932.01.AC	N
NM	034.932.01.NM	N
BM	034.932.01.BM	N

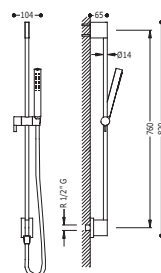

I/m: 9,5
(760 mm.)

Cr	034.931.01	
Ac	034.931.01.AC	N
NM	034.931.01.NM	N
BM	034.931.01.BM	N



DUCHAS

Ducha anticalcárea SLIM

Latón

Ducha anticalcárea CUADRO

Latón

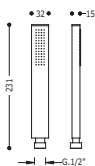

I/m: 9,5

Cr	202.639.01	
Ac	202.639.01.AC	

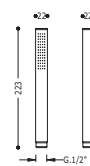

I/m: 9,5

Cr	006.639.01	
Ac	006.639.01.AC	
	006.639.01.NG	
	006.639.01.BL	



Ref.:

Ducha anticalcárea LOFT

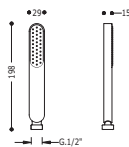

l/m: ρ 13

Cr	034.639.01
Ac	034.639.01.AC
Am	034.639.01.AM
Na	034.639.01.NA
Ro	034.639.01.RO
Vi	034.639.01.VI
Fu	034.639.01.FU
Ve	034.639.01.VE
Ne	034.639.01.NE
Bl	034.639.01.BL

Ducha anticalcárea TUB
Latón

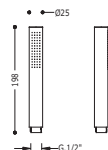

l/m: ρ 9.5

Cr	034.116.01
Ac	034.116.01.AC
Am	034.116.01.AM
Na	034.116.01.NA
Ro	034.116.01.RO
Vi	034.116.01.VI
Fu	034.116.01.FU
Ve	034.116.01.VE
Ne	034.116.01.NE
Bl	034.116.01.BL

Ducha masaje
5 tipos de chorro

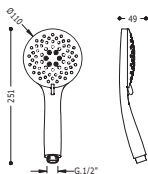

l/m: ρ ρ ρ ρ ρ 110

Cr	299.749.01
----	------------



Ducha masaje
3 tipos de chorro

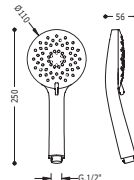

l/m: ρ ρ ρ 110

Cr	299.749.02
----	------------

Ducha masaje
3 tipos de chorro

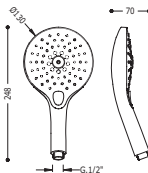

l/m: ρ ρ ρ 130

Cr	299.749.03
----	------------

Ducha masaje
3 tipos de chorro

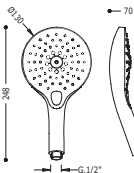

l/m: ρ ρ ρ 130

Bl-Cr	299.749.04
-------	------------

Ducha masaje
3 tipos de chorro

Ducha masaje
3 tipos de chorro

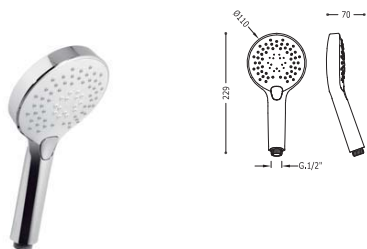

I/m: 8,8 9,6 8,8

Bl-Cr | 299.749.05

4110 ▶

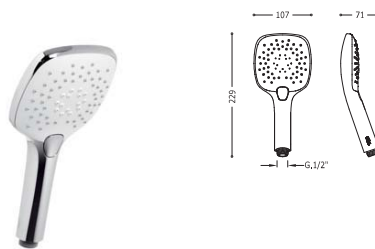

I/m: 8,2 8,6 8,1

Bl-Cr | 299.749.06

107 ▶
107

Ducha anticalcárea RETRO

Ducha anticalcárea



I/m: 13

Cr	1.24.824	
Ac	5.24.824.03	
Lv	5.24.824.01	

75 ▶



I/m: 15

Cr	91.34.824	
Ac	91.34.824.05.3	
Lv	91.34.824.05.1	

52 ▶

Ducha anticalcárea



I/m: 10

Cr	299.631.09	
Ac	299.631.09.AC	
Lv	299.631.09.LV	
Or	299.631.09.OR	

478 ▶



JETS

Ref.:

3 jets empotrados de hidromasaje
140x45 mm.

3 jets empotrados de hidromasaje
140x45 mm.

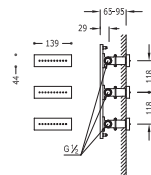

U/m: 7,9
Cr | 299.515.04

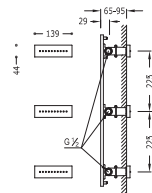

U/m: 7,9
Cr | 299.515.05

3 jets empotrados de hidromasaje
80x80 mm.

3 jets empotrados de hidromasaje
80x80 mm.

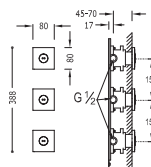

U/m: 10
Cr | 299.515.06

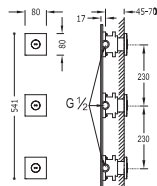

U/m: 10
Cr | 299.515.07

INSTALACIÓN RECOMENDADA

REF. 299.515.04
REF. 299.515.06

REF. 299.515.05
REF. 299.515.07

SOPORTES CON TOMA PARED

Ref.:

Soporte para ducha BLOCK SYSTEM

con toma de agua a pared regulable en profundidad, válvula antirretorno, cuerpo empotrado incluido y perfil de instalación.

Soporte para ducha

con toma de agua a pared y válvula antirretorno.

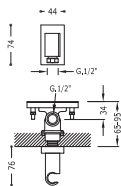

Cr | 207.182.02

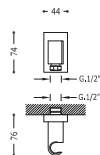

Cr | 207.182.01

Soporte para ducha

con toma pared

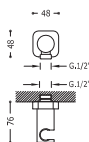

- | | |
|----|---------------|
| Ac | 200.182.01.AC |
| Am | 200.182.01.AM |
| Na | 200.182.01.NA |
| Ro | 200.182.01.RO |
| Vi | 200.182.01.VI |
| Fu | 200.182.01.FU |
| Ve | 200.182.01.VE |
| Ne | 200.182.01.NE |
| Bl | 200.182.01.BL |

SOPORTES ORIENTABLES

Soporte orientable redondo

Latón



- | | |
|----|---------------|
| Am | 061.839.01.AM |
| Na | 061.839.01.NA |
| Ro | 061.839.01.RO |
| Vi | 061.839.01.VI |
| Fu | 061.839.01.FU |
| Ve | 061.839.01.VE |
| Ne | 061.839.01.NE |
| Bl | 061.839.01.BL |

TRES EXCLUSIVE



TRÉS EXCLUSIVE

CONJUNTOS TERMOSTÁTICOS

340 Conjuntos termostáticos - (2 vías)

351 Conjuntos termostáticos - (3 vías)

355 Alargaderas



RECAMBIOS DE LOS ARTÍCULOS EN:
www.tresgriferia.com

ESPECIALISTAS EN CONJUNTOS TERMOSTÁTICOS

Con infinitas combinaciones posibles, siguiendo diseños redondos o cuadrados, tanto para la ducha como para la bañera, TRES se ha especializado en la fabricación de conjuntos de ducha, que otorgan presencia en el baño y permiten grandes momentos de relax bajo el agua. Con acabados de calidad y múltiples funciones para hacer de la ducha o el baño el momento preferido del día.

SEGURIDAD Y EFICIENCIA



TRES
TOUCH
COOL

El circuito interno del agua provoca que el agua fría sea la que toque con la superficie y de este modo el grifo siempre está frío al tacto, evitando quemaduras.

TRES
INSTANT
77

El cartucho garantiza un caudal de agua constante a la temperatura deseada de ± 1 grado ante variaciones de presión y/o temperatura.















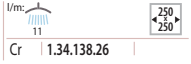









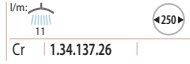
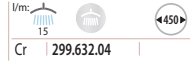











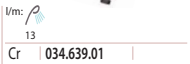
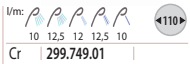

CALIDAD Y CONTROL TOTAL



- 1/** Gran variedad de rociadores de latón, con rótula orientable (22°).
- 2/** Barra telescópica que permite definir la altura del rociador, según cada necesidad.
- 3/** Duchas de mano con distintas funciones.
- 4/** Soporte orientable y con altura regulable.
- 5/** Inversor integrado en el volante regulador de caudal, tanto para 2 como para 3 vías.
- 6/** Control de temperatura con botón de seguridad que restringe la temperatura a 38°C.



CONJUNTOS PERSONALIZADOS

				
	 <p>l/m: 11 Cr 1.34.138.26</p>	 <p>l/m: 12 Cr 299.632.02</p>	 <p>l/m: 11 Cr 299.632.01</p>	 <p>l/m: 11 Cr 1.34.137.30</p>
+				
	 <p>l/m: 11 Cr 1.34.138.30</p>	 <p>l/m: 14 Cr 299.632.03</p>	 <p>l/m: 11 Cr 1.34.137.26</p>	 <p>l/m: 15 Cr 299.632.04</p>
				
	 <p>l/m: 9.5 Cr 202.639.01</p>	 <p>l/m: 9.5 Cr 006.639.01</p>	 <p>l/m: 8.2 8.6 8.1 Bl-Cr 299.749.06</p>	 <p>l/m: 7 8 5 Cr 299.749.03</p>
+				
	 <p>l/m: 9.5 Cr 034.116.01</p>	 <p>l/m: 13 Cr 034.639.01</p>	 <p>l/m: 10 12.5 12 12.5 10 Cr 299.749.01</p>	
				
	 <p>91.06.161.10 BELARBA Cr 007.495.01</p>	 <p>91.81.161.10 BELARBA Cr 090.495.01</p>	 <p>299.195.03 BELARBA Cr 205.495.01</p>	 <p>299.195.03 BELARBA Cr 081.495.01</p>

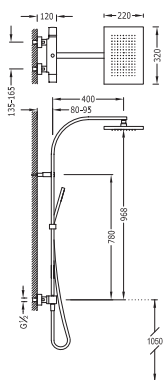

Conjunto ducha termostática

- Ducha fija 320x220 mm. con rótula. Material Latón (299.632.02).
- Ducha móvil anticalcárea (202.639.01)
- Flexo SATIN (91.34.609.15).
- Inversor integrado en el regulador de caudal.



	91.06.161.10
Cr	202.195.01

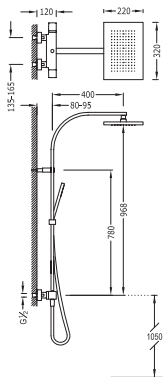

Conjunto ducha termostática

- Ducha fija 320x220 mm. con rótula. Material Latón.
- Ducha móvil anticalcárea.
- Flexo.
- Inversor integrado en el regulador de caudal.



	91.06.161.16
	91.06.161.14
	202.195.01.NE
	202.195.01.BL

N

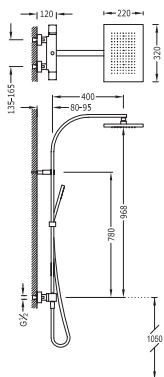

Conjunto ducha termostática

- Ducha fija 320x220 mm. con rótula. Material Latón.
- Ducha móvil anticalcárea.
- Flexo.
- Inversor integrado en el regulador de caudal.



	Ac	91.06.161.153
	NM	91.06.161.110/NM
	NM	91.06.161.110/BM
	Ac	202.195.01.AC
	NM	202.195.01.NM
	BM	202.195.01.BM

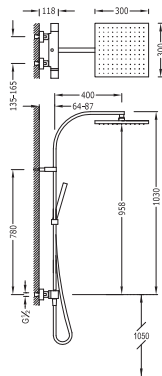

Conjunto ducha termostática

- Ducha fija 300x300 mm. con rótula. Material Latón (1.34.138.30).
- Ducha móvil anticalcárea (006.639.01).
- Flexo SATIN (91.34.609.15).
- Inversor integrado en el regulador de caudal.



91.06.161.10	91.06.161.10
Cr	1.07.395

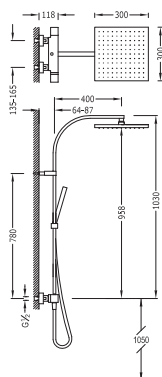

Conjunto ducha termostática

- Ducha fija 300x300 mm. con rótula. Material Latón.
- Ducha móvil anticalcárea.
- Flexo.
- Inversor integrado en el regulador de caudal.



91.06.161.16	91.06.161.14
■	■
6.07.395	6.07.395
■	■
4.07.395	4.07.395

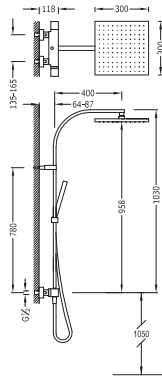

Conjunto ducha termostática

- Ducha fija 300x300 mm. con rótula. Material Latón.
- Ducha móvil anticalcárea.
- Flexo.
- Inversor integrado en el regulador de caudal.



Ac	91.06.161.53
NM	91.06.161.10.NM
BM	91.06.161.10.BM
AC	007.395.02.AC
NM	007.395.02.NM
BM	007.395.02.BM

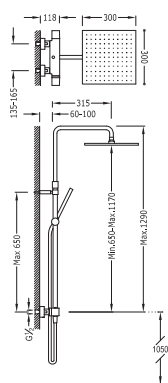

Conjunto ducha termostática

- Ducha fija 300x300 mm. con rótula. Material Latón (1.34.138.30).
- Ducha móvil anticalcárea (006.639.01).
- Flexo SATIN (91.34.609.15).
- Barra telescópica.
- Inversor integrado en el regulador de caudal.



91.06.161.10
Cr | 007.195.01

N

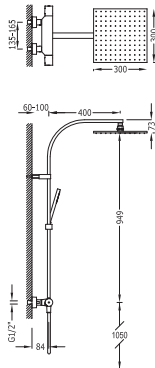

Conjunto ducha termostática

- Ducha fija 300x300 mm. con rótula. (1.34.138.30).
- Ducha móvil anticalcárea (202.639.01).
- Flexo SATIN (91.34.609.15).
- Inversor integrado en el regulador de caudal.



299.195.03
Cr | 211.395.01

N

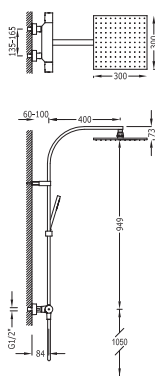

Conjunto ducha termostática

- Ducha fija 300x300 mm. con rótula.
- Ducha móvil anticalcárea.
- Flexo.
- Inversor integrado en el regulador de caudal.



299.195.03.AC
Ac | 211.395.01.AC

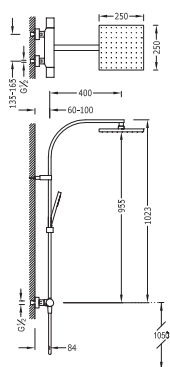

Conjunto ducha termostática

- Ducha fija 250x250 mm. con rótula. (1.34.138.26).
- Ducha móvil anticalcárea (299.631.08).
- Flexo SATIN (91.34.609.15).
- Inversor integrado en el regulador de caudal.



299.195.03 BELGARIA
Cr 205.395.01

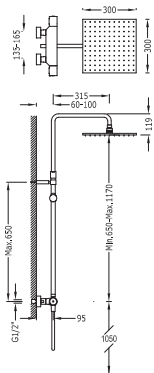

Conjunto ducha termostática

- Ducha fija 300x300 mm. con rótula. (1.34.138.30).
- Ducha móvil anticalcárea (202.639.01).
- Flexo SATIN (91.34.609.15).
- Barra telescópica.
- Inversor integrado en el regulador de caudal.



299.195.03
Cr 211.395.02

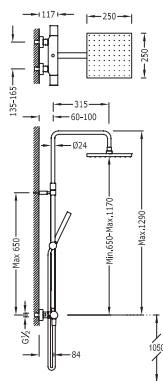

Conjunto ducha termostática

- Ducha fija 250x250 mm. con rótula. (1.34.138.26).
- Ducha móvil anticalcárea (299.631.08).
- Flexo SATIN (91.34.609.15).
- Barra telescópica.
- Inversor integrado en el regulador de caudal.



299.195.03 BELGARIA
Cr 205.385.01

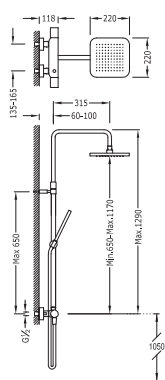

Conjunto ducha termostática

- Ducha fija 220x220 mm. con rótula. (299.632.06).
- Ducha móvil anticalcárea (034.639.01).
- Flexo SATIN (91.34.609.15).
- Barra telescópica.
- Inversor integrado en el regulador de caudal.



Cr | 200.195.01

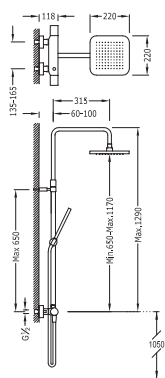

Conjunto ducha termostática

- Ducha fija 220x220 mm. con rótula. (299.632.06).
- Ducha móvil anticalcárea.
- Flexo.
- Barra telescópica.
- Inversor integrado en el regulador de caudal.

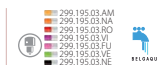

299.195.03.AM	200.195.01.AM
299.195.03.NA	200.195.01.NA
299.195.03.RO	200.195.01.RO
299.195.03.VI	200.195.01.VI
299.195.03.FU	200.195.01.FU
299.195.03.VE	200.195.01.VE
299.195.03.NE	200.195.01.NE
299.195.03.BL	200.195.01.BL

Conjunto ducha termostática

- Ducha fija 320x220 mm. con rótula. Material Latón (299.632.02).
- Ducha móvil anticalcárea (202.639.01).
- Flexo SATIN (91.34.609.15).

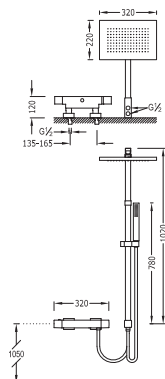

Cr | 202.385.01

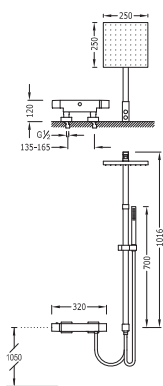

Conjunto ducha termostática

- Ducha fija 250x250 mm. con rótula. (1.34.138.26).
- Ducha móvil anticalcárea (006.639.01).
- Flexo SATIN (91.34.609.15).



91.06.161.10 BELGARA
Cr 007.385.01

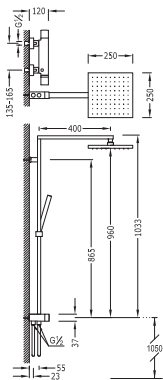

Conjunto ducha termostática

- Ducha fija 250x250 mm. con rótula. (1.34.138.26).
- Ducha móvil anticalcárea (006.639.01).
- Flexo SATIN (91.34.609.15).



91.06.161.10 BELGARA
Cr 1.07.964

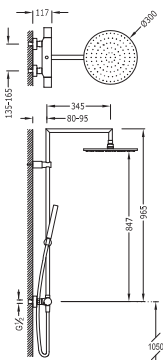

Conjunto ducha termostática

- Ducha fija Ø 300 mm. con rótula. (1.34.137.30). Material Latón.
- Ducha móvil anticalcárea (034.116.01).
- Flexo SATIN (91.34.609.15).
- Inversor integrado en el regulador de caudal.



299.195.03 BELGARA
Cr 061.393.01

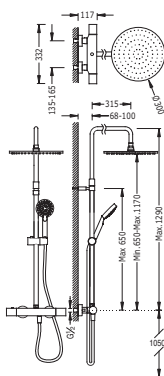

Conjunto ducha termostática

- Ducha fija Ø 300 mm. con rótula. Material Latón (1.34.137.30).
- Ducha móvil anticalcárea (299.748.02).
- Flexo SATIN (91.34.609.15).
- Barra telescópica.
- Inversor integrado en el regulador de caudal.



299.195.03
Cr | 061.210.01 |

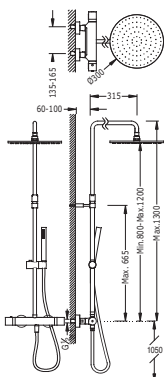

Conjunto ducha termostática

- Ducha fija Ø 300 mm. con rótula. Material Latón (1.34.137.30).
- Ducha móvil anticalcárea (034.116.01).
- Flexo SATIN (91.34.609.15).
- Barra telescópica.
- Inversor integrado en el regulador de caudal.



299.195.03
Cr | 261.210.01 |

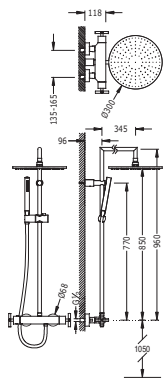

Conjunto ducha termostática

- Ducha fija Ø 300 mm. con rótula. Material Latón.
- Ducha móvil anticalcárea (034.116.01).
- Flexo SATIN (91.34.609.15).
- Inversor integrado en el regulador de caudal.



299.163.01
Cr | 063.393.01 |

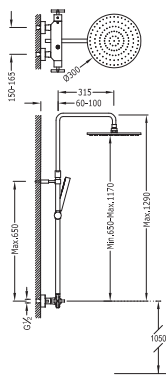

Conjunto ducha termostática

- Ducha fija Ø 300 mm. con rótula. (1.34.137.30). Material Latón.
- Ducha móvil anticalcárea (034.116.01).
- Flexo SATIN (91.34.609.15).
- Barra telescópica.
- Inversor integrado en el regulador de caudal.

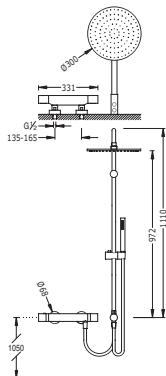

Conjunto ducha termostática

- Ducha fija Ø 300 mm. con rótula. Material Latón (1.34.137.30).
- Ducha móvil anticalcárea (034.116.01)
- Flexo SATIN (91.34.609.15).



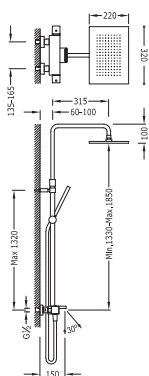

Conjunto bañera-ducha termostática

- Ducha fija 320x220 mm. con rótula. Material Latón (299.632.02).
- Ducha móvil anticalcárea (202.639.01).
- Flexo SATIN (91.34.609).
- Barra telescópica.



299.312.01 **Cr** | 202.312.01

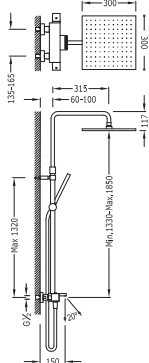

Conjunto bañera-ducha termostática

- Ducha fija 300x300 mm. con rótula. Material Latón (1.34.138.30).
- Ducha móvil anticalcárea (006.639.01).
- Flexo SATIN (91.34.609).
- Barra telescópica.



299.312.01 **Cr** | 007.312.01

N

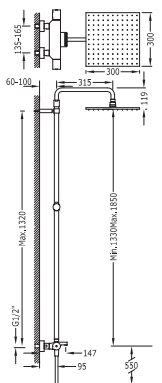

Conjunto bañera-ducha termostática

- Ducha fija 300x300 mm. con rótula. (1.34.138.30).
- Ducha móvil anticalcárea (202.639.01).
- Flexo SATIN (91.34.609).
- Barra telescópica.



299.195.03 **Cr** | 211.312.01

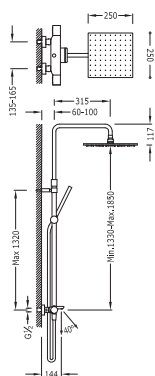

Conjunto bañera-ducha termostática

- Ducha fija 250x250 mm. con rótula. (1.34.138.26).
- Ducha móvil anticalcárea (299.631.08)
- Flexo SATIN (91.34.609).
- Barra telescópica.



299.195.03
Cr 205.312.01

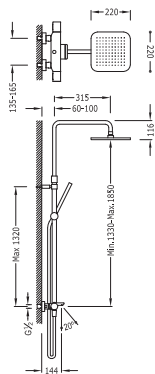

Conjunto bañera-ducha termostática

- Ducha fija 220x220 mm. con rótula. (299.632.06).
- Ducha móvil anticalcárea (034.639.01).
- Flexo SATIN (91.34.609).
- Barra telescópica.



299.195.03
Cr 200.312.01

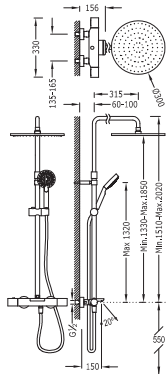

Conjunto bañera-ducha termostática

- Ducha fija Ø 300 mm. con rótula. Material Latón (1.34.137.30).
- Ducha móvil anticalcárea (299.748.02).
- Flexo SATIN (91.34.609).
- Barra telescópica.



299.195.03
Cr 062.312.01

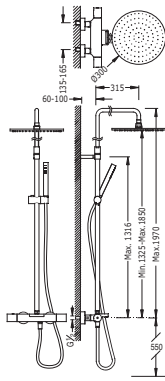

Conjunto bañera-ducha termostática

- Ducha fija Ø 300 mm. con rótula. Material Latón (1.34.137.30).
- Ducha móvil anticalcárea (034.116.01).
- Flexo SATIN (91.34.609).
- Barra telescópica.

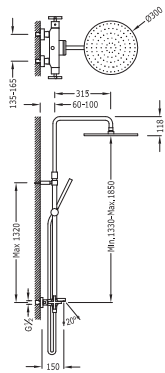

Conjunto bañera-ducha termostática

- Ducha fija Ø 300 mm. con rótula. Material Latón (1.34.137.30).
- Ducha móvil anticalcárea (034.116.01).
- Flexo SATIN (91.34.609).
- Barra telescópica.

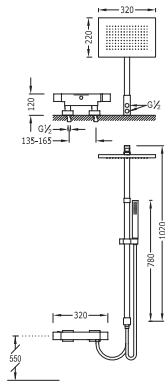

Conjunto bañera-ducha termostática

- Ducha fija 320x220 mm. con rótula. Material Latón (299.632.02).
- Ducha móvil anticalcárea (202.639.01).
- Flexo SATIN (91.34.609.15).



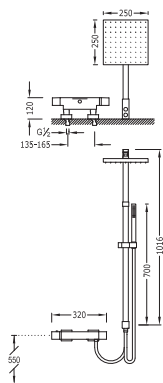

Conjunto bañera-ducha termostática

- Ducha fija 250x250 mm. con rótula. (1.34.138.26).
- Ducha móvil anticalcárea (006.639.01).
- Flexo SATIN (g1.34.609.15).



91.06.161.10
Cr 007.385.02

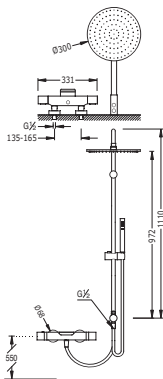

Conjunto bañera-ducha termostática

- Ducha fija Ø 300 mm. con rótula. Material Latón (1.34.137.30).
- Ducha móvil anticalcárea (034.116.01).
- Flexo SATIN (g1.34.609.15).



299.195.03
Cr 061.385.02

Alargaderas

Alargaderas

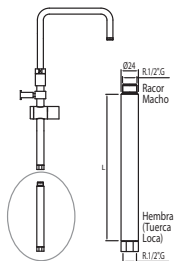

1 (para ref.: 024.164.04, 1.90.214, 205.385.01, 200.195.01, 1.90.213, 204.387.04, 242.195.02, 007.195.01, 090.495.01, 90.310, 90.311, 90.312, 90.210, 90.211, 90.212, 90.213, 90.214, 87.355, 87.356)

L= 300 mm.	Cr	91.81.195.03
L= 650 mm.	Cr	1.81.195.02

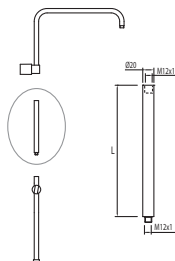

1 (para ref.: 012.995.01, 070.995.01, 081.192, 081.495.01, 1.81.191, 1.81.386, 1.81.385*, 203.191.01, 204.387.01, 081.193.01)

* posterior a mayo 2012

L= 300 mm.	Cr	91.81.385.03
L= 650 mm.	Cr	1.81.385.06

Alargaderas

Alargaderas

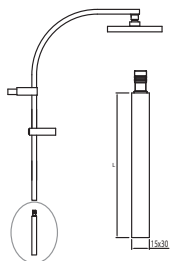

1 (para ref.: 1.07.395, 007.191.01, 204.395.01, 205.395.01)

L= 300 mm.	Cr	91.06.914.03
L= 500 mm.	Cr	1.06.914.05

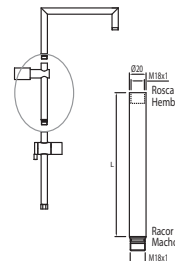

1 (para ref.: 90.481, 90.583, 90.281, 90.393)

L= 300 mm.	Cr	91.34.463.03
L= 650 mm.	Cr	1.34.463.02

Alargaderas

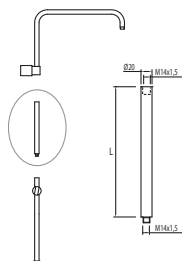

1 (para ref.: 90.385, 61.475, 1.81.385**)

** anterior a mayo 2012

L= 300 mm.	Cr	91.34.195.03
L= 650 mm.	Cr	1.34.195.02



TRES SELECTION

ESPACIO DUCHA - ESPACIO BAÑERA

- 358 Conjuntos termostáticos - (2 vías)
- 366 Conjuntos termostáticos - (3 vías)
- 368 Termostáticas de superficie
- 376 Columnas de ducha
- 380 Monomandos
- 396 Bañeras de repisa

RECAMBIOS DE LOS ARTÍCULOS EN:
www.tresgriferia.com

TERMOSTÁTICAS DE ÚLTIMA GENERACIÓN



COMPARACIÓN ENTRE UNA TERMOSTÁTICA CONVENCIONAL Y UNA TERMOSTÁTICA CON EL SISTEMA TOUCH-COOL®



Termostática convencional. El cartucho está en el volante derecho. El circuito interno del agua provoca que el agua caliente toque con la superficie y caliente el grifo.



Termostática con sistema touch-cool®. El cartucho está en el volante izquierdo. El circuito interno del agua provoca que el agua fría sea la que toque con la superficie y de este modo el grifo siempre está frío al tacto, evitando quemaduras.

La grifería termostática de TRES proporciona una temperatura constante del agua en el mínimo tiempo, reduciendo el consumo energético y de agua, e incorpora su sistema antiquemaduras touch-cool® (la grifería con este sistema se indica con el correspondiente símbolo).

VENTAJAS



Inversor integrado en el volante regulador de caudal, tanto para 2 como para 3 vías.



Cartucho distribuidor con tres funciones: llave de cierre, inversor y regulador de caudal.



Excéntricas con silenciador y filtro. Evita la entrada de suciedad, que se traduce en menos averías y una vida más larga.



Control de temperatura. Con botón de seguridad que restringe la temperatura a 38°C.



Fiabilidad del cartucho al ser un cuerpo totalmente anticálcico, insensible a las deposiciones de cal.

COMPARACIÓN DE CARTUCHOS (INTERCAMBIABLES)

TRES
INSTANT
57



Instant 57® 

Cartucho de difícil obstrucción, alta durabilidad y con protección anticálcica.

Caudal: 50-55 l/m

TRES
INSTANT
77



Instant 77® 

El cartucho garantiza un caudal de agua constante a la temperatura deseada de ± 1 grado ante variaciones de presión y/o temperatura. Concebido para la desinfección de la legionela.

Caudal: 30-35 l/m

LIMPIEZA FÁCIL DEL CARTUCHO

easy
CLEAN

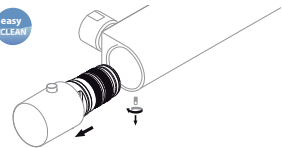

Con la tecnología easy clean®, TRES ofrece la posibilidad de limpiar fácilmente el cartucho en caso de obstrucción sin perder su calibración.

TERMOSTÁTICAS DE SUPERFICIE - (2 VÍAS)

Ref.:

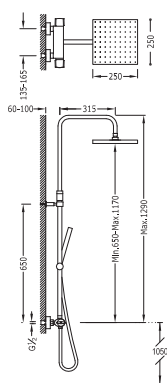

Conjunto ducha termostática

- Ducha fija 250x250 mm. con rótula. (1.34.138.26).
- Ducha móvil anticalcárea (006.639.01).
- Flexo SATIN (91.34.609.15).
- Barra telescópica.
- Inversor integrado en el regulador de caudal.



Cr 1.90.213

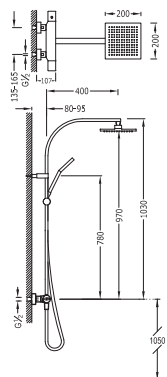

Conjunto ducha termostática

- Ducha fija 200x200 mm. con rótula.
- Ducha anticalcárea 80x80 mm. (1.34.612).
- Flexo SATIN (91.34.609.15).
- Inversor integrado en el regulador de caudal.



Cr 204.395.01

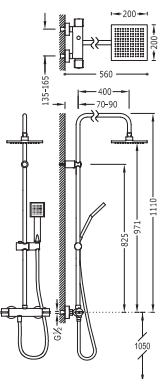

Conjunto ducha termostática

- Ducha fija 200x200 mm. con rótula.
- Ducha anticalcárea 80x80 mm. (1.34.612).
- Flexo SATIN (91.34.609.15).
- Inversor integrado en el regulador de caudal.



Cr 204.387.02

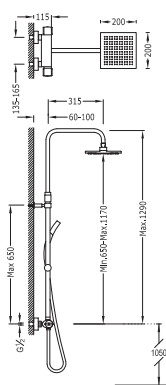

Conjunto ducha termostática

- Ducha fija 200x200 mm. con rótula.
- Ducha anticalcárea 80x80 mm. (1.34.612).
- Flexo SATIN (91.34.609.15).
- Barra telescópica.
- Inversor integrado en el regulador de caudal.



Cr | 204.387.04

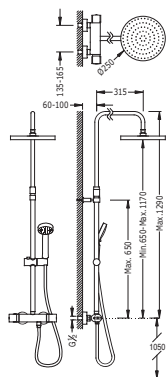

Conjunto ducha termostática

- Ducha fija Ø 250 mm. con rótula. (1.34.137.26).
- Ducha móvil masaje Ø 100 mm. (5 funciones) (1.34.748)
- Flexo SATIN (91.34.609.15).
- Barra telescópica.
- Inversor integrado en el regulador de caudal.



Cr | 1.90.214

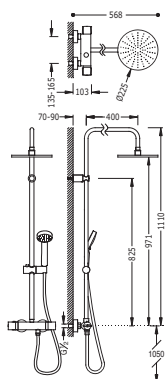

Conjunto ducha termostática

- Ducha fija Ø 225 mm. con rótula. (299.632.01).
- Ducha móvil masaje Ø 100 mm. (5 funciones) (1.34.748).
- Flexo SATIN (91.34.609.15).
- Inversor integrado en el regulador de caudal.



Cr | 1.81.385

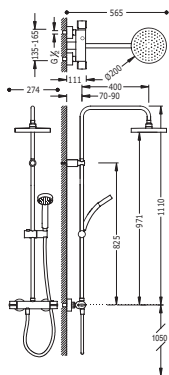

Conjunto ducha termostática

- Ducha fija Ø 200 mm. con rótula.
- Ducha anticalcárea Ø 80 mm. (1.34.617).
- Flexo SATIN (91.34.609.15).
- Inversor integrado en el regulador de caudal.



91.06.161.10 BELGARDIA
Cr 204.387.01

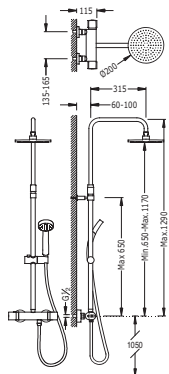

Conjunto ducha termostática

- Ducha fija Ø 200 mm. con rótula.
- Ducha anticalcárea Ø 80 mm. (1.34.617).
- Flexo SATIN (91.34.609.15).
- Barra telescópica.
- Inversor integrado en el regulador de caudal.



91.06.161.10 BELGARDIA
Cr 204.387.03

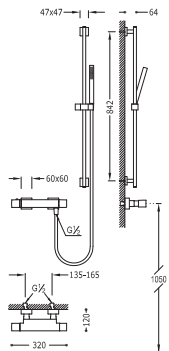

Kit de ducha termostático

- Barra deslizante long. 842 mm. (1.07.935).
- Ducha móvil anticalcárea (006.639.01).
- Flexo SATIN (91.34.609.15).



91.06.161.10 BELGARDIA
Cr 007.164.02

Kit de ducha termostático

- Barra deslizante long. 800 mm. (034.637.01).
- Ducha móvil anticalcárea (299.631.03).
- Flexo SATIN (91.34.609.15).

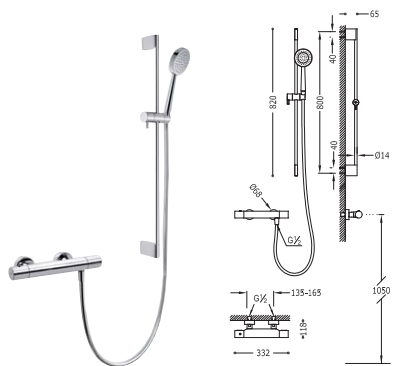

Kit de ducha termostático

- Barra deslizante Ø 20,6 mm. long. 673 mm. (034.637.06).
- Ducha anticalcárea Ø 80 mm. (1.34.617).
- Flexo doble engatillado (91.34.828).



Kit de ducha termostático

- Ducha móvil masaje.
- Barra deslizable PRACTIC-MAX.
- Ducha termostática.

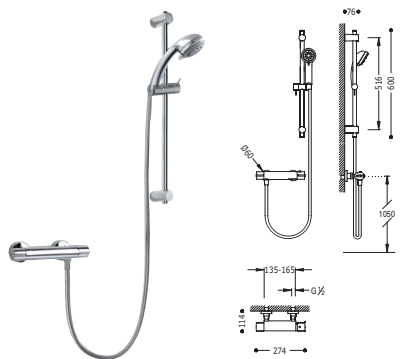

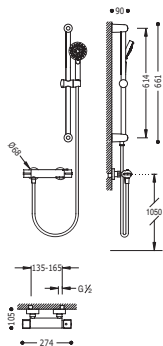

Kit de ducha termostática

- Barra deslizante ECO (Ø 25 mm, long 600 mm).
- Ducha móvil masaje Ø 100 mm. (5 posiciones).
- Flexo SATIN.



299.195.04
 BELGADIA
 Cr 090.186.02

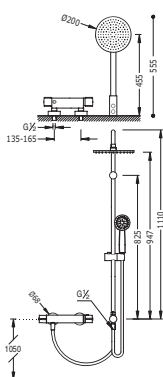

Conjunto ducha termostática

- Ducha fija Ø 200 mm, con rótula (299.632.12).
- Ducha anticálcarea Ø 80 mm. (1.34.617).
- Flexo SATIN (91.34.609.15).



299.195.08
 BELGADIA
 Cr 204.385.01

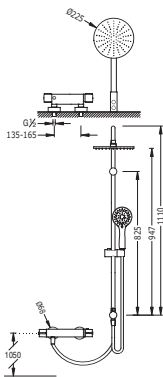

Conjunto ducha termostática

- Ducha fija Ø 225 mm, con rótula. (299.632.01).
- Ducha móvil masaje Ø 100 mm. (5 funciones) (1.34.748).
- Flexo SATIN (91.34.609.15).



299.195.04
 BELGADIA
 Cr 1.90.385

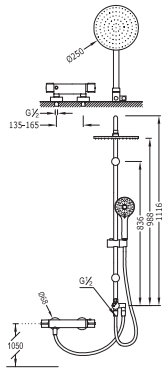

Conjunto ducha termostática

- Barra deslizante sobre sus soportes de pared.
- Ducha fija Ø 250 mm. con rótula (1.34.137.26).
- Ducha móvil masajé Ø 100 mm. (5 funciones).
- Flexo SATIN (91.34.609.15).

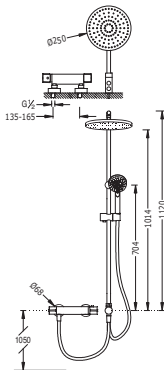

Conjunto ducha termostática

- Ducha fija Ø 250 mm. con rótula (1.34.137.26).
- Ducha móvil masajé Ø 100 mm. (5 funciones).
- Flexo SATIN (91.34.609.15).

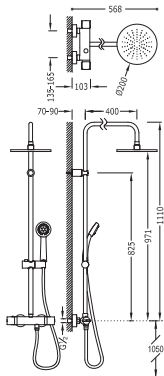

Conjunto ducha termostática

- Ducha fija Ø 200 mm. con rótula. (299.632.12).
- Ducha anticalcárea Ø 80 mm. (1.34.617).
- Flexo doble engatillado (91.34.828).
- Inversor integrado en el regulador de caudal.



TERMOSTÁTICAS DE SUPERFICIE - (3 VÍAS)

Ref.:

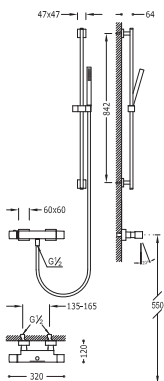

Kit de baño-ducha termostático

- Barra deslizante long. 842 mm. (1.07.935).
- Ducha móvil anticalcárea (006.639.01).
- Flexo SATIN (91.34.609).



91.06.161.10
 BEIGARUA
 Cr 007.174.02

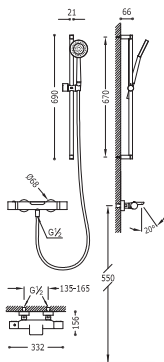

Kit de baño-ducha termostático

- Barra deslizante Ø 20,6 mm. long. 673 mm. (034.637.06).
- Ducha móvil anticalcárea (299.631.03).
- Flexo SATIN (91.34.609).



299.195.03
 BEIGARUA
 Cr 062.174.02

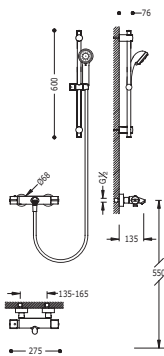

Kit de baño-ducha termostático

- Barra deslizante long. 516 mm. (1.61.835).
- Ducha masaje, 3 posiciones. (1.34.823).



91.94.161.10
 BEIGARUA
 Cr 1.83.398



TERMOSTÁTICAS DE SUPERFICIE

Ducha CUADRO termostática

(Ducha de mano anticalcárea (006.639.01) con soporte orientable y flexo SATIN (91.34.609.15)).



CUADRO

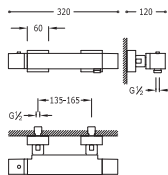

CUADRO	
Cr	1.07.164

CUADRO	
Cr	1.07.164.9

Ducha LOFT termostática

(Ducha de mano anticalcárea (034.639.01) con soporte orientable y flexo SATIN (91.34.609.15)).



LOFT

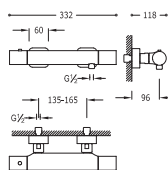

LOFT	
Cr	200.164.01

LOFT	
Cr	200.164.09

Ducha MAX termostática

(Ducha de mano anticalcárea con soporte orientable y flexo SATIN (91.34.609.15)).



CLASS

MAX

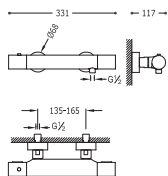

MAX/CLASS	
Cr	061.162.01

MAX	
Cr	061.162.09

CLASS	
Cr	205.164.01.9

Ducha LEX/ALPLUS termostática

(Ducha de mano masaje Ø 100 mm. (5 funciones) (1.34.748) con soporte orientable. Flexo SATIN (91.34.609.15)).



LEX/ALPLUS

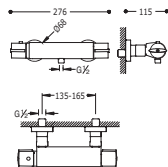

LEX/ALPLUS	
Cr	1.81.164

LEX/ALPLUS	
Cr	1.81.164.9

Ducha ECO-TERM termostática

(Ducha de mano anticalcárea (91.34.725) con soporte orientable y flexo SATIN (91.34.609.15)).

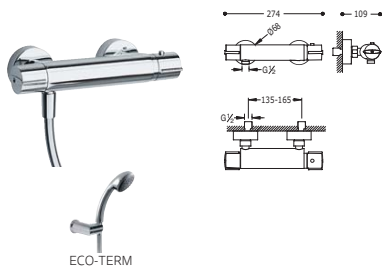

ECO-TERM
 299.195.04
 Cr | **1.90.186** |

ECO-TERM
 299.195.04
 Cr | **090.186.01** |



Ducha FLAT termostática

(Ducha de mano anticalcárea (1.34.617) con soporte orientable y flexo doble engatillado (91.34.828)).

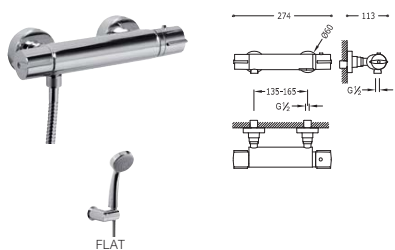

FLAT
 299.195.08
 Cr | **204.196.01** |

FLAT
 299.195.08
 Cr | **204.196.03** |



Ducha BASIC termostática

(Ducha de mano anticalcárea (1.34.821) con soporte orientable y flexo SATIN (91.34.609.15)).

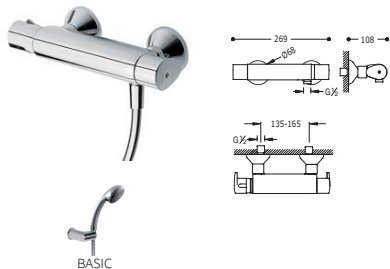

BASIC
 91.94.172
 Cr | **1.90.162** |

BASIC
 91.94.172
 Cr | **1.90.162.9** |



Ducha termostática

Ducha de mano anticalcárea (299.631.03) con soporte orientable y flexo SATIN (91.34.609.15). Indicado para personas con discapacidades físicas

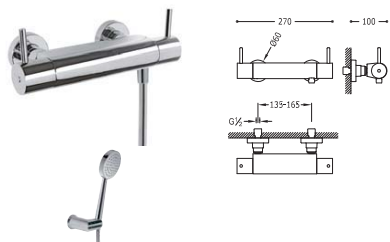

299.195.09
 Cr | **090.264.01** |

299.195.09
 Cr | **090.964.01** |



TERMOSTÁTICAS DE SUPERFICIE

Bañera- ducha CUADRO termostática

con cascada (Ducha de mano anticalcárea (006.639.01) con soporte orientable y flexo SATIN (91.34.609)).

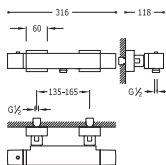

CUADRO



CUADRO			
Cr	91.06.161.10	BELGADA	
			1.07.174

CUADRO			
Cr	91.06.161.10	BELGADA	
			1.07.174.9

Bañera- ducha LOFT termostática

con cascada (Ducha de mano anticalcárea (034.639.01) con soporte orientable y flexo SATIN (91.34.609)).

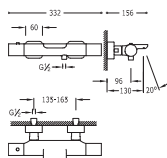

LOFT



LOFT			
Cr	299.195.03	ALBAHUK	
			200.174.01

LOFT			
Cr	299.195.03	BELGADA	
			200.174.09

Bañera- ducha MAX termostática

con cascada (Ducha de mano anticalcárea con soporte orientable y flexo SATIN (91.34.609)).

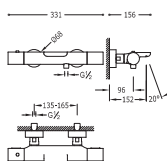

CLASS

MAX



MAX/CLASS			
Cr	299.195.03	BELGADA	
			061.172.01

MAX			
Cr	299.195.03	BELGADA	
			061.172.09

CLASS			
Cr	299.195.03	BELGADA	
			205.174.01.9

Bañera- ducha LEX/ALPLUS termostática

(Ducha móvil masaje Ø 100 mm. (5 funciones) (1.34.748) con soporte orientable y flexo SATIN (91.34.609)).

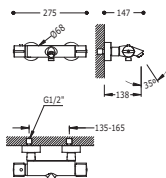

LEX/ALPLUS



LEX/ALPLUS			
Cr	91.81.161.10	BELGADA	
			1.81.174

LEX/ALPLUS			
Cr	91.81.161.10	BELGADA	
			1.81.174.9

Bañera-ducha BASIC termostática

(Ducha de mano anticalcárea (1.34.821) con soporte orientable y flexo SATIN (91.34.609)).

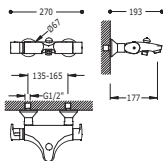

BASIC
91.94.172
Cr | 1.90.172



BASIC
91.94.172
Cr | 1.90.172.9

Bañera-ducha termostática

Ducha de mano anticalcárea (299.631.03) con soporte orientable y flexo SATIN (91.34.609). Indicado para personas con discapacidades físicas

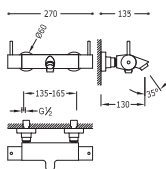

299.195.00
Cr | 090.274.01



299.195.09
Cr | 090.974.01

Codo adaptador baño-ducha

2 unidades con silenciador

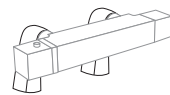
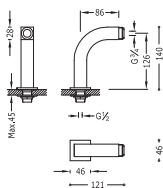

Cr | 299.870.02

Codo adaptador baño-ducha

2 unidades con silenciador

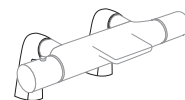
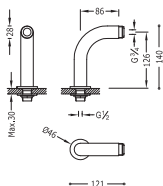

Cr | 299.870.01

Tomas de agua a suelo de bañera

2 unidades con soporte ducha giratorio

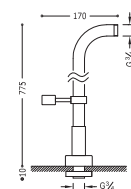

Cr | 1.61.194

TERMOSTÁTICA EMPOTRADA DE DISEÑO COMPACTO



FÁCIL MONTAJE Sin tornillos a la vista. Instalación óptima para tabiquería de pladur y de obra.

EMPOTRAMIENTO REGULABLE Entre 20 / 50 ó 60 mm de cuerpo empotrado. Solo se necesitan 60 mm de profundidad.

CONTROL DE TEMPERATURA Con botón de seguridad que restringe la temperatura a 38°C.

INVERSOR INTEGRADO Invierte la salida de agua entre la ducha de mano y la ducha mural o activa la doble función del rociador.

TERMOSTÁTICAS EMPOTRADAS (COMPACT)

Ref.:

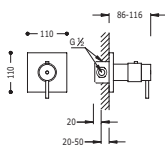

Termostática de empotrar ducha
con cierre y regulación de caudal.
- Cuerpo empotrado incluido

91.04.552
Cr | 1.90.647

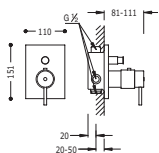

Termostática de empotrar baño-ducha
con cierre y regulación de caudal.
- Cuerpo empotrado incluido

91.04.552
Cr | 1.90.652

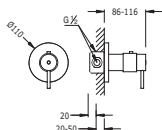

Termostática de empotrar ducha
con cierre y regulación de caudal.
- Cuerpo empotrado incluido

91.04.552
Cr | 1.90.547

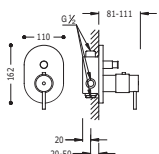

Termostática de empotrar baño-ducha
con cierre y regulación de caudal.
- Cuerpo empotrado incluido

91.04.552
Cr | 1.90.552

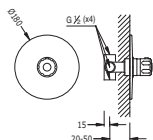

Termostática de empotrar ducha
Salidas de 1/2". Importante: Se debe añadir llave o llaves de paso para el cierre y regulación de caudal.
- Cuerpo empotrado incluido

91.04.290
Cr | 1.90.165

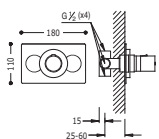

Termostática de empotrar ducha
Importante: Se debe añadir llave o llaves de paso para el cierre y regulación de caudal.
- Cuerpo empotrado incluido

91.04.161
Cr | 1.90.150

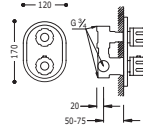

Termostática empotrar con llave de paso

- Salidas de 3/4". Gran caudal.
- Cuerpo empotrado incluido



N

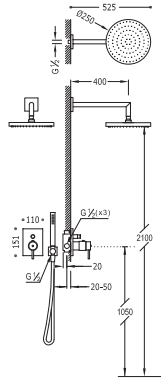

Kit de ducha termostático empotrado

- con cierre y regulación de caudal (2 vías).
- Cuerpo empotrado incluido
- Ducha fija Ø 250 mm. con rótula. Material Latón (1.34.137.26).
- Soporte con toma pared (061.182.01).
- Ducha móvil anticalcárea (034.116.01).
- Flexo SATIN (91.34.609.15).



N

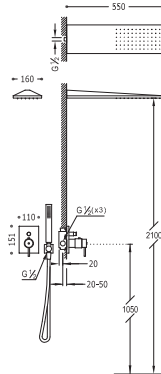

Kit de ducha termostático empotrado

- con cierre y regulación de caudal (2 vías).
- Cuerpo empotrado incluido
- Rociador ducha INOX a pared 160x550 mm. (299.903.03).
- Soporte con toma pared (061.182.01).
- Ducha móvil anticalcárea (299.631.08).
- Flexo SATIN (91.34.609.15).



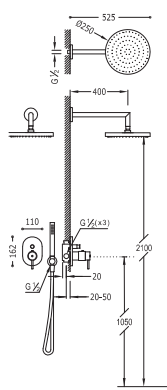

Kit de ducha termostático empotrado

con cierre y regulación de caudal (2 vías).

- Cuerpo empotrado incluido
- Ducha fija Ø 250 mm. con rótula. Material Latón (1.34.137.26).
- Soporte con toma pared (205.182.01).
- Ducha móvil anticalcárea (034.116.01).
- Flexo SATIN (91.34.609.15).



91.04.552

Cr | 090.960.22 |

COLUMNAS DE DUCHA





Rociador de gran formato

Consigue una ducha que te envuelva y estimule con una agradable sensación de lluvia.



Panel de Aluminio Anodizado

De fácil limpieza y máxima resistencia a la corrosión y al desgaste. No necesita mantenimiento.



Ducha de mano con funciones

Aumenta el poder tonificante y revitalizador del masaje por agua combinando los diferentes chorros.



Funciones simultáneas

Mandos independientes para cada función con cartucho termostático de respuesta inmediata.

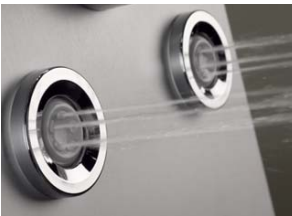

Jets orientables

Para un relajante masaje en cervicales, dorsales y lumbares.



Montaje en ducha o bañera

Ideal para llenar bañeras, refrescar los pies...



COLUMNAS DE DUCHA

Ref.:

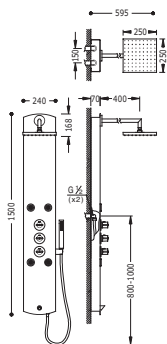

Columna de ducha termostática LEX-B

- Ducha fija 250x250 mm. con rótula. (1.34.138.26).
- Ducha móvil anticalcárea.
- Flexo SATIN (91.34.609.15).

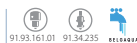

Anod | 1.93.124

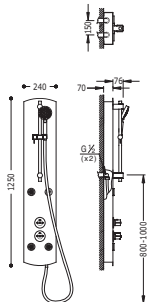

Columna de ducha termostática LEX-D

- Ducha móvil masaje.
- Flexo SATIN (91.34.609.15).



Anod | 1.93.223

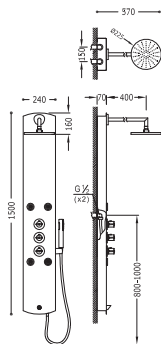

Columna de ducha termostática LEX-B

- Ducha fija Ø 225 mm. con rótula. (299.632.01).
- Ducha móvil anticalcárea.
- Flexo SATIN (91.34.609.15).



Anod | 1.93.123

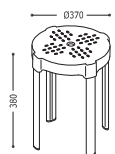

Taburete de baño
Peso máximo soportado 225 kg.



034.636.28

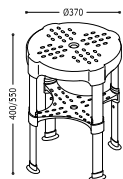

Taburete de baño ajustable
Peso máximo soportado 225 kg.



034.636.29

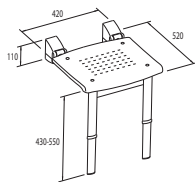

Asiento plegable de ducha con patas



034.636.30

MONOMANDOS PARA LA DUCHA



Diseño

Minimalistas y de estética moderna. Fáciles de limpiar.



Práctico

Un solo mando abre/cierra el paso del agua, ajusta la temperatura y regula el caudal.



Funcional

Invierte la salida de agua entre la ducha de mano y el rociador.



Duradero

Tanto por la calidad del material como por su robustez.



Ejemplo de un conjunto de superficie

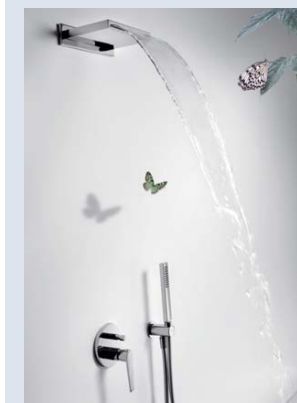

Ejemplo de un conjunto empotrado



MONOMANDOS DE SUPERFICIE

Ref.:

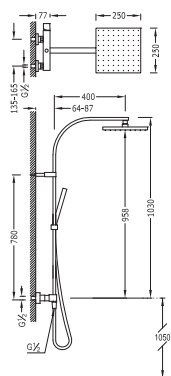

Conjunto ducha monomando anticalcárea CUADRO

- Ducha fija 250x250 mm. con rótula. (1.34.138.26).
- Ducha móvil anticalcárea (006.639.01).
- Flexo SATIN (91.34.609.15).

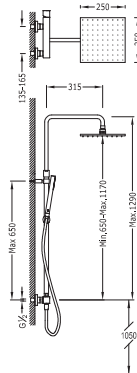

Conjunto ducha monomando anticalcárea CUADRO

- Ducha fija 250x250 mm. con rótula. (1.34.138.26).
- Ducha móvil anticalcárea (006.639.01).
- Flexo SATIN (91.34.609.15).
- Barra telescópica.

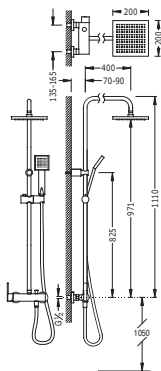

Conjunto ducha monomando anticalcárea LEX

- Ducha fija 200x200 mm. con rótula. (299.632.11).
- Ducha móvil anticalcárea (1.34.612).
- Flexo SATIN (91.34.609.15).



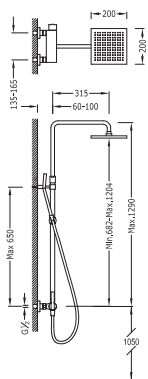

Conjunto ducha monomando anticalcárea LEX

- Ducha fija 200x200 mm. con rótula. (299.632.11).
- Ducha móvil anticalcárea (1.34.612).
- Flexo SATIN (91.34.609.15).
- Barra telescópica.

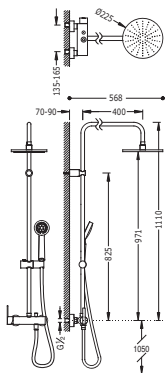

Conjunto ducha monomando anticalcárea LEX

- Ducha fija Ø 225 mm. con rótula. (299.632.01).
- Ducha móvil masaje Ø 100 mm. (5 funciones) (1.34.748).
- Flexo SATIN (91.34.609.15).

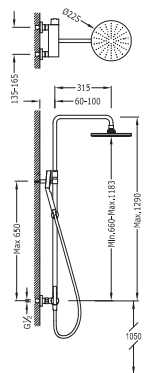

Conjunto ducha monomando anticalcárea LEX

- Ducha fija Ø 225 mm. con rótula. (299.632.01).
- Ducha móvil masaje Ø 100 mm. (5 funciones) (1.34.748).
- Flexo SATIN (91.34.609.15).
- Barra telescópica.



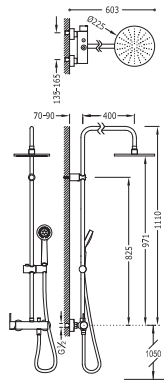

Conjunto ducha monomando anticalcárea ALPLUS

- Ducha fija Ø 225 mm. con rótula. (299.632.01).
- Ducha móvil anticalcárea (299.631.03).
- Flexo SATIN (91.34.609.15).

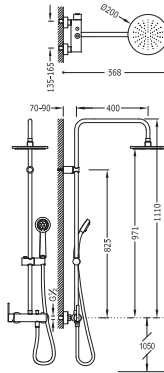

Conjunto ducha monomando anticalcárea LEX

- Ducha fija Ø 200 mm. con rótula. (299.632.12).
- Ducha anticalcárea Ø 80 mm. (1.34.617).
- Flexo doble engatillado (91.34.828).



EMPOTRADOS

Ref.: |

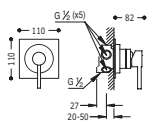

Distribuidor empotrado de 5 vías
con cierre y regulación de caudal (1 entrada y 5 salidas)

Cr | 1.34.550

MONOMANDOS EMPOTRADOS

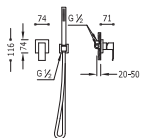

Kit de ducha monomando empotrado CUADRO

- con cierre y regulación de caudal.
- Cuerpo empotrado incluido
 - Soporte con toma pared (006.182.01).
 - Ducha móvil anticálcarea (006.639.01).
 - Flexo SATIN (91.34.609.15).

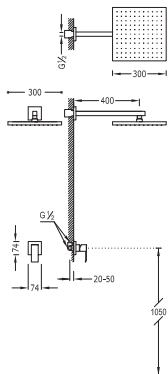

91.30.190
Cr | 006.177.03



Kit de ducha monomando empotrado CUADRO

- con cierre y regulación de caudal.
- Cuerpo empotrado incluido
 - Ducha fija 300x300 mm. con rótula. Material Latón. (1.34.138.30).

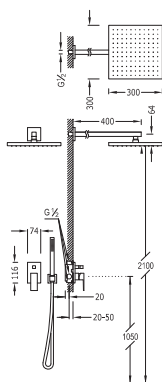
91.30.190
Cr | 1.06.377



Kit de ducha monomando empotrado CUADRO

- con cierre y regulación de caudal.
- Cuerpo empotrado incluido
- Ducha fija 300x300 mm. con rótula. Material Latón. (1.34.138.30).
- Soporte con toma pared (006.182.01).
- Ducha móvil anticalcárea (006.639.01).
- Flexo SATIN (91.34.609.15).



91.30.190 BELARUBA
Cr | 1.06.980

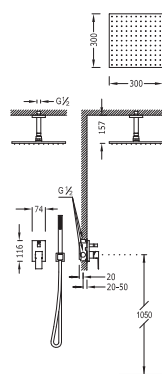

Kit de ducha monomando empotrado CUADRO

- con cierre y regulación de caudal.
- Cuerpo empotrado incluido
- Ducha fija 300x300 mm. con rótula. Material Latón. (1.34.138.30).
- Soporte con toma pared (006.182.01).
- Ducha móvil anticalcárea (006.639.01).
- Flexo SATIN (91.34.609.15).



91.30.190 BELARUBA
Cr | 006.180.80

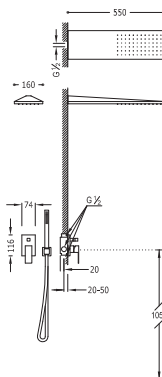

Kit de ducha monomando empotrado CUADRO

- con cierre y regulación de caudal.
- Cuerpo empotrado incluido
- Rociador ducha INOX a pared 160x550 mm. (299.903.03).
- Soporte con toma pared (006.182.01).
- Ducha móvil anticalcárea (006.639.01).
- Flexo SATIN (91.34.609.15).



91.30.190 BELARUBA
Cr | 006.180.80

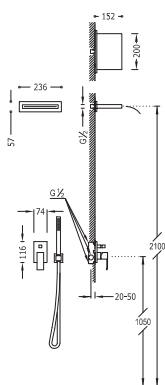

Kit de ducha monomando empotrado CUADRO

- con cierre y regulación de caudal.
- Cuerpo empotrado incluido
 - Ducha INOX con cascada 152x200 mm.
 - Soporte con toma pared (006.182.01).
 - Ducha móvil anticalcárea (006.639.01).
 - Flexo SATIN (91.34.609.15).



91.30.190 BELGARDIA
Cr | 006.180.06

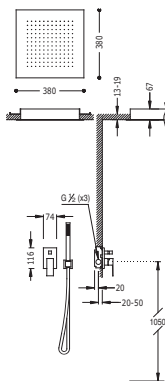

Kit de ducha monomando empotrado CUADRO

- con cierre y regulación de caudal.
- Cuerpo empotrado incluido
 - Rociador ducha INOX a techo 380x380 mm. (1.34.944).
 - Soporte con toma pared (006.182.01).
 - Ducha móvil anticalcárea (006.639.01).
 - Flexo SATIN (91.34.609.15).



91.30.190 BELGARDIA
Cr | 006.980.01

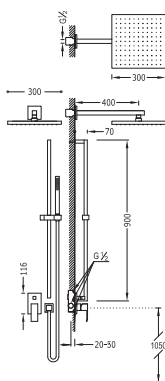

Kit de ducha monomando empotrado CUADRO

- con cierre y regulación de caudal.
- Cuerpo empotrado incluido
 - Ducha fija 300x300 mm. con rótula. Material Latón. (1.34.138.30).
 - Barra deslizante long. 900 mm. (1.07.935).
 - Codo toma pared (006.183.01).
 - Ducha móvil anticalcárea (006.639.01).
 - Flexo SATIN (91.34.609.15).



91.30.190 BELGARDIA
Cr | 1.06.985





Kit de ducha monomando empotrado MAX

- con cierre y regulación de caudal.
- Cuerpo empotrado incluido
- Soporte con toma pared (061.182.01).
- Ducha móvil anticalcárea (034.116.01).
- Flexo SATIN (91.34.609.15).

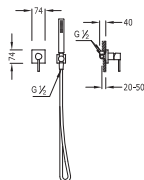

91.30.190
  BELGADUA
 Cr 062.177.03



Kit de ducha monomando empotrado MAX

- con cierre y regulación de caudal.
- Cuerpo empotrado incluido
- Ducha fija Ø 300 mm. con rótula. (1.34.137.30). Material Latón.
- Soporte con toma pared (061.182.01).
- Ducha móvil anticalcárea (034.116.01).
- Flexo SATIN (91.34.609.15).

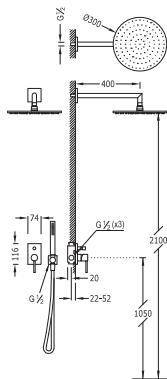

91.30.190
  BELGADUA
 Cr 062.980.01



Kit de ducha monomando empotrado MAX

- con cierre y regulación de caudal.
- Cuerpo empotrado incluido
- Ducha fija Ø 300 mm. con rótula. (1.34.137.30). Material Latón.
- Soporte con toma pared (061.182.01).
- Ducha móvil anticalcárea (034.116.01).
- Flexo SATIN (91.34.609.15).

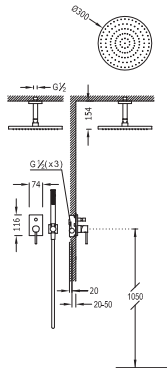

91.30.190
  BELGADUA
 Cr 062.180.80

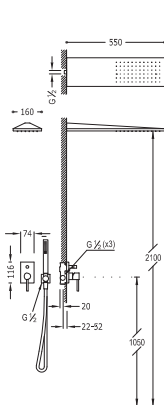

Kit de ducha monomando empotrado MAX

con cierre y regulación de caudal.

- Cuerpo empotrado incluido
- Rociador ducha INOX a pared 160x550 mm. (299.903.03).
- Soporte con toma pared (061.182.01).
- Ducha móvil anticalcárea (034.116.01).
- Flexo SATIN (91.34.609.15).



Cr | 062.516.01 |

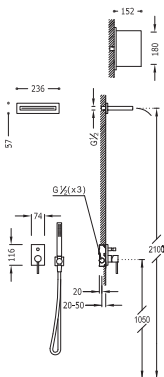

Kit de ducha monomando empotrado MAX

con cierre y regulación de caudal.

- Cuerpo empotrado incluido
- Ducha INOX con cascada 152x200 mm.
- Soporte con toma pared (061.182.01).
- Ducha móvil anticalcárea (034.116.01).
- Flexo SATIN (91.34.609.15).



Cr | 062.180.05 |

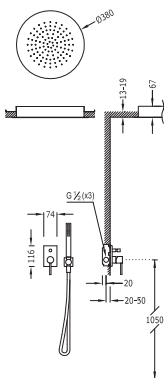

Kit de ducha monomando empotrado MAX

con cierre y regulación de caudal.

- Cuerpo empotrado incluido
- Rociador ducha INOX a techo Ø 380 mm. (1.34.940).
- Soporte con toma pared (061.182.01).
- Ducha móvil anticalcárea (034.116.01).
- Flexo SATIN (91.34.609.15).



Cr | 062.180.09 |



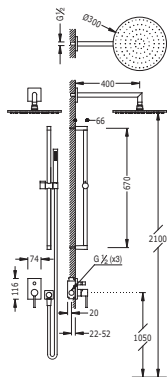

Kit de ducha monomando empotrado MAX

- con cierre y regulación de caudal.
- Cuerpo empotrado incluido
- Ducha fija Ø 300 mm. con rúta. Material Latón. (1.34.137.30).
- Barra deslizante long. 673 mm. (034.637.06).
- Codo toma pared (061.183.01).
- Ducha móvil anticalcárea (034.116.01).
- Flexo SATIN (91.34.609.15).



91.30.190 BELARUBIA
Cr 062.980.02

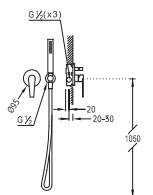

Kit de ducha monomando empotrado CLASS

- con cierre y regulación de caudal.
- Cuerpo empotrado incluido
- Soporte con toma pared (205.182.01).
- Ducha móvil anticalcárea (299.631.08).
- Flexo SATIN (91.34.609.15).

91.30.190 BELARUBIA
Cr 205.177.02

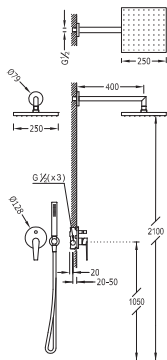

Kit de ducha monomando empotrado CLASS

- con cierre y regulación de caudal.
- Cuerpo empotrado incluido
- Ducha fija 250x250 mm. con rúta. (1.34.138.26).
- Soporte con toma pared (205.182.01).
- Ducha móvil anticalcárea (299.631.08).
- Flexo SATIN (91.34.609.15).

91.30.190 BELARUBIA
Cr 205.180.02

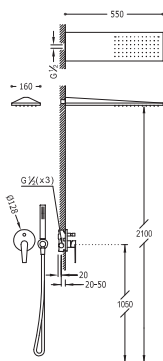

Kit de ducha monomando empotrado CLASS

con cierre y regulación de caudal.

- Cuerpo empotrado incluido
- Rociador ducha INOX a pared 160x550 mm. (299.903.03).
- Soporte con toma pared (205.182.01).
- Ducha móvil anticalcárea (299.631.08).
- Flexo SATIN (91.34.609.15).



91.30.190

Cr | 205.180.03

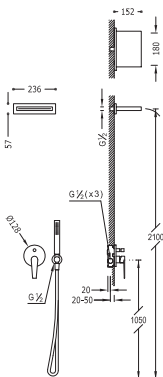

Kit de ducha monomando empotrado CLASS

con cierre y regulación de caudal.

- Cuerpo empotrado incluido
- Ducha INOX con cascada 152x200 mm.
- Soporte con toma pared (205.182.01).
- Ducha móvil anticalcárea (299.631.08).
- Flexo SATIN (91.34.609.15).



91.30.190

Cr | 205.180.04

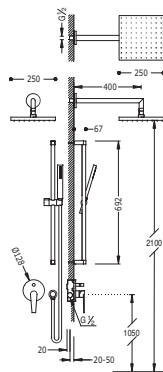

Kit de ducha monomando empotrado CLASS

con cierre y regulación de caudal.

- Cuerpo empotrado incluido
- Ducha fija 250x250 mm. con rótula. (1.34.138.26).
- Barra deslizante long. 673 mm. (034.637.06).
- Codo toma pared (1.34.757).
- Ducha móvil anticalcárea (299.631.08).
- Flexo SATIN (91.34.609.15).



91.30.190

Cr | 205.180.05





Kit de ducha monomando empotrado LOFT

- con cierre y regulación de caudal.
- Cuerpo empotrado incluido
- Soporte con toma pared (200.182.01).
- Ducha móvil anticalcárea (034.639.01).
- Flexo SATIN (91.34.609.15).

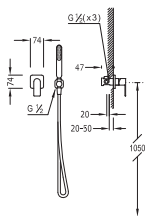

Kit de ducha monomando empotrado LOFT

- con cierre y regulación de caudal.
- Cuerpo empotrado incluido
- Ducha fija 220x220 mm. con rótula (299.632.06).
- Soporte con toma pared (200.182.01).
- Ducha móvil anticalcárea (034.639.01).
- Flexo SATIN (91.34.609.15).

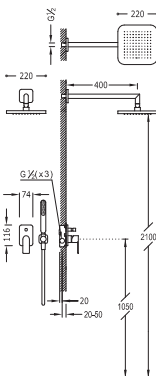

Kit de ducha monomando empotrado LOFT

- con cierre y regulación de caudal.
- Cuerpo empotrado incluido
- Rociador ducha INOX a pared 160x550 mm. (299.903.06).
- Soporte con toma pared (200.182.01).
- Ducha móvil anticalcárea (034.639.01).
- Flexo SATIN (91.34.609.15).

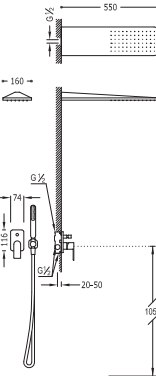

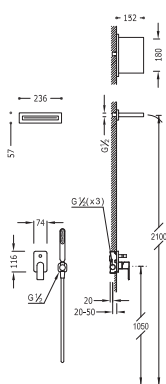

Kit de ducha monomando empotrado LOFT

- con cierre y regulación de caudal.
- Cuerpo empotrado incluido
- Ducha INOX con cascada 152x200 mm. (299.903.04).
- Soporte con toma pared (200.182.01).
- Ducha móvil anticalcárea (034.639.01).
- Flexo SATIN (91.34.609.15).

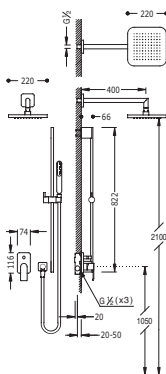

Kit de ducha monomando empotrado LOFT

- con cierre y regulación de caudal.
- Cuerpo empotrado incluido
- Ducha fija 220x220 mm. con rótula. (299.632.06).
- Codo toma pared (200.183.01).
- Barra deslizante long. 820 mm. (034.637.01).
- Ducha móvil anticalcárea (034.639.01).
- Flexo SATIN (91.34.609.15).

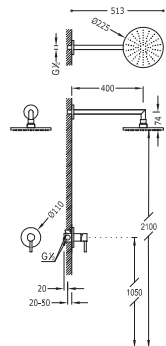

Kit de ducha monomando empotrado ALPLUS

- con cierre y regulación de caudal.
- Cuerpo empotrado incluido
- Ducha fija Ø 225 mm. con rótula. (299.632.01).





Kit de ducha monomando empotrado LEX

- con cierre y regulación de caudal.
- Cuerpo empotrado incluido
- Ducha fija Ø 250 mm. con rótula. (1.34.137.26).
- Soporte con toma pared (205.182.01).
- Ducha móvil masaje Ø 100 mm. (5 funciones) (1.34.748).
- Flexo SATIN (91.34.609.15).

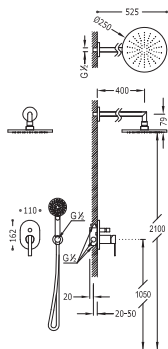

91.34.592
 Cr | 1.81.880.05



Kit de ducha monomando empotrado ALPLUS

- con cierre y regulación de caudal.
- Cuerpo empotrado incluido
- Ducha fija Ø 225 mm. con rótula. (299.632.01).
- Soporte con toma pared (205.182.01).
- Ducha móvil anticálcarea (299.631.03).
- Flexo SATIN (91.34.609.15).

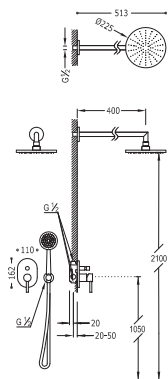

91.34.592
 Cr | 203.180.02



Kit de ducha monomando empotrado ALPLUS

- con cierre y regulación de caudal.
- Cuerpo empotrado incluido
- Ducha fija Ø 225 mm. con rótula. (299.632.01).
- Barra deslizante long. 550 mm. (1.34.618).
- Codo toma pared (205.183.01).
- Ducha móvil anticálcarea (299.631.03).
- Flexo SATIN (91.34.609.15).

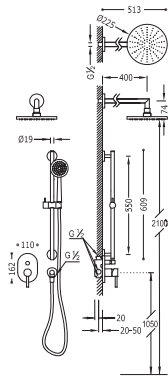

91.34.592
 Cr | 203.180.03



Kit de ducha monomando empotrado FLAT

- con cierre y regulación de caudal.
- Cuerpo empotrado incluido
- Soporte con toma pared (205.182.01).
- Ducha móvil anticalcárea (1.34.617).
- Flexo SATIN (g1.34.609.15).

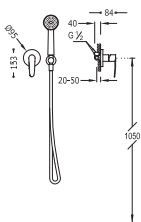

Kit de ducha monomando empotrado FLAT

- con cierre y regulación de caudal.
- Cuerpo empotrado incluido
- Ducha fija Ø 225 mm. con rótula. (299.632.01).
- Soporte con toma pared (205.182.01).
- Ducha móvil anticalcárea (1.34.617).
- Flexo SATIN (g1.34.609.15).

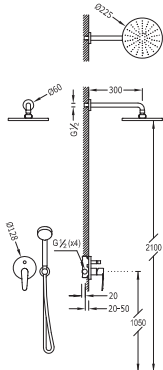

KIT DEPÓSITO PARA BAÑERAS DE REPISA

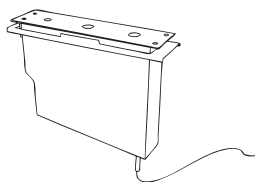
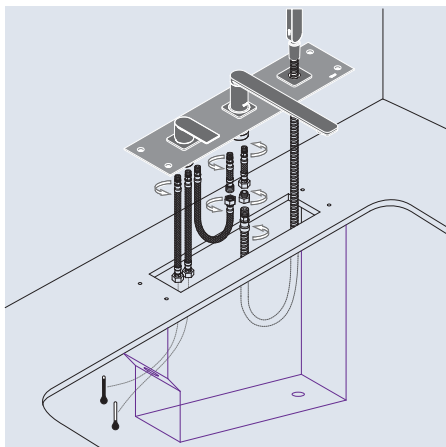

FACILITA LA INSTALACIÓN Y GARANTIZA LA ESTANQUEIDAD

El kit depósito permite el montaje superior del grifo de repisa, facilitando su instalación.

El sistema patentado de instalación no necesita registros.

El depósito es estanco y comunica con el desagüe de la bañera para expulsar los restos de agua que se puedan introducir.

Incluye una placa de latón cromada embellecedora para mejorar el acabado de la parte visible.



BAÑERAS DE REPISA

Ref.:

Monomando bañera de repisa CUADRO

- con ducha anticálcaea (006.639.01).
- Caudal: 3 bar - 13 l/m.
- Compatible con el kit depósito ref: 200.245.01.
- NOTA: ver longitud caño.

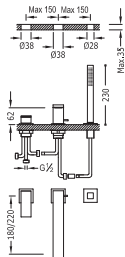

91.30.190 BIELABOR (180 mm.)
Cr | 006.161.06

91.30.190 BIELABOR (220 mm.)
Cr | 006.161.04

91.30.190 BIELABOR (180 mm.)
Cr | 006.161.05

91.30.190 BIELABOR (220 mm.)
Cr | 006.161.03



Monomando bañera de repisa CLASS

- con ducha anticálcaea (299.631.08).
- Caudal: 3 bar - 13 l/m.
- Compatible con el kit depósito ref: 200.245.01.
- NOTA: ver longitud caño.

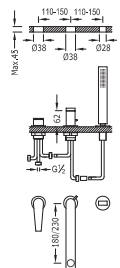

91.30.190 BIELABOR (180 mm.)
Cr | 205.161.03

91.30.190 BIELABOR (230 mm.)
Cr | 205.161.01



Monomando bañera de repisa LOFT

con ducha anticalcárea (034.639.01).
 · Caudal: 3 bar – 16 l/m.
 · Compatible con el kit depósito ref: 203.245.01.
 · NOTA: ver longitud caño.

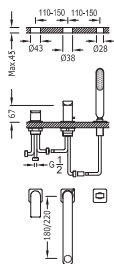

91.34.591 (180 mm)
 Cr 200.162.03

91.34.591 (220 mm)
 Cr 200.162.01

Monomando bañera de repisa MAX

con ducha anticalcárea (034.116.01).
 · Caudal: 3 bar – 16 l/m.
 · Compatible con el kit depósito ref: 203.245.01.
 · NOTA: ver longitud caño.

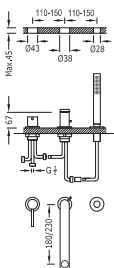

91.34.591 (180 mm)
 Cr 062.161.03

91.34.591 (230 mm)
 Cr 062.161.02



Monomando bañera de repisa LEX

Ducha móvil masaje Ø 100 mm. (5 funciones) (1.34.748).
 · Caudal: 3 bar – 16 l/m.
 · Compatible con el kit depósito ref: 203.245.01.
 · NOTA: ver longitud caño.

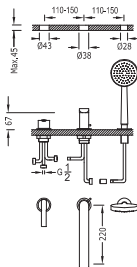

91.34.591 (180 mm)
 Cr 081.161.04

91.34.591 (220 mm)
 Cr 081.161.03

Monomando bañera de repisa LEX

Ducha móvil masaje Ø 100 mm. (5 funciones) (1.34.748).
 · Caudal: 3 bar – 16 l/m.
 · Compatible con el kit depósito ref: 1.89.245.

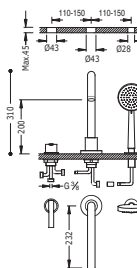

91.34.591 (180 mm)
 Cr 081.150.01

Batería bañera de repisa

Ducha móvil anticalcárea (034.116.01).
 - Caudal: 3 bar – 17 l/m.
 - Compatible con el kit depósito ref: 1.34.345.



Cr | 1.63.145



Monomando bañera de repisa ALPLUS

Ducha móvil anticalcárea (299.631.03).
 - Caudal: 3 bar – 16 l/m.
 - Compatible con el kit depósito ref: 203.245.01.
 - NOTA: ver longitud caño.

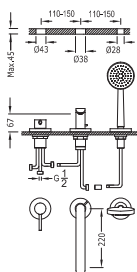

Cr | 203.161.02



Cr | 203.161.01

Monomando bañera de repisa CUADRO

con caño cascada y ducha móvil anticalcárea (006.639.01).
 - Caudal: 3 bar – 13 l/m.
 - Compatible con el kit depósito ref: 1.06.245.

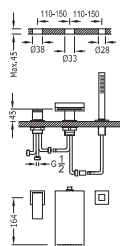

Cr | 1.07.161.02



Cr | 1.06.161.02



Monomando bañera de repisa MAX

con caño cascada y ducha móvil anticalcárea (034.116.01).
 - Caudal: 3 bar – 17 l/m.
 - Compatible con el kit depósito ref: 1.62.245.

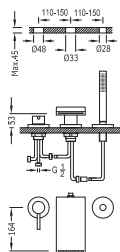

Cr | 061.161.01



Cr | 1.62.161



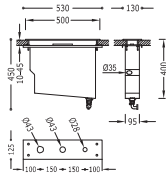

Kit depósito para bañeras de repisa

Fácil montaje superior. Sin registros (para ref.: 081.150.01).

Cr | 1.89.245 |

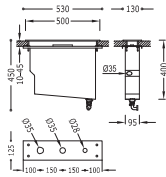

Kit depósito para bañeras de repisa

Fácil montaje superior. Sin registros (para ref.: 1.42.145.02).

Cr | 1.34.245 |

Válvula bañera con toma drenaje

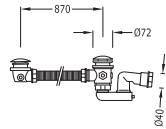

Cr | 1.34.445 |







TRES SELECTION

CUADRO-TRES

- 404 Lavabos
- 412 Bidé
- 413 Monomandos de superficie
- 414 Monomandos empotrados
- 416 Bañeras de repisa
- 417 Termostáticas de superficie
- 153 Accesorios

RECAMBIOS DE LOS ARTÍCULOS EN:
www.tresgriferia.com

LAVABOS

Ref:

Monomando lavabo

con caño cascada. *NOTA: La grifería con caño cascada se acompaña con 2 llaves de regulación con filtro (Ref: 91.34.525).

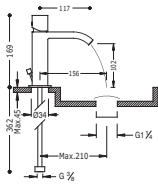

Cr 006.101.02
 299.190.01
 Cr 006.101.02.D
 299.190.01

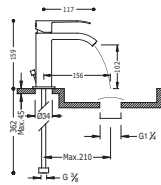

Cr 006.101.01
 299.190.01
 Cr 006.101.01.D
 299.190.01

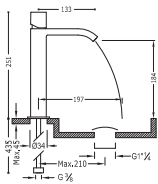

Ref:

Monomando lavabo

con caño cascada libre. * NOTA: La grifería con caño cascada se acompaña con 2 llaves de regulación con filtro (Ref: 91.34.525).

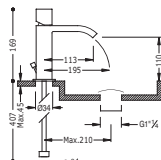

299.190.02		
Cr	006.110.02	
299.190.02		
Cr	006.110.02.D	

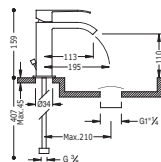

299.190.02		
Cr	006.110.01	
299.190.02		
Cr	006.110.01.D	

Monomando lavabo

con caño cascada. * NOTA: La grifería con caño cascada se acompaña con 2 llaves de regulación con filtro (Ref: 91.34.525).

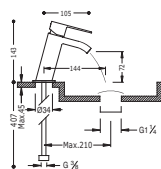

299.190.01		
Cr	006.201.01	

Monomando lavabo

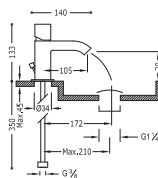

91.30.190
Cr | **1.07.103**

91.30.190
Cr | **1.07.103.DA**

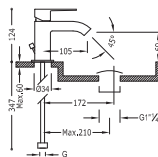

91.30.190
Cr | **1.06.103**

91.30.190
Cr | **1.06.103.DA**

Monomando lavabo
caño de 34x10 mm.

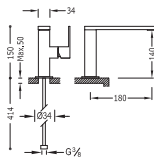

91.30.190
Cr | **1.06.205.01**

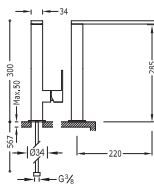

91.30.190
Cr | **006.485.01**

Ref:

Monomando lavabo
caño de 35x15 mm.

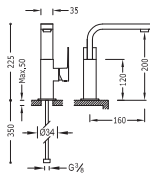

Cr | 1.06.603

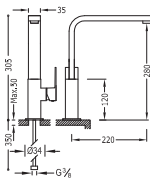

Cr | 1.06.604

Monomando lavabo
caño de 22x22 mm.

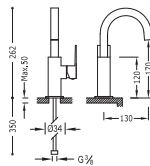

Cr | 1.06.605

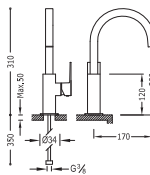

Cr | 1.06.606

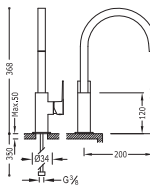

Cr | 1.06.607

Ref:

Bimando vertical
caño de 35x15 mm.

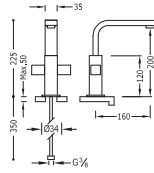

Cr | 1.08.604

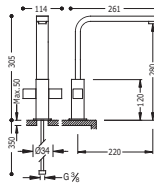

Cr | 1.08.496

Bimando vertical
caño de 22x22 mm.

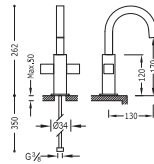

Cr | 1.08.605

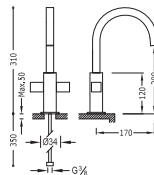

Cr | 1.08.606

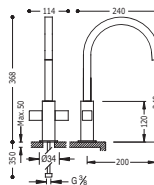

Cr | 1.08.497

Ref:

Monomando lavabo de repisa
De instalación libre. Caño de 22x22 mm.

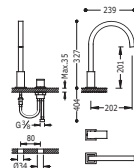

Cr **006.105.03**

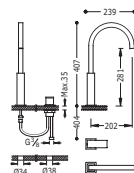

Cr **006.105.04**

Bimando de repisa
De instalación libre. Caño de 22x22 mm.

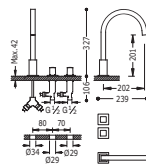

Cr **008.105.03**

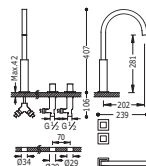

Cr **008.105.04**

Ref:

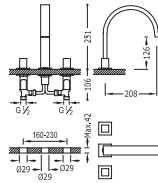

Bimando de repisa

De instalación libre. Caño 35x15 mm. con aireador rectangular oculto.



91.34.282

Cr | 008.105.01

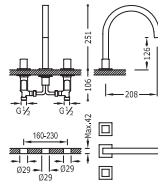

Bimando de repisa

De instalación libre. Caño de 22x22 mm.



91.34.282

Cr | 008.105.02

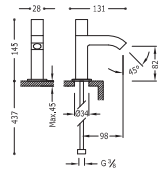

Grifo lavabo 1 agua o pmezclada



91.08.295.10

Cr | 1.07.503

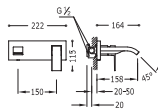

Monomando mural

con caño cascada. Cuerpo empotrado incluido e indivisible.



299.190.01

Cr | 006.260.01

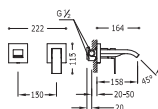

Monomando mural

con caño cascada. Cuerpo empotrado incluido e indivisible.



299.190.01

Cr | 006.260.10

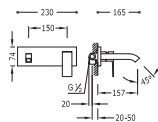

Monomando mural

con aireador. Cuerpo empotrado incluido e indivisible.



91.30.190

Cr | 1.06.200



Ref:

Monomando mural

con aireador. Cuerpo empotrado incluido e indivisible.

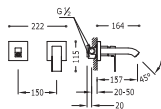

Cr **006.200.10**

Monomando mural

Cuerpo empotrado incluido e indivisible.

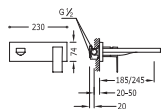

Cr **006.200.03** (185 mm.)



Cr **006.200.04** (245 mm.)

Monomando mural

Cuerpo empotrado incluido e indivisible.

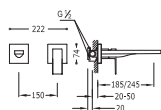

Cr **006.200.12** (185 mm.)



Cr **006.200.11** (245 mm.)

Bimando mural

con caño cascada. Cuerpo empotrado incluido e indivisible.

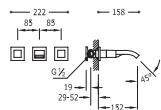

Cr **008.152.01**

Bimando mural

con aireador. Cuerpo empotrado incluido e indivisible.

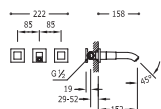

Cr **008.151.01**

Bimando mural

Cuerpo empotrado incluido e indivisible.

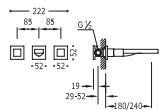

Cr **008.153.01** (180 mm.)



Cr **008.154.01** (240 mm.)

BIDÉ

Ref:

Monomando bidé

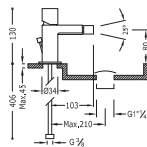

Cr 007.120.01



Cr 007.120.01.D

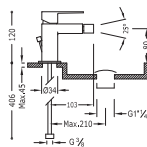

Cr 006.120.01



Cr 006.120.01.D

Monomando bidé

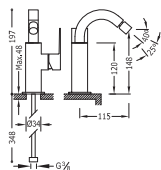

Cr 1.06.124

Bimando bidé

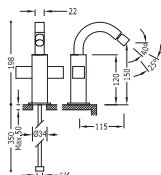

Cr 1.08.124

Monomando bidé con ducha

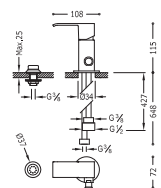

Cr 006.130.01

Ref:

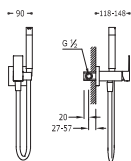

Monomando mezclador empotrar para bidé WC

Soporte derecha o izquierda, cambiabile. Ducha de latón con racor limitador 5 l/m. Antigoteo y flexo SATIN. * Opción para paredes de Pladur



Cr 006.123.01

Cr 006.123.02*



Accesorio porta toallas

180 mm. (para ref.: 006.123.01, 006.123.02). * NOTA: Soporte derecha o izquierda, cambiabile.

Cr 034.124.02

MONOMANDOS DE SUPERFICIE

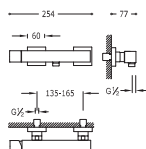

Monomando ducha

Ducha de mano anticalcárea (006.639.01) con soporte orientable y flexo SATIN (91.34.609.15).



Cr 1.07.167

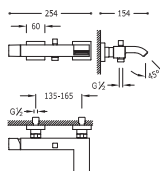

Monomando bañera-ducha

con cascada. Ducha de mano anticalcárea (006.639.01) con soporte orientable. Flexo SATIN (91.34.609).



Cr 1.07.170.02

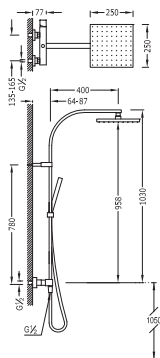

Conjunto ducha monomando anticalcárea

· Ducha fija 250x250 mm. con rótula. (1.34.138.26).
· Ducha móvil anticalcárea (006.639.01).
· Flexo SATIN (91.34.609.15).



Cr 007.191.01

MONOMANDOS EMPOTRADOS

Ref:

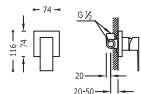

Monomando empotrar (1 vía)
cuerpo empotrado incluido

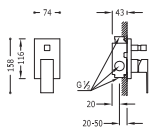

Monomando empotrar (2 vías)
cuerpo empotrado incluido



Alargadera para monomando empotrar ducha



Alargadera para monomando empotrar baño-ducha

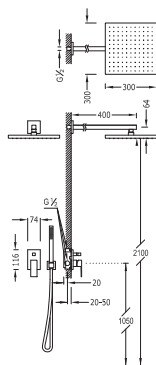

Kit de ducha monomando empotrado

- con cierre y regulación de caudal.
 - Cuerpo empotrado incluido
 - Ducha fija 300x300 mm. con rótula. Material Latón. (1.34.138.30).
 - Soporte con toma pared (006.182.01).
 - Ducha móvil anticálcarea (006.639.01).
 - Flexo SATIN (91.34.609.15).



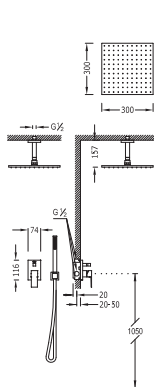

Kit de ducha monomando empotrado

- con cierre y regulación de caudal.
- Cuerpo empotrado incluido
- Ducha fija 300x300 mm. con rótula. Material Latón. (1.34.138.30).
- Soporte con toma pared (006.182.01).
- Ducha móvil anticalcárea (006.639.01).
- Flexo SATIN (91.34.609.15).



Cr 006.180.80

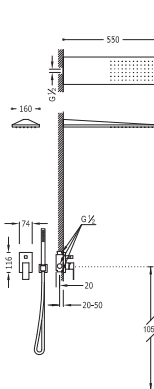

Kit de ducha monomando empotrado

- con cierre y regulación de caudal.
- Cuerpo empotrado incluido
- Rociador ducha INOX a pared 160x550 mm. (299.903.03).
- Soporte con toma pared (006.182.01).
- Ducha móvil anticalcárea (006.639.01).
- Flexo SATIN (91.34.609.15).



Cr 006.180.03

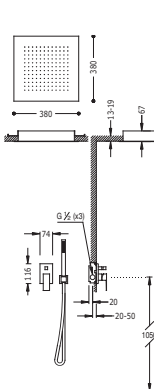

Kit de ducha monomando empotrado

- con cierre y regulación de caudal.
- Cuerpo empotrado incluido
- Rociador ducha INOX a techo 380x380 mm. (1.34.944).
- Soporte con toma pared (006.182.01).
- Ducha móvil anticalcárea (006.639.01).
- Flexo SATIN (91.34.609.15).



Cr 006.980.01

BAÑERAS DE REPISA

Ref:

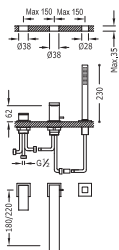

Monomando bañera de repisa
 con ducha anticálcea (006.639.01).
 - Caudal: 3 bar - 13 l/m.
 - Compatible con el kit depósito ref: 200.245.01.
 - NOTA: ver longitud caño.



Cr | 006.161.06



Cr | 006.161.04



Cr | 006.161.05



Cr | 006.161.03



Kit depósito para bañeras de repisa
 (para ref.: 006.161.06, 006.161.04, 006.161.05,
 006.161.03, 205.161.03, 205.161.01).

Cr | 200.245.01 | 400



Válvula bañera con toma drenaje

Cr | 1.34.445 | 400

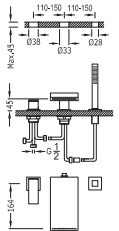

Monomando bañera de repisa
 con caño cascada y ducha móvil anticálcea (006.639.01).
 - Caudal: 3 bar - 13 l/m.
 - Compatible con el kit depósito ref: 1.06.245.



Cr | 1.07.161.02



Cr | 1.06.161.02



Kit depósito para bañeras de repisa
 (para ref.: 1.07.161.02, 1.06.161.02).

Cr | 1.06.245 | 400



Válvula bañera con toma drenaje

Cr | 1.34.445 | 400



TERMOSTÁTICAS DE SUPERFICIE

Ref:

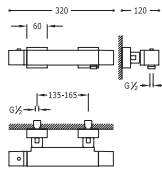

Ducha termostática

(Ducha de mano anticalcárea con soporte orientable y flexo SATIN (91.34.609.15)).



91.06.161.10
Cr | 1.07.164

91.06.161.10
Cr | 1.07.164.9

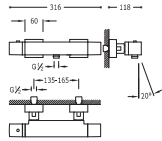

Bañera-ducha termostática

con cascada (Ducha de mano anticalcárea con soporte orientable y flexo SATIN (91.34.609)).



91.06.161.10
Cr | 1.07.174

91.06.161.10
Cr | 1.07.174.9

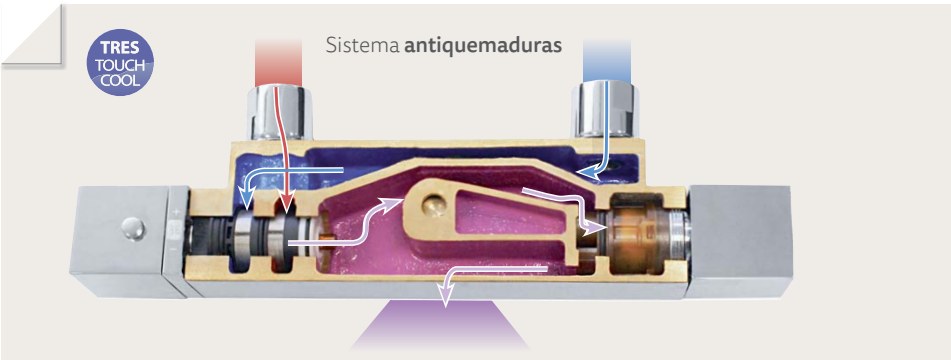

LLAVES DE PASO

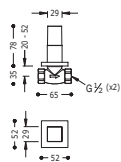

Llave de paso 1/2"

Cr | 007.155.01

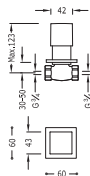

Llave de paso 3/4"

Cr | 1.07.511



TRES SELECTION

MAX-TRES

- 420 Lavabos
- 426 Bidé
- 427 Monomandos de superficie
- 429 Monomandos empotrados
- 431 Bañeras de repisa
- 432 Termostáticas de superficie
- 153 Accesorios

RECAMBIOS DE LOS ARTÍCULOS EN:
www.tresgriferia.com

LAVABOS

Ref:

Monomando lavabo

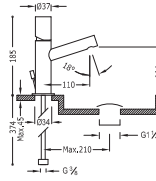

91.027.190.05

Cr **061.103.01**

91.027.190.05

Cr **061.103.01.D**

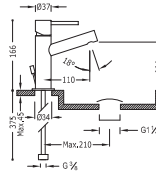

91.027.190.05

Cr **062.103.01**

91.027.190.05

Cr **062.103.01.D**

Monomando lavabo

con caño cascada libre. NOTA: La grifería con caño cascada se acompaña con 2 llaves de regulación con filtro (Ref. 91.34.525).

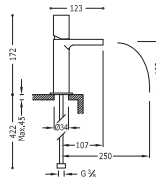

91.30.190

Cr **061.110.01**

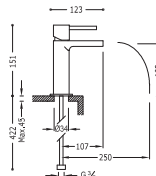

91.30.190

Cr **062.110.01**

Monomando lavabo
Caño largo

MEDIDAS ESPECIALES

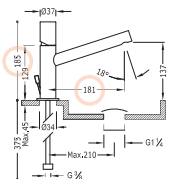

Cr 061.203.01

Cr 061.203.01.D

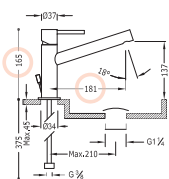

Cr 062.203.01

Cr 062.203.01.D

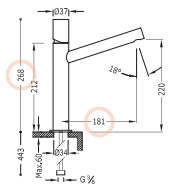

Cr 061.206.01

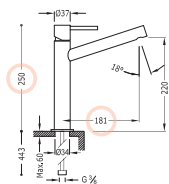

Cr 062.206.01

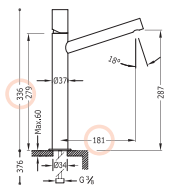

Cr 061.207.01

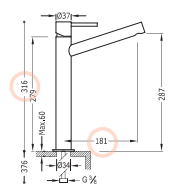

Cr 062.207.01

Monomando lavabo

NOTA: La grifería con caño cascada se acompaña con 2 llaves de regulación con filtro (Ref: 91.34.525).

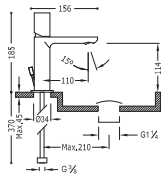

- 91.30.190 Cr **061.103.02**
- 91.30.190 Cr **061.103.02.D**
- 91.30.190 Cr **061.103.03**
- 91.30.190 Cr **061.103.03.D**

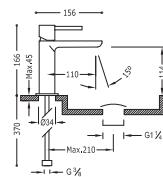

- 91.30.190 Cr **062.103.02**
- 91.30.190 Cr **062.103.02.D**
- 91.30.190 Cr **062.103.03**
- 91.30.190 Cr **062.103.03.D**

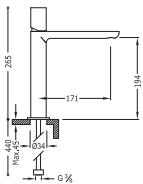

- 91.30.190 Cr **061.203.04**

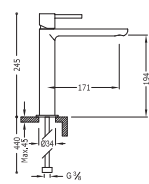

- 91.30.190 Cr **062.203.04**

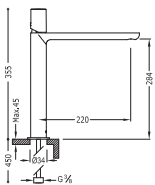

- 91.30.190 Cr **061.203.06**

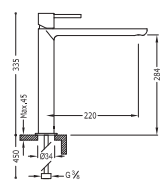

- 91.30.190 Cr **062.203.06**

Monomando lavabo
caño de 34x9 mm.

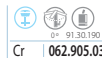
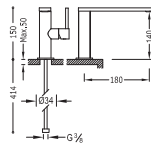

Cr | **062.905.03**

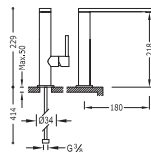

Cr | **062.905.02**

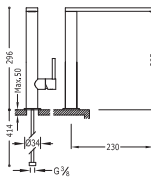

Cr | **062.905.01**

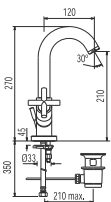

Bimando lavabo



Cr | **1.63.103**



Cr | **1.68.103**

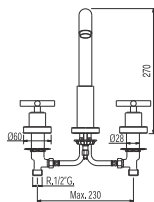

Bimando mural
De instalación libre.



Cr | **1.68.105**

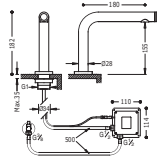

Lavabo electrónico 1 agua TOUCH-TRES
Sistema sensible al tacto. Sólo tocar (NO pulsar)



Cr | **061.447.01** |

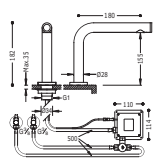

Lavabo electrónico mezclador TOUCH-TRES
Sistema sensible al tacto. Sólo tocar (NO pulsar). NOTA: Incluye un grifo mezclador dos aguas con tubos flexibles (ref. 1.92.507.30).



Cr | **061.448.01** |

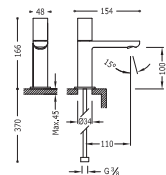

Grifo lavabo 1 agua o premezclada



Cr | **200.503.01** |

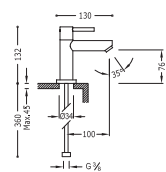

Grifo lavabo 1 agua o premezclada

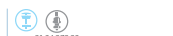

Cr | **1.62.503** |

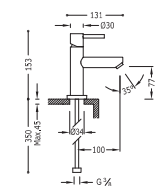

Monomando lavabo Ø 30 mm.



Cr | **1.62.150** |

Monomando mural

Cuerpo empotrado incluido e indivisible.

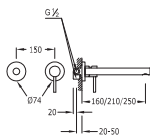

91.30.190 (160 mm.)

Cr | 062.200.70

91.30.190 (210 mm.)

Cr | 062.200.71

91.30.190 (250 mm.)

Cr | 062.200.03

Monomando mural

Cuerpo empotrado incluido e indivisible.

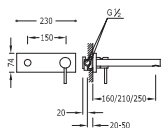

91.34.592 (160 mm.)

Cr | 062.200.01

91.34.592 (210 mm.)

Cr | 062.200.02

91.34.592 (250 mm.)

Cr | 1.62.200

Monomando mural

con caño cascada. Cuerpo empotrado incluido e indivisible.

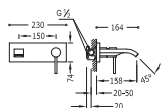

399.110.01

Cr | 062.260.10

Bimando mural

Cuerpo empotrado incluido e indivisible.

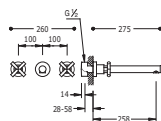

91.34.262 (160 mm.)

Cr | 1.63.152

91.34.262 (250 mm.)

Cr | 1.63.151

BIDÉ

Ref:

Monomando bidé

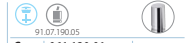
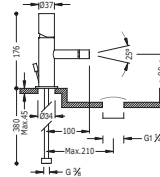

Cr 061.120.01



Cr 061.120.01.D

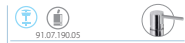
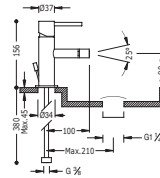

Cr 062.120.01



Cr 062.120.01.D

Monomando bidé

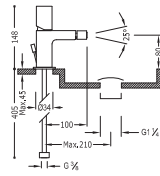

Cr 061.220.01



Cr 061.220.01.D

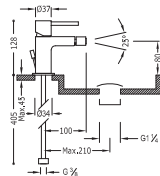

Cr 062.220.01



Cr 062.220.01.D

Bimando bidé

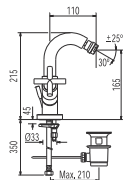

Cr 1.63.120



Cr 1.68.120

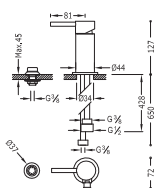

Monomando bidé con ducha



91.34.592

Cr 062.130.01

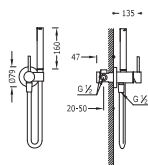

Monomando empotrar para bidé WC

Soporte derecha o izquierda, cambiable. Ducha de latón con racord limitador 5 l/m. Antigoteo y flexo SATIN. * Opción para paredes de Pladur



91.34.591

Cr 1.34.123

Cr 1.34.122*



Accesorio porta toallas

180 mm. (para ref.: 1.34.122, 1.34.123, 1.81.122, 1.81.123, 1.81.222, 1.81.223, 205.222.01, 205.223.01). NOTA: Soporte derecha o izquierda, cambiable.

Cr 034.124.01

MONOMANDOS DE SUPERFICIE

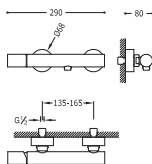

Monomando ducha

Ducha de mano anticalcárea (299.748.02) con soporte orientable y flexo SATIN (91.34.609.15).



91.30.190

Cr 061.167.01

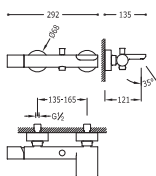

Monomando bañera-ducha

con cascada. Ducha de mano anticalcárea (299.748.02) con soporte orientable y flexo SATIN (91.34.609).



91.30.190

Cr 061.170.01

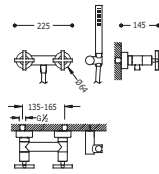

Grupo ducha

Ducha de mano anticálcarea (034.116.01) con soporte orientable y flexo SATIN (91.34.609.15).



Cr | 1.63.868

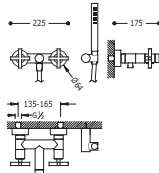

Grupo bañera

Ducha de mano anticálcarea (034.116.01) con soporte orientable y flexo SATIN (91.34.609).



Cr | 1.63.874

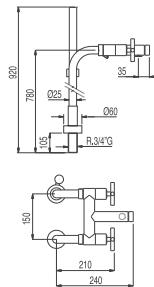

Grupo bañera con tomas a suelo

Ducha de mano anticálcarea (034.116.01) con soporte orientable y flexo SATIN (91.34.609).



Cr | 1.63.194

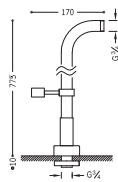

Tomas de agua a suelo de bañera

2 unidades con soporte ducha giratorio

Cr | 1.61.194

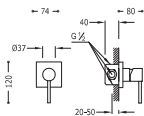

Monomando empotrar (1 vía)
cuerpo empotrado incluido



Cr | 062.177.02

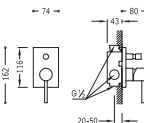

Monomando empotrar (2 vías)
cuerpo empotrado incluido



Cr | 062.180.02

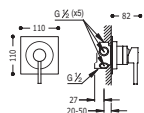

Distribuidor empotrado de 5 vías
con cierre y regulación de caudal (1 entrada y 5 salidas), Cuerpo empotrado incluido.



Cr | 1.34.550

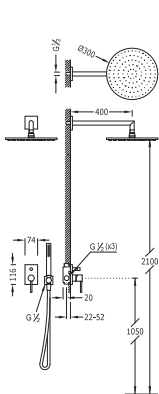

Kit de ducha monomando empotrado

- con cierre y regulación de caudal.
- Cuerpo empotrado incluido
- Ducha fija Ø 300 mm. con rótula. (1.34.137.30). Material Latón.
- Soporte con toma pared (061.182.01).
- Ducha móvil anticalcárea (034.116.01).
- Flexo SATIN (91.34.609.15).



Cr | 062.980.01

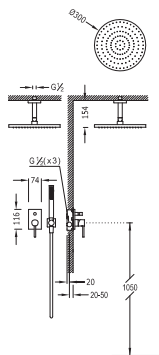

Kit de ducha monomando empotrado

con cierre y regulación de caudal.

- Cuerpo empotrado incluido
- Ducha fija Ø 300 mm. con rótula. (1.34.137.30). Material Latón.
- Soporte con toma pared (061.182.01).
- Ducha móvil anticalcárea (034.116.01).
- Flexo SATIN (91.34.609.15).



Cr 062.180.80

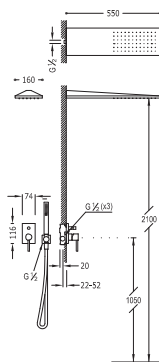

Kit de ducha monomando empotrado

con cierre y regulación de caudal.

- Cuerpo empotrado incluido
- Rociador ducha INOX a pared 160x550 mm. (299.903.03).
- Soporte con toma pared (061.182.01).
- Ducha móvil anticalcárea (034.116.01).
- Flexo SATIN (91.34.609.15).



Cr 062.516.01

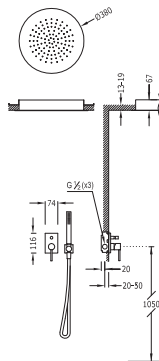

Kit de ducha monomando empotrado

con cierre y regulación de caudal.

- Cuerpo empotrado incluido
- Rociador ducha INOX a techo Ø 380 mm. (1.34.940).
- Soporte con toma pared (061.182.01).
- Ducha móvil anticalcárea (034.116.01).
- Flexo SATIN (91.34.609.15).



Cr 062.180.09

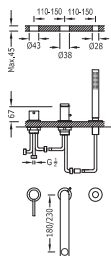

Monomando bañera de repisa
 con ducha anticalcárea (034.116.01).
 - Caudal: 3 bar - 16 l/m.
 - Compatible con el kit depósito ref: 203.245.01.
 - NOTA: ver longitud caño.

91.34.591 REJADERA (180 mm.)
 Cr | 062.161.03

91.34.591 REJADERA (230 mm.)
 Cr | 062.161.02



Kit depósito para bañeras de repisa
 (para ref.: 062.161.03, 062.161.02, 200.162.03, 200.162.01, 081.161.04, 081.161.03, 203.161.02, 203.161.01).

Cr | 203.245.01



Válvula bañera con toma drenaje

Cr | 1.34.445

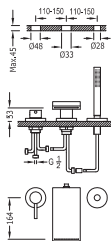

Monomando bañera de repisa
 con caño cascada y ducha móvil anticalcárea (034.116.01).
 - Caudal: 3 bar - 17 l/m.
 - Compatible con el kit depósito ref: 1.62.245.

91.34.288 REJADERA
 Cr | 061.161.01

91.34.288 REJADERA
 Cr | 1.62.161



Kit depósito para bañeras de repisa
 (para ref.: 061.161.01, 1.62.161, 261.150.01, 262.150.01).

Cr | 1.62.245



Válvula bañera con toma drenaje

Cr | 1.34.445



Batería bañera de repisa

Ducha móvil anticalcárea (034.116.01).

- Caudal: 3 bar - 17 l/m.

- Compatible con el kit depósito ref: 1.34.345.

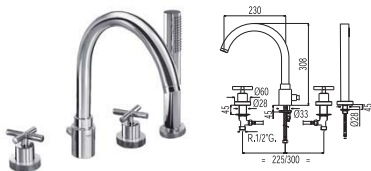

Cr | 1.63.145



Kit depósito para bañeras de repisa
(para ref.: 1.63.145, 1.32.145, 1.24.146).

Cr | 1.34.345

📦 400



Válvula bañera con toma drenaje

Cr | 1.34.445

📦 400

TERMOSTÁTICAS DE SUPERFICIE

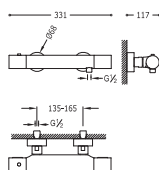

Ducha termostática

(Ducha de mano anticalcárea (299.748.02) con soporte orientable y flexo SATIN (91.34.609.15)).



299.195.03 Cr | 061.162.01



299.195.03 Cr | 061.162.09

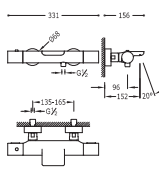

Bañera-ducha termostática

con cascada (Ducha de mano anticalcárea (299.748.02) con soporte orientable y flexo SATIN (91.34.609.15)).



299.195.03 Cr | 061.172.01



299.195.03 Cr | 061.172.09

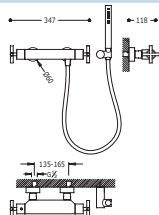

Ducha termostática

(Ducha de mano anticalcárea (034.116.01) con soporte orientable y flexo SATIN (91.34.609.15)).



299.163.01 Cr | 063.162.01



299.163.01 Cr | 063.162.09

Ref:

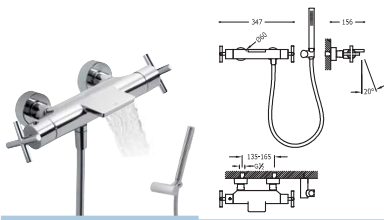

Bañera-ducha termostática

Con cascada (Ducha de mano anticalcárea (034.116.01) con soporte orientable y flexo SATIN (91.34.609)).



299.163.01
Cr 063.172.01



299.163.01
Cr 063.172.09

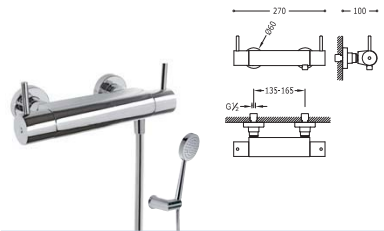

Ducha termostática

Ducha de mano anticalcárea (299.631.03) con soporte orientable y flexo SATIN (91.34.609.15). Indicado para personas con discapacidades físicas



299.195.09
Cr 090.264.01



299.195.09
Cr 090.964.01

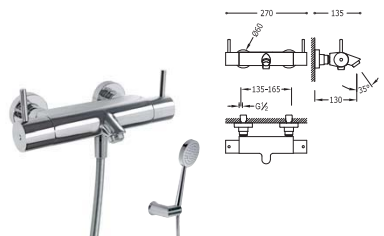

Bañera-ducha termostática

Ducha de mano anticalcárea (299.631.03) con soporte orientable y flexo SATIN (91.34.609). Indicado para personas con discapacidades físicas



299.195.09
Cr 090.274.01



299.195.09
Cr 090.974.01

LLAVES DE PASO

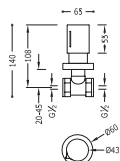

Llave de paso 1/2"

Cr 061.155.01

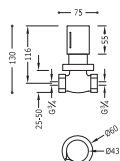

Llave de paso 3/4"

Cr 061.511.01



TRES SELECTION

LOFT-TRES

- 436 Lavabos
- 439 Bidé
- 440 Monomandos de superficie
- 440 Monomandos empotrados
- 442 Bañeras de repisa
- 442 Termostáticas de superficie
- 153 Accesorios

RECAMBIOS DE LOS ARTÍCULOS EN:
www.tresgriferia.com

LAVABOS

Ref:

Monomando lavabo

con caño cascada. * NOTA: La grifería con caño cascada se acompaña con 2 llaves de regulación con filtro (Ref: 91.34.525).

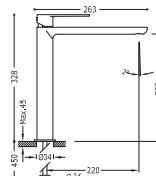
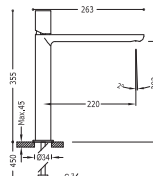
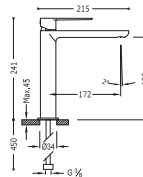
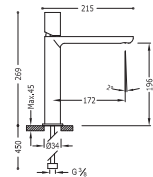
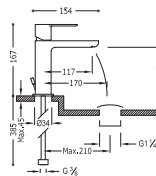
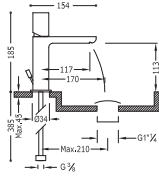

Monomando lavabo

con caño cascada libre. NOTA: La grifería con caño cascada se acompaña con 2 llaves de regulación con filtro (Ref: 91.34.525).

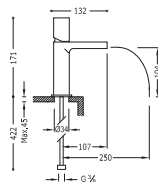

Cr 91.30.190 200.110.02

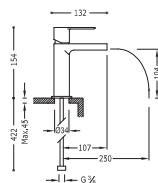

Cr 91.30.190 200.110.01

Monomando lavabo

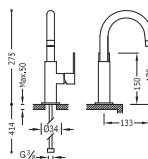

Cr 91.30.190 200.205.04

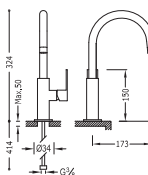

Cr 91.30.190 200.205.05

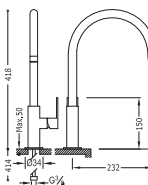

Cr 91.30.190 200.205.06



Ref:

Monomando lavabo
caño de 35x15 mm.

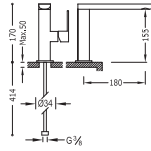

91.30.190
360° 91.30.190
Cr | **200.205.01**

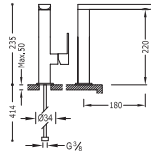

91.30.190
360° 91.30.190
Cr | **200.205.02**

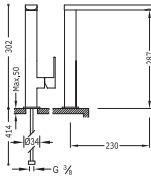

91.30.190
360° 91.30.190
Cr | **200.205.03**



Grifo lavabo 1 agua o premezclada

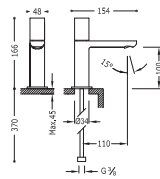

91.34.202
Cr | **200.503.01**

Monomando mural

Cuerpo empotrado incluido e indivisible.

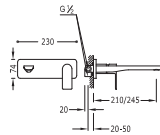

91.30.190 (210 mm.)
Cr | **200.200.03**

91.30.190 (245 mm.)
Cr | **200.200.02**

Monomando mural

con caño cascada. Cuerpo empotrado incluido e indivisible.

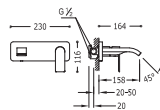

299.190.01
Cr | **200.260.10**

BIDÉ

Ref:

Monomando bidé

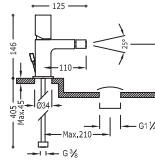

91.30.190			
Cr	200.120.02		
91.30.190			
Cr	200.120.02.D		

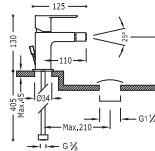

91.30.190			
Cr	200.120.01		
91.30.190			
Cr	200.120.01.D		

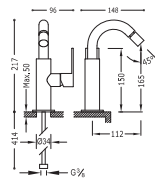

Monomando bidé

91.30.190			
Cr	200.224.01		
91.30.190			
Cr	200.224.01		

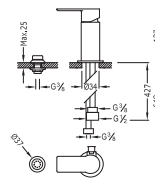

Monomando bidé con duchita

91.34.592			
Cr	200.130.01		

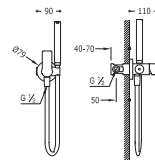

Monomando mezclador empotrar para bidé WC

Soporte derecha o izquierda, cambiabile. Duchá de latón con racor limitador 5 l/m. Antigoteo y flexo SATIN. * Opción para paredes de Pladur

91.34.591			
Cr	205.223.01		
Cr	205.222.01*		



Accesorio porta toallas

180 mm. (para ref.: 1.34.122, 1.34.123, 1.81.122, 1.81.123, 1.81.222, 1.81.223, 205.222.01, 205.223.01). NOTA: Soporte derecha o izquierda, cambiabile.

Cr	034.124.01		
----	------------	--	--

MONOMANDOS DE SUPERFICIE

Ref:

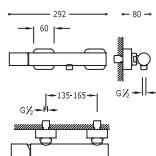

Monomando ducha

Ducha de mano anticalcárea (034.639.01) con soporte orientable y flexo SATIN (91.34.609.15).



91.30.190
Cr 200.167.01

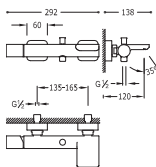

Monomando bañera-ducha

con cascada. Ducha de mano anticalcárea (034.639.01) con soporte orientable y flexo SATIN (91.34.609).



91.30.190
Cr 200.170.01

MONOMANDOS EMPOTRADOS

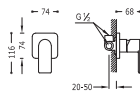

Monomando empotrar (1 vía)

cuerpo empotrado incluido



91.30.190
Cr 200.177.01

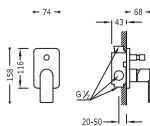

Monomando empotrar (2 vías)

cuerpo empotrado incluido



91.30.190
Cr 200.180.01



Alargadera para monomando empotrar baño-ducha



91.07.190.05
Cr 200.180.10

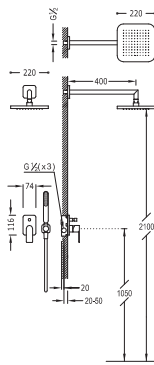

Kit de ducha monomando empotrado

- con cierre y regulación de caudal.
- Cuerpo empotrado incluido
- Ducha fija 220x220 mm. con rótula. (299.632.06).
- Soporte con toma pared (200.182.01).
- Ducha móvil anticalcárea (034.639.01).
- Flexo SATIN (91.34.609.15).

91.30.190 BELPARRA
Cr 200.180.02

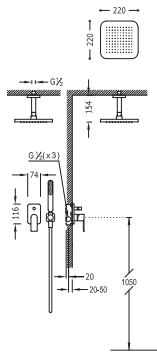

Kit de ducha monomando empotrado

- con cierre y regulación de caudal.
- Cuerpo empotrado incluido
- Ducha fija 220x220 mm. con rótula. (299.632.06).
- Soporte con toma pared (200.182.01).
- Ducha móvil anticalcárea (034.639.01).
- Flexo SATIN (91.34.609.15).

91.30.190 BELPARRA
Cr 200.180.80

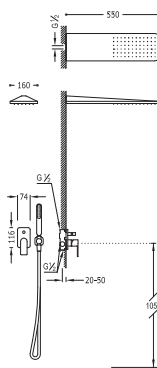

Kit de ducha monomando empotrado

- con cierre y regulación de caudal.
- Cuerpo empotrado incluido
- Rociador ducha INOX a pared 160x550 mm. (299.903.06).
- Soporte con toma pared (200.182.01).
- Ducha móvil anticalcárea (034.639.01).
- Flexo SATIN (91.34.609.15).



91.30.190 BELPARRA
Cr 200.180.05

BAÑERAS DE REPISA

Ref:

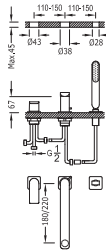

Monomando bañera de repisa

con ducha anticálcarea (034.639.01).

Caudal: 3 bar - 16 l/m.

Compatible con el kit depósito ref: 203.245.01.

NOTA: ver longitud caño.

91.34.591 (180 mm)

Cr | 200.162.03

91.34.591 (220 mm)

Cr | 200.162.01



Kit depósito para bañeras de repisa

(para ref.: 052.161.03, 052.161.02, 200.162.03, 200.162.01, 081.161.04, 081.161.03, 203.161.02, 203.161.01).

Cr | 203.245.01

📦 400



Válvula bañera con toma drenaje

Cr | 1.34.445

📦 400

TERMOSTÁTICAS DE SUPERFICIE

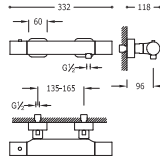

Ducha termostática

(Ducha de mano anticálcarea (034.639.01) con soporte orientable y flexo SATIN (91.34.609.15)).

209.195.03

Cr | 200.164.01

209.195.03

Cr | 200.164.09

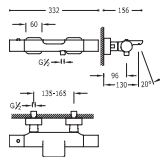

Bañera-ducha termostática

con cascada (Ducha de mano anticálcarea (034.639.01) con soporte orientable y flexo SATIN (91.34.609)).

209.195.03

Cr | 200.174.01

209.195.03

Cr | 200.174.09

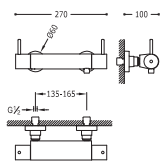

Ducha térmica

Ducha de mano anticalcárea (299.631.03) con soporte orientable y flexo SATIN (91.34.609.15). Indicado para personas con discapacidades físicas



299.195.09			
Cr	090.264.01		
299.195.09			
Cr	090.964.01		

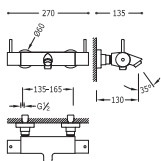

Bañera-ducha térmica

Ducha de mano anticalcárea (299.631.03) con soporte orientable y flexo SATIN (91.34.609). Indicado para personas con discapacidades físicas



299.195.09			
Cr	090.274.01		
299.195.09			
Cr	090.974.01		

LLAVES DE PASO

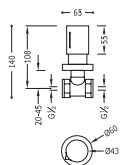

Llave de paso 1/2"

Cr 061.155.01

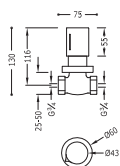

Llave de paso 3/4"

Cr 061.511.01



TRES SELECTION

CLASS-TRES



- 446 Lavabos
- 447 Bidé
- 447 Monomandos de superficie
- 447 Monomandos empotrados
- 449 Termostáticas de superficie
- 153 Accesorios

RECAMBIOS DE LOS ARTÍCULOS EN:
www.tresgriferia.com

LAVABOS

Ref:

Monomando lavabo

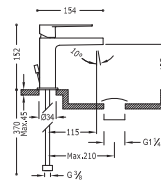

Cr | 205.103.01

Cr | 205.103.01.D

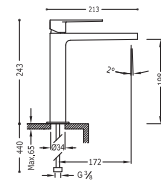

Cr | 205.103.03

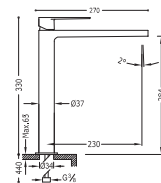

Cr | 205.103.05

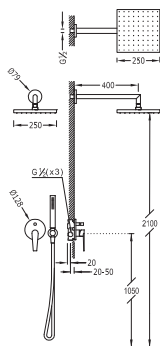

Kit de ducha monomando empotrado

con cierre y regulación de caudal.

- Cuerpo empotrado incluido
- Ducha fija 250x250 mm. con rótula. (1.34.138.26).
- Soporte con toma pared (205.182.01).
- Ducha móvil anticalcárea (299.631.08).
- Flexo SATIN (91.34.609.15).



Cr | 205.180.02

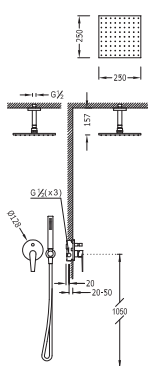

Kit de ducha monomando empotrado

con cierre y regulación de caudal.

- Cuerpo empotrado incluido
- Ducha fija 250x250 mm. con rótula. (1.34.138.26).
- Soporte con toma pared (205.182.01).
- Ducha móvil anticalcárea (299.631.08).
- Flexo SATIN (91.34.609.15).



Cr | 205.180.80

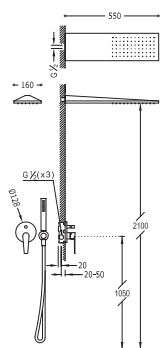

Kit de ducha monomando empotrado

con cierre y regulación de caudal.

- Cuerpo empotrado incluido
- Rociador ducha INOX a pared 160x550 mm. (299.903.03).
- Soporte con toma pared (205.182.01).
- Ducha móvil anticalcárea (299.631.08).
- Flexo SATIN (91.34.609.15).



Cr | 205.180.03

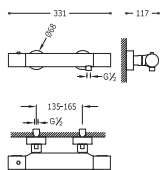

Ducha termostática

(Ducha de mano anticalcárea (299.631.08) con soporte orientable y flexo SATIN (91.34.609.15)).



299.195.03	RECALDA	
Cr	061.162.01	

299.195.03	RECALDA	
Cr	205.164.01.9	

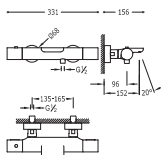

Bañera-ducha termostática

con cascada (Ducha de mano anticalcárea (299.631.08) con soporte orientable y flexo SATIN (91.34.609)).



299.195.03	RECALDA	
Cr	061.172.01	

299.195.03	RECALDA	
Cr	205.174.01.9	





TRES SELECTION

LEX-TRES

- 
- 
- 452 Lavabos
 - 455 Bidé
 - 457 Monomandos de superficie
 - 459 Monomandos empotrados
 - 460 Bañeras de repisa
 - 461 Termostáticas de superficie
 - 463 Termostáticas empotradas
 - 153 Accesorios

RECAMBIOS DE LOS ARTÍCULOS EN:
www.tresgriferia.com

LAVABOS

Ref:

Monomando lavabo

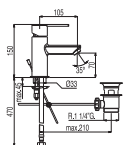

Cr | 1.81.103



Cr | 1.86.103

Monomando lavabo

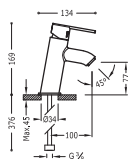

Cr | 1.81.903



Cr | 1.86.903

Ref:

Monomando lavabo
con alargadera

MEDIDAS ESPECIALES

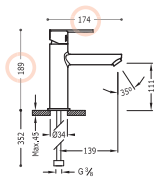

Cr 1.81.203



Cr 1.86.203

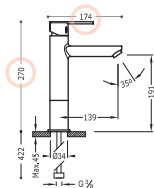

Cr 1.81.217



Cr 1.86.217

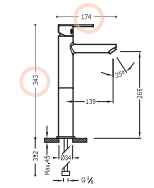

Cr 1.81.207



Cr 1.86.207



Monomando lavabo

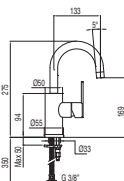

300° 91.34.592
 Cr | 1.81.703 |

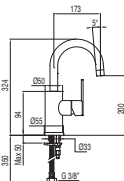

300° 91.34.592
 Cr | 1.81.403 |

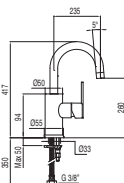

300° 91.34.592
 Cr | 1.81.303 |



Grifo lavabo 1 agua o premezclada

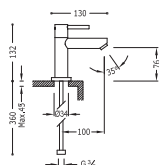

91.34.272.30
 Cr | 1.62.503 |

Monomando lavabo Ø 30 mm.

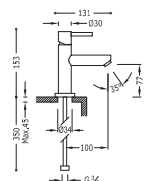

91.62.190
 Cr | 1.62.603 |

Ref:

Monomando mural

Cuerpo empotrado incluido e indivisible.

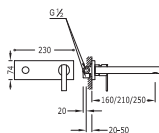

Cr 081.200.01 (160 mm.)



Cr 081.200.21 (210 mm.)



Cr 1.81.200 (250 mm.)

Monomando mural

con caño cascada. Cuerpo empotrado incluido e indivisible.

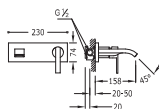

Cr 081.260.10

BIDÉ

Monomando bidé

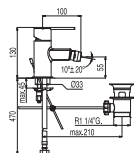

Cr 1.81.120



Cr 1.86.120

Monomando bidé

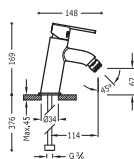

Cr 1.81.920



Cr 1.86.920

Monomando bidé

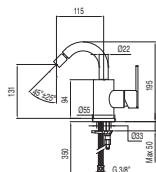

Cr 1.81.224



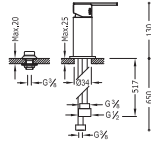

Monomando bidé con duchita



91.34.592
Cr | 081.130.01

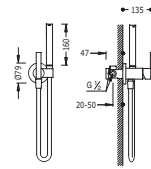

Monomando mezclador empotrar para bidé WC

Soporte derecha o izquierda, cambiabile. Ducha de latón con racor limitador 5 l/m. Antigoteo y flexo SATIN. * Opción para paredes de Pladur



91.34.591
Cr | 1.81.223
Cr | 1.81.222*

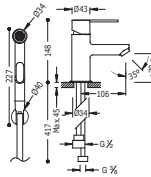

Monomando lavabo para WC

Duchita con cierre y flexo SATIN



91.34.592.10
Cr | 1.81.113



Accesorio porta toallas

180 mm. (para ref.: 1.34.122, 1.34.123, 1.81.122, 1.81.123, 1.81.222, 1.81.223, 205.222.01, 205.223.01). NOTA: Soporte derecha o izquierda, cambiabile.

Cr | 034.124.01

Monomando ducha

Ducha de mano masaje Ø 100 mm. (5 funciones) (1.34.748) con soporte orientable. Flexo SATIN (91.34.609.15).

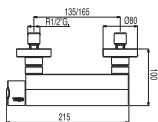

Cr | 1.81.468

Monomando bañera- ducha

Ducha de mano masaje Ø 100 mm. (5 funciones) (1.34.748) con soporte orientable. Flexo SATIN (91.34.609.15).

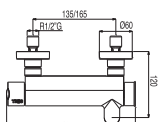

Cr | 1.81.474

Conjunto ducha anticálrea

· Ducha fija Ø 200 mm. con rótula. (299.632.12).
 · Ducha anticálrea Ø 80 mm. (1.34.617).
 · Flexo doble engatillado (91.34.828).

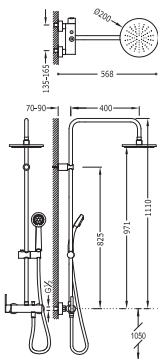

Cr | 081.192

Conjunto ducha anticálrea

· Ducha fija Ø 225 mm. con rótula. (299.632.01).
 · Ducha móvil masaje Ø 100 mm. (5 funciones) (1.34.748).
 · Flexo SATIN (91.34.609.15).

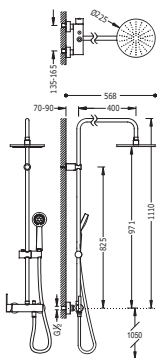

Cr | 1.81.191

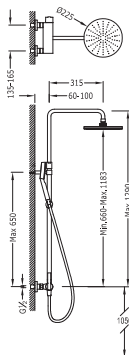

Conjunto ducha anticalcárea

- Ducha fija Ø 225 mm. con rótula. (299.632.01).
- Ducha móvil masaje Ø 100 mm. (5 funciones) (1.34.748).
- Flexo SATIN (91.34.609.15).
- Barra telescópica.



Cr 081.197.02

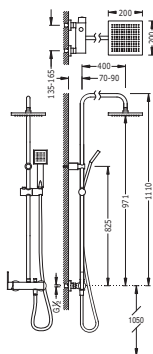

Conjunto ducha anticalcárea

- Ducha fija 200x200 mm. con rótula. (299.632.11).
- Ducha móvil anticalcárea (1.34.612).
- Flexo SATIN (91.34.609.15).



Cr 081.193.01

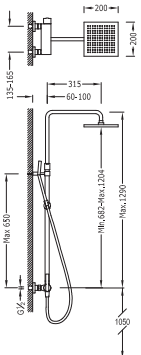

Conjunto ducha anticalcárea

- Ducha fija 200x200 mm. con rótula. (299.632.11).
- Ducha móvil anticalcárea (1.34.612).
- Flexo SATIN (91.34.609.15).
- Barra telescópica.



Cr 081.197.02

Monomando empotrar (1 vía)
cuerpo empotrado incluido



91.34.592
Cr | 1.81.177.05

Monomando empotrar (2 vías)
cuerpo empotrado incluido



91.34.592
Cr | 1.81.180.05

Kit de ducha empotrado

- con cierre y regulación de caudal.
- Cuerpo empotrado incluido
- Ducha fija Ø 250 mm. con rótula. (1.34.137.26).
- Soporte con toma pared (205.182.01).
- Ducha móvil masaje Ø 100 mm. (5 funciones) (1.34.748).
- Flexo SATIN (91.34.609.15).

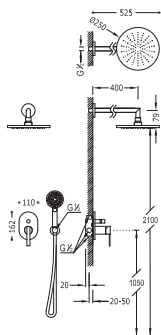

91.34.592
Cr | 1.81.880.05

BAÑERAS DE REPISA

Ref:

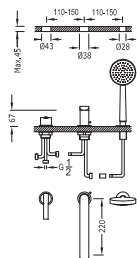

Monomando bañera de repisa

Ducha móvil masajé Ø 100 mm. (5 funciones) (1:34.748).
 Caudal: 3 bar - 16 l/m.
 Compatible con el kit depósito ref: 203.245.01.
 NOTA: ver longitud caño.

91.34.591 DRENAJE (180 mm.)
 Cr 081.161.04

91.34.591 DRENAJE (220 mm.)
 Cr 081.161.03



Kit depósito para bañeras de repisa

(para ref.: 062.161.03, 062.161.02, 200.162.03, 200.162.01, 081.161.04, 081.161.03, 203.161.02, 203.161.01).

Cr 203.245.01

400



Válvula bañera con toma drenaje

Cr 1.34.445

400

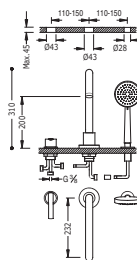

Monomando bañera de repisa

Ducha móvil masajé Ø 100 mm. (5 funciones) (1:34.748).
 Caudal: 3 bar - 14 l/m.
 Compatible con el kit depósito ref: 1.89.245.

91.34.591 DRENAJE
 Cr 081.150.01



Kit depósito para bañeras de repisa

(para ref.: 081.150.01).

Cr 1.89.245

400



Válvula bañera con toma drenaje

Cr 1.34.445

400

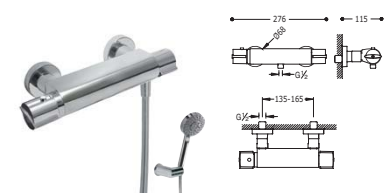

Ducha termostática

(Ducha de mano masaje Ø 100 mm. (5 funciones) (1.34.748) con soporte orientable. Flexo SATIN (91.34.609.15)).

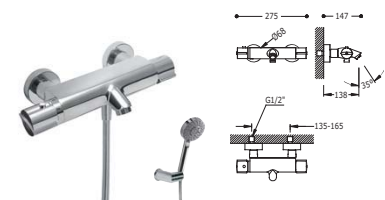

Bañera-ducha termostática

(Ducha de mano masaje Ø 100 mm. (5 funciones) (1.34.748) con soporte orientable. Flexo SATIN (91.34.609)).

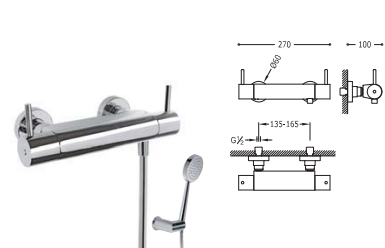

Ducha termostática

Ducha de mano anticalcárea (299.631.03) con soporte orientable y flexo SATIN (91.34.609.15). Indicado para personas con discapacidades físicas

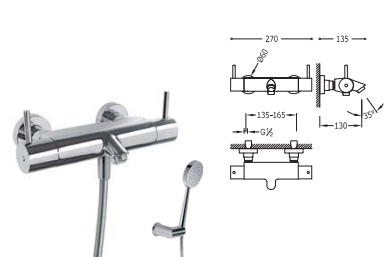

Bañera-ducha termostática

Ducha de mano anticalcárea (299.631.03) con soporte orientable y flexo SATIN (91.34.609). Indicado para personas con discapacidades físicas



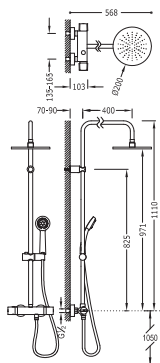

Conjunto ducha termostática

- Ducha fija Ø 200 mm. con rótula. (299.632.12).
- Ducha anticálcarea Ø 80 mm. (1.34.617).
- Flexo doble engatillado (91.34.828).
- Inversor integrado en el regulador de caudal.



299.195.03

Cr | 1.81.386

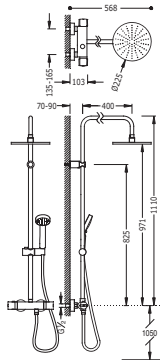

Conjunto ducha termostática

- Ducha fija Ø 225 mm. con rótula. (299.632.01).
- Ducha móvil masaje Ø 100 mm. (5 funciones) (1.34.748).
- Flexo SATIN (91.34.609.15).
- Inversor integrado en el regulador de caudal.



91.81.161.10

Cr | 1.81.385

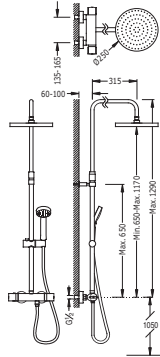

Conjunto ducha termostática

- Ducha fija Ø 250 mm. con rótula. (1.34.137.26).
- Ducha móvil masaje Ø 100 mm. (5 funciones) (1.34.748).
- Flexo SATIN (91.34.609.15).
- Barra telescópica.
- Inversor integrado en el regulador de caudal.



91.81.161.10

Cr | 1.90.214

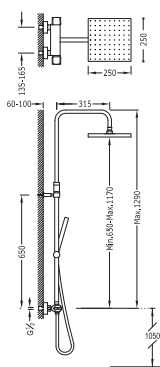

Conjunto ducha termostática

- Ducha fija 250x250 mm. con rótula. (1.34.138.26).
- Ducha móvil anticalcárea (006.639.01).
- Flexo SATIN (91.34.609.15).
- Barra telescópica.
- Inversor integrado en el regulador de caudal.



TERMOSTÁTICAS EMPOTRADAS

N

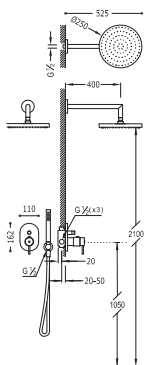

Kit de ducha termostático empotrado

- con cierre y regulación de caudal (2 vías).
- Cuerpo empotrado incluido
- Ducha fija Ø 250 mm. con rótula. Material Latón (1.34.137.26).
- Soporte con toma pared (205.182.01).
- Ducha móvil anticalcárea (034.116.01).
- Flexo SATIN (91.34.609.15).

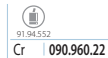



TRES SELECTION

ALPLUS

- 466 Lavabos
- 469 Bidé
- 471 Monomandos de superficie
- 472 Monomandos empotrados
- 473 Bañeras de repisa
- 473 Termostáticas de superficie
- 475 Termostáticas empotradas
- 153 Accesorios

RECAMBIOS DE LOS ARTÍCULOS EN:
www.tresgriferia.com

LAVABOS

Ref:

Monomando lavabo

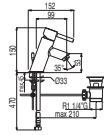

91.34.592 HB
Cr | 203.103.01

91.34.592 HB
Cr | 203.103.01.D

Monomando lavabo

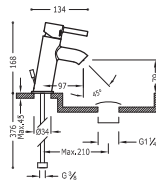

91.34.592 HB
Cr | 203.903.01

91.34.592 HB
Cr | 203.903.01.D

Monomando lavabo

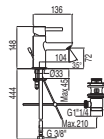

91.34.592 HB
Cr | 203.103.03

91.34.592 HB
Cr | 203.103.03.D



Monomando lavabo
con alargadera

MEDIDAS ESPECIALES

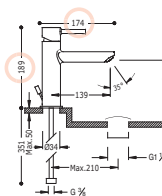

91.34.992
Cr | 203.203.01



91.34.992
Cr | 203.203.01.D

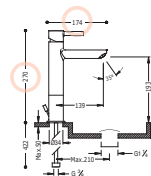

91.34.992
Cr | 203.217.01



91.34.992
Cr | 203.217.01.D

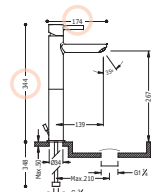

91.34.992
Cr | 203.207.01



91.34.992
Cr | 203.207.01.D

Monomando lavabo

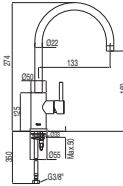

300° 91.34.592
 Cr | 203.703.01 |

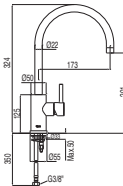

300° 91.34.592
 Cr | 203.403.01 |

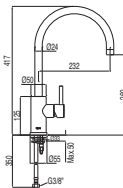

300° 91.34.592
 Cr | 203.303.01 |

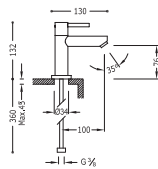

Grifo lavabo 1 agua o premezclada

91.34.272.20
 Cr | 1.62.503 |

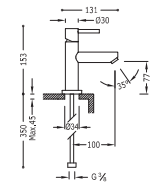

Monomando lavabo Ø 30 mm.

91.62.190
 Cr | 1.62.603 |

Ref:

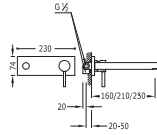

Monomando mural
Cuerpo empotrado incluido e indivisible.

91.34.592 (160 mm.)
Cr | **203.210.01**

91.34.592 (210 mm.)
Cr | **203.200.02**

91.34.592 (250 mm.)
Cr | **203.200.01**

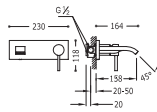

Monomando mural
con caño cascada. Cuerpo empotrado incluido e indivisible.

91.34.592.10
Cr | **203.260.10**

BIDÉ

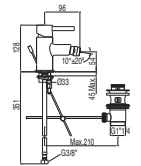

Monomando bidé

91.34.592 LA
Cr | **203.120.03**

91.34.592 LA
Cr | **203.120.03.D**

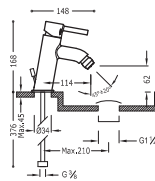

Monomando bidé

91.34.592
Cr | **203.920.01**

91.34.592
Cr | **203.920.01.D**

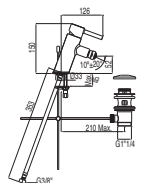

Monomando bidé

91.34.592 IB
Cr | **203.120.01**

91.34.592 IB
Cr | **203.120.01.D**

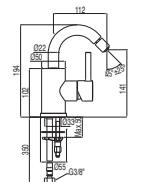

Monomando bidé

91.34.592
Cr | **203.224.01**



Ref: |

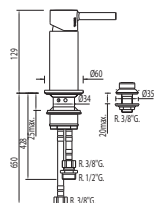

Monomando bidé con duchita



91.34.592

Cr | 203.130.01 |

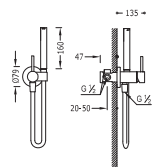

Monomando mezclador empotrar para bidé WC

Soporte derecha o izquierda, cambiabile. Duchita de latón con racor limitador 5 l/m. Antigoteo y flexo SATIN. * Opción para paredes de Pladur



91.34.591

Cr | 1.34.123 |

Cr | 1.34.122* |



Accesorio porta toallas

180 mm. (para ref.: 1.34.122, 1.34.123, 1.81.122, 1.81.123, 1.81.222, 1.81.223, 205.222.01, 205.223.01). NOTA: Soporte derecha o izquierda, cambiabile.

Cr | 034.124.01 |

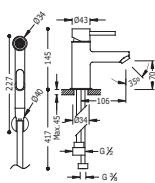

Monomando lavabo para bidé WC

Duchita con cierre y flexo SATIN



91.34.592.10

Cr | 1.62.113 |

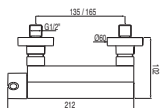

Monomando ducha

Ducha de mano anticalcárea (299.631.03) con soporte orientable y flexo SATIN (91.34.609.15).



Cr | 203.167.01

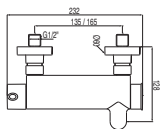

Monomando bañera-ducha

Ducha de mano anticalcárea (299.631.03) con soporte orientable y flexo SATIN (91.34.609).



Cr | 203.170.01

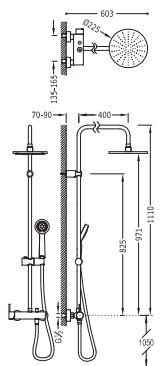

Conjunto ducha anticalcárea

- Ducha fija Ø 225 mm. con rótula. (299.632.01).
- Ducha móvil anticalcárea (299.631.03).
- Flexo SATIN (91.34.609.15).



Cr | 203.191.01

BAÑERAS DE REPISA

Ref:

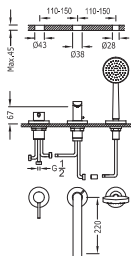

Monomando bañera de repisa

Ducha móvil anticalcárea (299.631.03).
 - Caudal: 3 bar - 16 l/m.
 - Compatible con el kit depósito ref: 203.245.01.
 - NOTA: ver longitud caño.

91.34.591 (180 mm.)
 Cr | 203.161.02

91.34.591 (220 mm.)
 Cr | 203.161.01



Kit depósito para bañeras de repisa
 (para ref.: 062.161.03, 062.161.02, 200.162.03,
 200.162.01, 081.161.04, 081.161.03, 203.161.02,
 203.161.01).

Cr | 203.245.01

400



Válvula bañera con toma drenaje

Cr | 1.34.445

400

TERMOSTÁTICAS DE SUPERFICIE

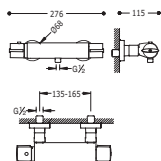

Ducha termostática

(Ducha de mano masaje Ø 100 mm. (5 funciones) (1.34.748) con soporte orientable. Flexo SATIN (91.34.609.15)).

91.81.161.10 IA IB
 Cr | 1.81.164

91.81.161.10 IA IB
 Cr | 1.81.164.9

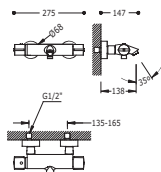

Bañera-ducha termostática

(Ducha de mano masaje Ø 100 mm. (5 funciones) (1.34.748) con soporte orientable. Flexo SATIN (91.34.609.15)).

91.81.161.10
 Cr | 1.81.174

91.81.161.10
 Cr | 1.81.174.9

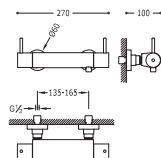

Ducha termostática

Ducha de mano anticalcárea (299.631.03) con soporte orientable y flexo SATIN (91.34.609.15). Indicado para personas con discapacidades físicas

299.195.09
 Cr | 090.264.01

299.195.09
 Cr | 090.964.01



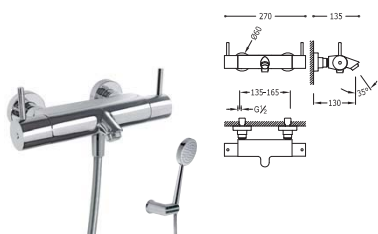

Bañera-ducha termostática

Ducha de mano anticalcárea (299.631.03) con soporte orientable y flexo SATIN (91.34.609). Indicado para personas con discapacidades físicas

299.195.09 REGRADA

Cr | **090.274.01** |

299.195.09 REGRADA

Cr | **090.974.01** |



Conjunto ducha termostática

- Ducha fija Ø 225 mm, con rótula. (299.632.01).
- Ducha móvil masaje Ø 100 mm. (5 funciones) (1.34.748).
- Flexo SATIN (91.34.609.15).
- Inversor integrado en el regulador de caudal.

91.81.161.10 REGRADA

Cr | **1.81.385** |



Conjunto ducha termostática

- Ducha fija Ø 250 mm, con rótula. (1.34.137.26).
- Ducha móvil masaje Ø 100 mm. (5 funciones) (1.34.748).
- Flexo SATIN (91.34.609.15).
- Barra telescópica.
- Inversor integrado en el regulador de caudal.

91.81.161.10 REGRADA

Cr | **1.90.214** |



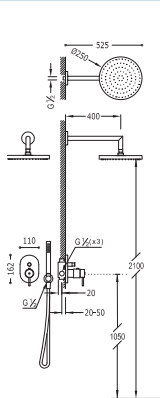

Kit de ducha termostático empotrado

con cierre y regulación de caudal (2 vías).

- Cuerpo empotrado incluido
- Ducha fija Ø 250 mm. con rótula. Material Latón (1.34.137.26).
- Soporte con toma pared (205.182.01).
- Ducha móvil anticalcárea (034.116.01).
- Flexo SATIN (91.34.609.15).



91.94.552

Cr 090.960.22

F





TRES SELECTION

FLAT-TRES

- 478 Lavabos
- 478 Bidé
- 478 Monomandos de superficie
- 479 Monomandos empotrados
- 480 Termostáticas de superficie
- 153 Accesorios



RECAMBIOS DE LOS ARTÍCULOS EN:
www.tresgriferia.com

LAVABOS

Ref:

Monomando lavabo

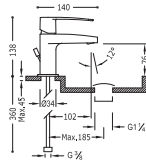

Cr 204.103.01



Cr 204.103.01.D

BIDÉ

Monomando bidé

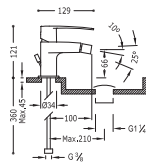

Cr 204.120.01



Cr 204.120.01.D

MONOMANDOS DE SUPERFICIE

Monomando ducha

Ducha de mano anticalcárea (1.34.617) con soporte orientable y flexo SATIN (91.34.609.15).

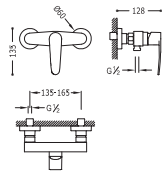

Cr 204.167.01

Monomando bañera-ducha

Ducha de mano anticalcárea (1.34.617) con soporte orientable y flexo SATIN (91.34.609).

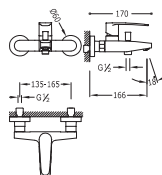

Cr 204.170.01

Monomando empotrar (1 vía)
cuerpo empotrado incluido



Cr | 204.177.01

Monomando empotrar (2 vías)
cuerpo empotrado incluido



Cr | 204.180.01

Kit de ducha monomando empotrado

- con cierre y regulación de caudal.
 · Cuerpo empotrado incluido
 · Ducha fija Ø 225 mm. con rótula. (299.632.01).
 · Soporte con toma pared (205.182.01).
 · Ducha móvil anticalcárea (1.34.617).
 · Flexo SATIN (91.34.609.15).

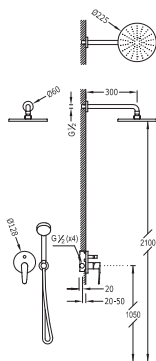

Cr | 204.180.02

Kit de ducha monomando empotrado

- con cierre y regulación de caudal.
 · Cuerpo empotrado incluido
 · Ducha fija Ø 225 mm. con rótula. (299.632.01).
 · Soporte con toma pared (205.182.01).
 · Ducha móvil anticalcárea (1.34.617).
 · Flexo SATIN (91.34.609.15).

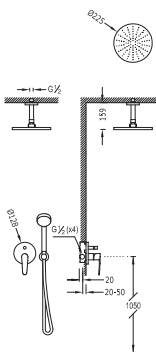

Cr | 204.180.80

TERMOSTÁTICAS DE SUPERFICIE

Ref:

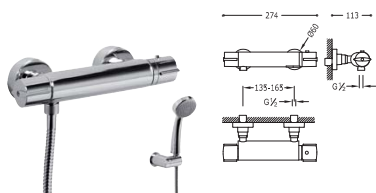

Ducha termostática

(Ducha de mano anticalcárea (1.34.617) con soporte orientable y flexo doble engatillado (91.34.828)).

299.195.08
Cr | 204.196.01

299.195.08
Cr | 204.196.03

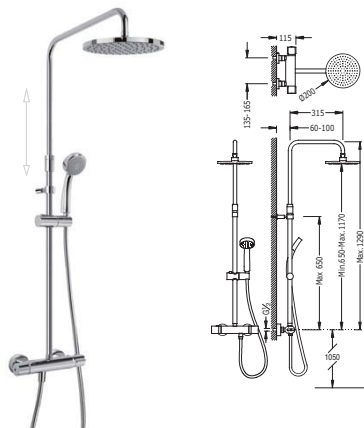

Conjunto ducha termostática

- Ducha fija Ø 200 mm. con rótula.
- Ducha anticalcárea Ø 80 mm. (1.34.617).
- Flexo SATIN (91.34.609.15).
- Barra telescópica.
- Inversor integrado en el regulador de caudal.

299.195.08
Cr | 204.387.03



Conjunto ducha termostática

- Ducha fija 200x200 mm. con rótula.
- Ducha anticalcárea 80x80 mm. (1.34.612).
- Flexo SATIN (91.34.609.15).
- Inversor integrado en el regulador de caudal.

299.195.08
Cr | 204.387.02



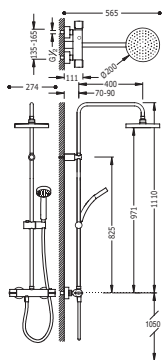

Conjunto ducha termostática

- Ducha fija Ø 200 mm. con rótula.
- Ducha anticalcárea Ø 80 mm. (1.34.617).
- Flexo SATIN (91.34.609.15).
- Inversor integrado en el regulador de caudal.



Cr | 204.387.01

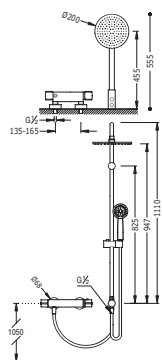

Conjunto ducha termostática

- Ducha fija Ø 200 mm. con rótula (299.632.12).
- Ducha anticalcárea Ø 80 mm. (1.34.617).
- Flexo SATIN (91.34.609.15).



Cr | 204.385.01



TRES SELECTION

K-TRES

- 484 Lavabos
- 485 Bidé
- 485 Monomandos de superficie
- 486 Monomandos empotrados
- 487 Bañeras de repisa
- 488 Termostáticas de superficie
- 153 Accesorios



RECAMBIOS DE LOS ARTÍCULOS EN:
www.tresgriferia.com

LAVABOS

Ref:

Monomando lavabo

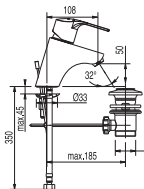

91.34.295.10 IA

Cr | 1.69.103



91.34.295.10 IA

Cr | 1.69.103.DA



Monomando lavabo

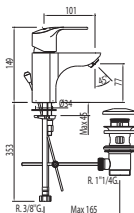

91.34.295.10

Cr | 069.103.02



91.34.295.10

Cr | 069.103.02.D



Monomando lavabo ecoeficiente

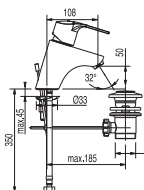

91.34.270.10

Cr | 1.69.104



91.34.270.10

Cr | 1.69.104.DA



Monomando lavabo

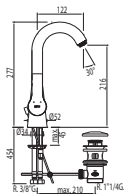

30° 91.34.288

Cr | 069.308.02.D

Monomando bidé

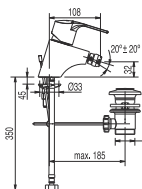

91.34.290 IA
Cr 1.69.120

91.34.290 IA
Cr 1.69.120.DA

Monomando bidé con duchita

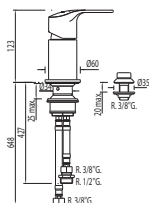

91.34.385.10
Cr 069.130.01

MONOMANDOS DE SUPERFICIE

Monomando ducha

Ducha de mano anticalcárea con soporte orientable. Flexo doble engatillado

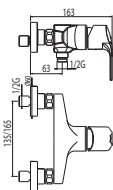

91.34.290 IA AERODUO
Cr 069.167.02

Monomando bañera-ducha

Ducha de mano anticalcárea con soporte orientable. Flexo doble engatillado

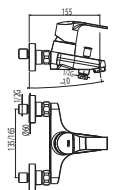

91.34.290 IIO/IA AERODUO
Cr 069.170.02

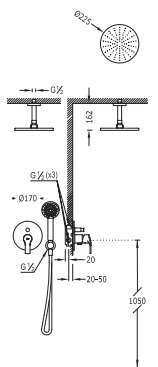

Kit de ducha monomando empotrado

- con cierre y regulación de caudal.
- Cuerpo empotrado incluido
 - Ducha fija Ø 225 mm. con rótula. (299.632.01)
 - Soporte con toma pared (205.182.01)
 - Ducha móvil masaje Ø 110 mm. (5 funciones).
 - Flexo SATIN (91.34.609.15).

91.34.290 **Cr 069.180.80**

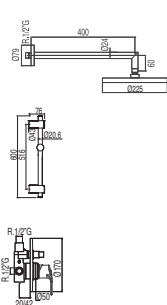

Kit de ducha monomando empotrado

- con cierre y regulación de caudal.
- Cuerpo empotrado incluido
 - Ducha fija Ø 225 mm. con rótula. (299.632.01)
 - Barra deslizante long. 516 mm.
 - Codo toma pared (205.183.01)
 - Ducha móvil masaje Ø 110 mm. (5 funciones).
 - Flexo SATIN (91.34.609.15).

91.34.290 **Cr 1.69.980**

BAÑERAS DE REPISA

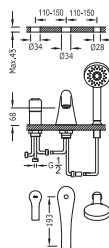

Monomando bañera de repisa

- Ducha móvil masaje Ø 110 mm. (5 funciones).
- Caudal: 3 bar – 15 l/m.

91.34.288 **Cr 1.69.145**

TERMOSTÁTICAS DE SUPERFICIE

Ref:

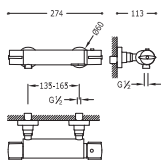

Ducha termostática

(Ducha de mano anticálcaria (1.34.617) con soporte orientable flexo doble engatillado (91.34.828)).

299.195.08 BELORA
 Cr 204.196.01

299.195.08 BELORA
 Cr 204.196.03

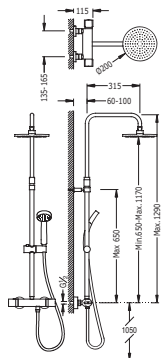

Conjunto ducha termostática

Ducha fija Ø 200 mm. con rétula.
 Ducha anticálcaria Ø 80 mm. (1.34.617).
 Flexo SATIN (91.34.609.15).
 Barra telescópica.
 Inversor integrado en el regulador de caudal.

299.195.08 BELORA
 Cr 204.387.03

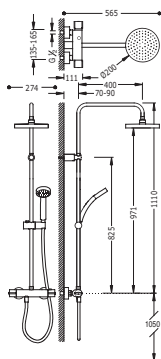

Conjunto ducha termostática

Ducha fija Ø 200 mm. con rétula.
 Ducha anticálcaria Ø 80 mm. (1.34.617).
 Flexo SATIN (91.34.609.15).
 Inversor integrado en el regulador de caudal.

299.195.08 BELORA
 Cr 204.387.01



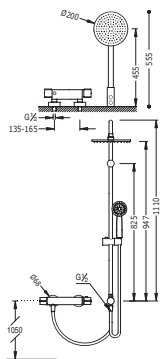

Conjunto ducha termostática

- Ducha fija Ø 200 mm. con rótula (299.632.12).
- Ducha anticalcárea Ø 80 mm. (1.34.617).
- Flexo SATIN (91.34.609.15).



Cr **204.385.01** |



TRES SELECTION

BM-TRES

- 492 Lavabos
- 493 Bidé
- 493 Monomandos de superficie
- 493 Monomandos empotrados
- 495 Bañeras de repisa
- 153 Accesorios



RECAMBIOS DE LOS ARTÍCULOS EN:
www.tresgriferia.com

LAVABOS

Ref:

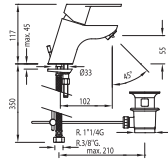

Monomando lavabo



91.34.295.10 IB

Cr | 1.39.102



91.34.295.10 IB

Cr | 1.39.102.DA

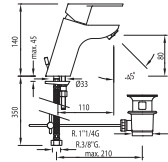

Monomando lavabo alto



91.34.295.10 IB

Cr | 1.39.103



91.34.295.10 IB

Cr | 1.39.103.DA

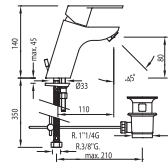

Monomando lavabo alto ecoeficiente



91.34.270.10

Cr | 1.39.104



91.34.270.10

Cr | 1.39.104.DA

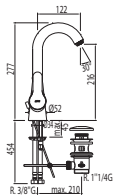

Monomando lavabo



881-91.34.303

Cr | 017.308.02.D

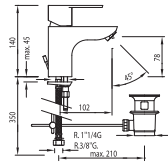

Monomando lavabo



91.34.295.10 IB

Cr | 1.17.103



91.34.295.10 IB

Cr | 1.17.103.DA

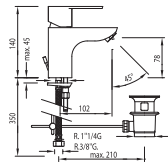

Monomando lavabo ecoeficiente



91.34.270.10

Cr | 1.17.104



91.34.270.10

Cr | 1.17.104.DA



BIDÉ

Ref:

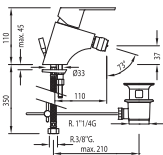

Monomando bidé

91.34.290 IA
Cr 1.39.120

91.34.290 IA
Cr 1.39.120.DA

MONOMANDOS DE SUPERFICIE

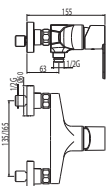

Monomando ducha

Ducha de mano anticalcárea con soporte orientable. Flexo doble engatillado

91.34.290 IIA
Cr 017.167.02

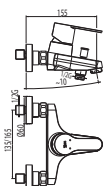

Monomando bañera-ducha

Ducha de mano anticalcárea con soporte orientable. Flexo doble engatillado

91.34.290 IIA
Cr 017.170.02

MONOMANDOS EMPOTRADOS

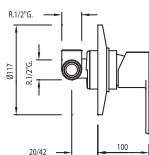

Monomando empotrar (1 vía)

cuerpo empotrado incluido

91.34.290
Cr 017.177.12

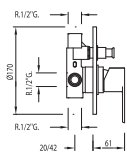

Monomando empotrar (2 vías)

cuerpo empotrado incluido

91.34.290
Cr 017.180.12



Kit de ducha monomando empotrado
 con cierre y regulación de caudal.
 - Cuerpo empotrado incluido
 - Ducha fija Ø 225 mm. con rótula. (299.632.01).

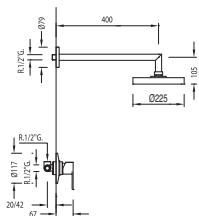

91.34.290

Cr | 1.17.377



Kit de ducha monomando empotrado
 con cierre y regulación de caudal.
 - Cuerpo empotrado incluido
 - Ducha fija Ø 225 mm. con rótula. (299.632.01).
 - Soporte con toma pared (205.182.01).
 - Ducha anticalcárea Ø 100 mm.
 - Flexo SATIN (91.34.609.15).

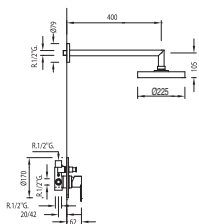

91.34.290



91141604

Cr | 1.17.175



Kit de ducha monomando empotrado
 con cierre y regulación de caudal.
 - Cuerpo empotrado incluido
 - Ducha fija Ø 225 mm. con rótula. (299.632.01).
 - Soporte con toma pared (205.182.01).
 - Ducha anticalcárea Ø 100 mm.
 - Flexo SATIN (91.34.609.15).

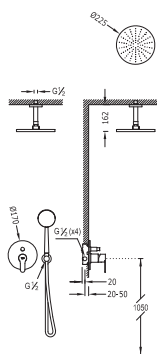

91.34.290



91141604

Cr | 017.180.80



Kit de ducha monomando empotrado

- con cierre y regulación de caudal.
- Cuerpo empotrado incluido
- Ducha fija Ø 225 mm. con rótula. (299.632.01).
- Barra deslizante long. 516 mm.
- Codo toma pared (205.183.01).
- Ducha anticalcárea Ø 100 mm.
- Flexo SATIN (91.34.609.15).

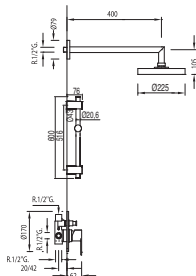

BAÑERAS DE REPISA

Monomando bañera de repisa

- Ducha anticalcárea.
- Caudal: 3 bar – 15 l/m.

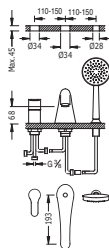





TRES SELECTION

MONOTRES 2000

- 498 Lavabos
- 498 Bidé
- 498 Monomandos de superficie
- 499 Monomandos empotrados
- 499 Bañeras de repisa
- 500 Cocinas
- 153 Accesorios



RECAMBIOS DE LOS ARTÍCULOS EN:
www.tresgriferia.com

LAVABOS

Ref:

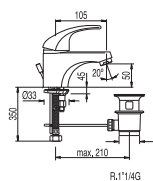

Monomando lavabo

91.34.290 IBB

Cr | 1.72.103

91.34.290 IBB

Cr | 1.77.103

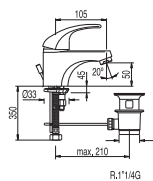

Monomando lavabo ecoeficiente

91.34.270.10

Cr | 1.72.104

91.34.270.10

Cr | 1.77.104



BIDÉ

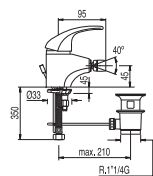

Monomando bidé

91.34.290 IBB

Cr | 1.72.120

91.34.290 IBB

Cr | 1.77.120

MONOMANDOS DE SUPERFICIE

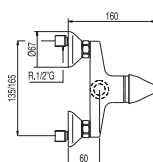

Monomando ducha

Ducha de mano anticálcaea con soporte orientable. Flexo doble engatillado

91.34.290 IIA 91.14444

Cr | 1.72.367

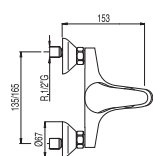

Monomando bañera-ducha

Ducha de mano anticálcaea con soporte orientable. Flexo doble engatillado

91.34.290 IID/A

Cr | 1.72.370

MONOMANDOS EMPOTRADOS

Ref:

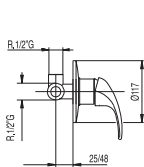

Monomando empotrar (1 vía)
cuerpo empotrado incluido



Cr 072.177.12

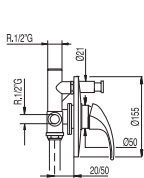

Monomando empotrar (2 vías)
cuerpo empotrado incluido



Cr 072.180.12

BAÑERAS DE REPISA

Monomando bañera de repisa
Ducha masaje. (3 funciones).
· Caudal: 3 bar - 15 l/m.

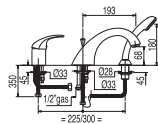

Cr 1.72.145



COCINAS

Ref:

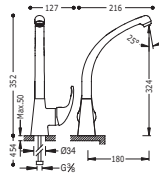

Monomando fregadero vertical



Cr | 1.72.447

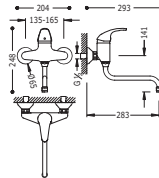

Monomando fregadero pared



Cr | 1.72.317

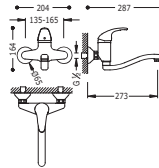

Monomando fregadero pared



Cr | 1.72.318

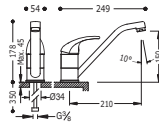

Monomando fregadero vertical



Cr | 1.72.333

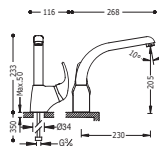

Monomando fregadero vertical



Cr | 1.72.440



BI | 4.72.440

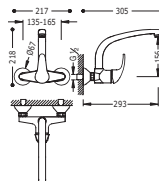

Monomando fregadero pared



Cr | 1.72.420

Ref.:



Monomando fregadero pared



Cr 1.72.418



Monomando fregadero pared



Cr 1.72.218

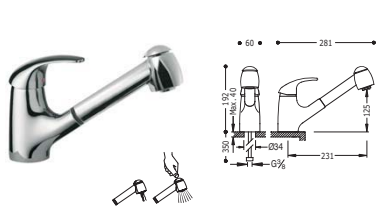

Monomando fregadero vertical
con ducha extraíble (2 funciones)



Cr 1.72.443





TRES SELECTION

ECO-TRES

- 504 Lavabos
- 504 Bidé
- 505 Monomandos de superficie
- 505 Monomandos empotrados
- 507 Bañeras de repisa
- 507 Cocinas
- 153 Accesorios



RECAMBIOS DE LOS ARTÍCULOS EN:
www.tresgriferia.com

LAVABOS

Ref:

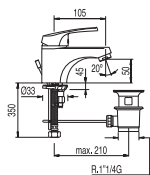

Monomando lavabo

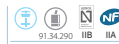

Cr | 1.70.103.02



Cr | 1.75.103.02

Monomando lavabo ecoeficiente

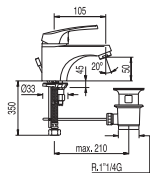

Cr | 1.70.104.02



Cr | 1.75.104.02

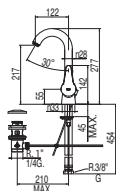

Monomando lavabo



Cr | 1.75.308.02

BIDÉ

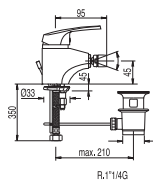

Monomando bidé



Cr | 1.70.120.02



Cr | 1.75.120.02

MONOMANDOS DE SUPERFICIE

Ref.:

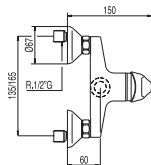

Monomando ducha

Ducha de mano anticalcárea con soporte orientable. Flexo doble engatillado

91.34.290 IIA IA REGULADA
 Cr | 1.70.167.02

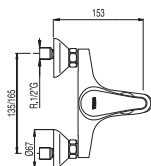

Monomando bañera-ducha

Ducha de mano anticalcárea con soporte orientable. Flexo doble engatillado

91.34.290 IID/A IIC/A REGULADA
 Cr | 1.70.170.02

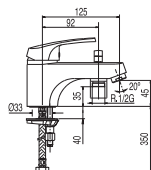

Monomando bañera

91.34.290 IID/A REGULADA
 Cr | 1.70.173.02

MONOMANDOS EMPOTRADOS

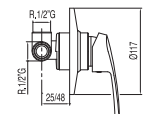

Monomando empotrar (1 vía)

cuerpo empotrado incluido

91.34.290 REGULADA
 Cr | 070.177.02.12

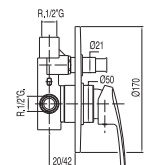

Monomando empotrar (2 vías)

cuerpo empotrado incluido

91.34.290 REGULADA
 Cr | 070.180.02.12



Kit de ducha monomando empotrado

- con cierre y regulación de caudal.
- Cuerpo empotrado incluido
- Barra deslizante long. 516 mm.
- Codo toma pared.
- Ducha móvil masaje Ø 80 mm. (2 funciones).
- Flexo SATIN (91.34.609.15).

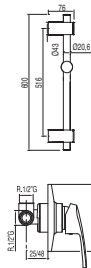

91.34.290 BELARUBA
Cr | 1.70.970.02



Kit de ducha monomando empotrado

- con cierre y regulación de caudal.
- Cuerpo empotrado incluido
- Ducha fija Ø 225 mm. con rótula. (299.632.01).
- Ducha móvil masaje Ø 80 mm. (2 funciones).
- Flexo SATIN (91.34.609.15).

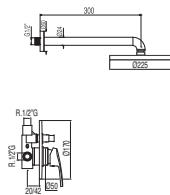

91.34.290 BELARUBA
Cr | 070.990.02



Kit de ducha monomando empotrado

- con cierre y regulación de caudal.
- Cuerpo empotrado incluido
- Ducha fija Ø 225 mm. con rótula. (299.632.01).
- Barra deslizante long. 516 mm.
- Codo toma pared (205.183.01).
- Ducha móvil masaje Ø 80 mm. (2 funciones).
- Flexo SATIN (91.34.609.15).

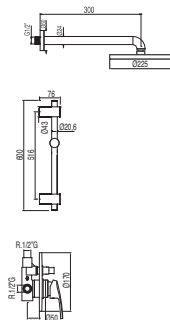

91.34.290 BELARUBA
Cr | 1.70.980.02



Kit de ducha monomando empotrado

- Ducha fija Ø 200 mm. con rótula (299.632.12).
- Codo toma pared.
- Ducha anticalcárea Ø 80 mm.
- Flexo doble engatillado

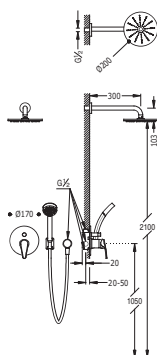

91.34.290
Cr | **070.880.02**

BAÑERAS DE REPISA



Monomando bañera de repisa

- Ducha masaje. (3 funciones).
- Caudal: 3 bar - 15 l/m.

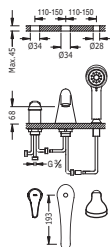

91.34.288
Cr | **070.145.02**

COCINAS



Monomando fregadero vertical

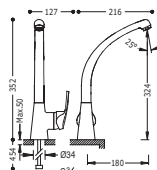

91.34.288
Cr | **1.70.447.02**

Ref: |

Monomando fregadero vertical

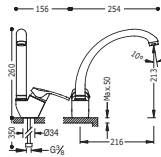
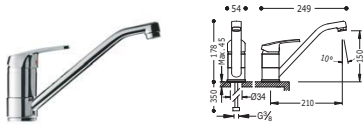

Monomando fregadero vertical

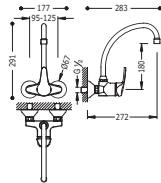

Monomando fregadero pared

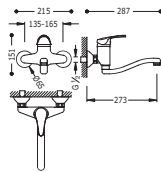

Monomando fregadero pared

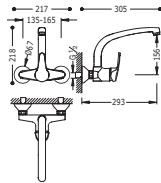

Monomando fregadero pared

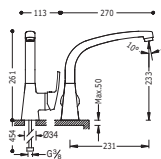

Monomando fregadero vertical



Monomando fregadero vertical

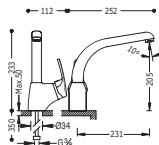

Cr 1.70.440.02





TRES SELECTION

ESE-23

- 512 Lavabos bimando
- 512 Bidé
- 513 Bimandos de superficie
- 513 Cocinas
- 153 Accesorios

RECAMBIOS DE LOS ARTÍCULOS EN:
www.tresgriferia.com

BIMANDO LAVABOS

Ref:

Grifo lavabo

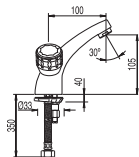

91.34.284

Cr | 1.23.103

Grifo lavabo

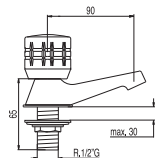

91.34.284

Cr | 1.23.100.F



91.34.284

Cr | 1.23.100.C

Batería lavabo

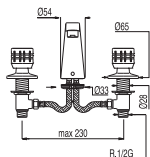

91.34.285

Cr | 1.23.105

Grifo lateral

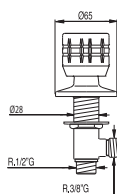

91.34.285

Cr | 1.23.510.F



91.34.285

Cr | 1.23.510.C

BIDÉ

Grifo bidé

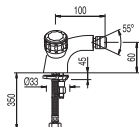

91.34.284

Cr | 1.23.120

Grifo bidé de 1/2"

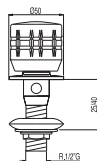

91.34.284

Cr | 1.23.125.F |



91.34.284

Cr | 1.23.125.C |

BIMANDO BAÑO

Grupo ducha

Ducha de mano anticalcárea con soporte orientable. Flexo doble engatillado

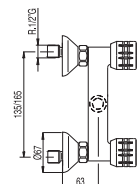

91.34.284

Cr | 1.23.167 |

Grupo baño-ducha

Ducha de mano anticalcárea con soporte orientable. Flexo doble engatillado

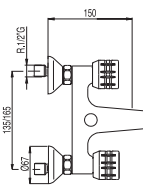

91.34.284

Cr | 1.23.170 |

COCINAS

Grupo fregadero pared

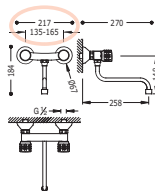

Cr | 1.23.310 |

Grupo fregadero pared

Distancia a pared de 260 mm.

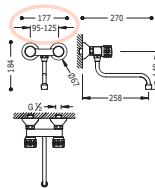

Cr | 1.23.210 |

Ref:

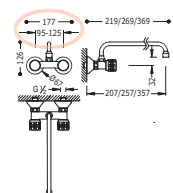

Grupo fregadero pared

Cr | **1.23.214** |

Cr | **1.23.215** |

Cr | **1.23.220** |

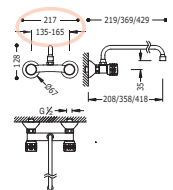

Grupo fregadero pared

Cr | **1.23.314** |

Cr | **1.23.330** |

Cr | **1.23.360** |

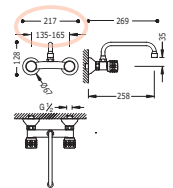

Grupo fregadero pared

Cr | **1.23.315** |

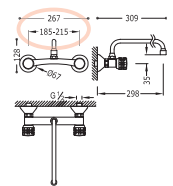

Grupo fregadero pared

Cr | **1.23.416** |

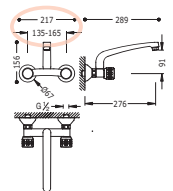

Grupo fregadero pared

Cr | **1.23.317** |

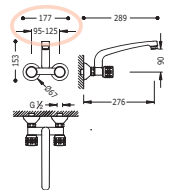

Grupo fregadero pared

Cr | **1.23.217** |

VARIOS

Ref:

Grifo fregadero

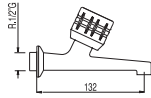

F 91.34.283

Cr | 1.23.520.F

C 91.34.283

Cr | 1.23.520.C

Grifo fregadero

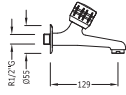

F 91.34.283

Cr | 023.520.01.F

C 91.34.283

Cr | 023.520.01.C

Grifo lavadora
De 1/2" - 3/4"

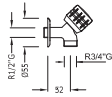

F 91.34.283

Cr | 1.23.500.F

C 91.34.283

Cr | 1.23.500.C

Llave de paso empotrar

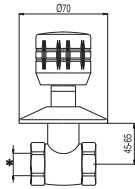

F 91.34.286 (1/2")

Cr | 1.23.155.F

F 91.34.286 (Ø 15 mm.)

Cr | 1.23.511.F

F 91.34.286 (Ø 18 mm.)

Cr | 1.23.512.F

F 91.34.287 (Ø 22 mm.)

Cr | 1.23.513.F

Llave de paso empotrar

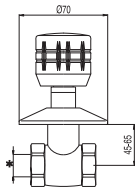

C 91.34.286 (1/2")

Cr | 1.23.155.C

C 91.34.286 (Ø 15 mm.)

Cr | 1.23.511.C

C 91.34.286 (Ø 18 mm.)

Cr | 1.23.512.C

C 91.34.287 (Ø 22 mm.)

Cr | 1.23.513.C

Ref:

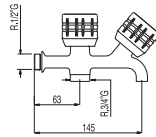

Grifo lavadora doble
De 1/2" - 3/4"



Cr | 1.23.515

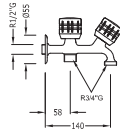

Grifo lavadora doble
1/2" - 3/4" - 3/4"



Cr | 023.515.01

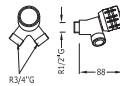

Grifo doble
De 1/2" - 3/4"



Cr | 023.516.01

LLAVES DE PASO

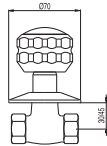

Llave de paso rosca
1/2"



Cr | 1.33.155.10.F



Cr | 1.33.155.10.C

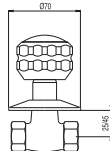

Llave de paso rosca
3/4"



Cr | 1.33.157.10.F



Cr | 1.33.157.10.C

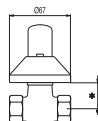

Llave de paso regulación oculta

91.34.296 1/2" 20/55
Cr | 1.33.516

91.34.297 3/4" 20/60
Cr | 1.33.517

91.34.298 1" 30/70
Cr | 1.33.518



TRES SELECTION

COCINA

- 520 Monomando
- 525 Con caño extraíble
- 527 Para tratamiento de agua
- 528 Industrial
- 530 Mural



RECAMBIOS DE LOS ARTÍCULOS EN:
www.tresgriferia.com

COCINAS PARA DISFRUTAR

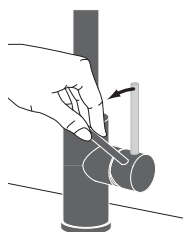

Maneta con rotación frontal. Evita que la maneta choque contra la pared.

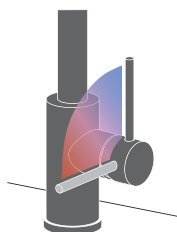

Ahorro energético Cold-Tres. El grifo se abre siempre en agua fría, evitando el encendido innecesario del calentador.

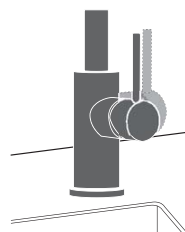

Instalación variable. La posición del monomando se puede instalar a la derecha o central según las necesidades personales.



Alturas de confort. Los caños con diferentes alturas son ideales para encimeras especiales.

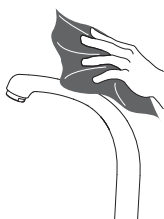

Cromado para toda la vida. El cromado TRES-MICRON® es duradero y fácil de limpiar.

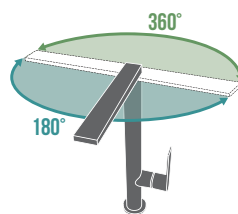

Caño giratorio. Según modelos, caños de giro limitado a 180° o bien completa libertad de movimiento a 360°.



COCINA MONOMANDO

Ref.:

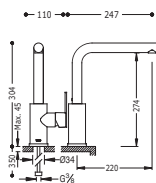

Monomando fregadero vertical



0.35 360° 91.34.592
Cr | 1.81.436

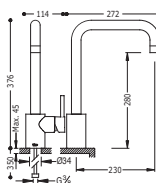

Monomando fregadero vertical



0.35 360° 91.34.290
Cr | 1.62.441

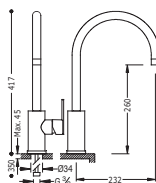

Monomando fregadero vertical



0.35 360° 91.34.592
Cr | 1.81.540

Ref:

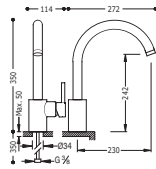

Monomando fregadero vertical



Cr | 1.62.442

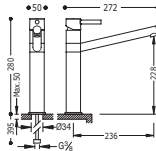

Monomando fregadero vertical
caño largo



Cr | 1.83.333

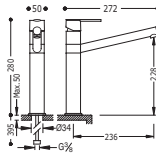

Monomando fregadero vertical
caño largo



Cr | 1.81.333

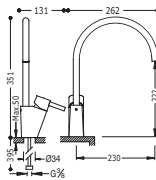

Monomando fregadero vertical



Cr | 1.83.341

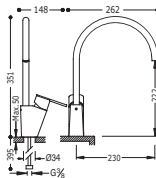

Monomando fregadero vertical



Cr | 1.81.341

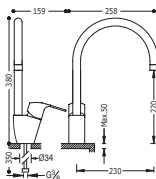

Monomando fregadero vertical



Cr | 1.69.440

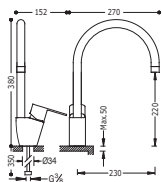

Monomando fregadero vertical



Cr | 1.17.440

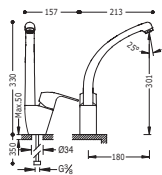

Monomando fregadero vertical



Cr | 069.440.01

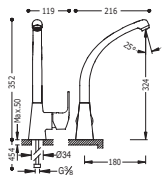

Monomando fregadero vertical



Cr | 069.447.01

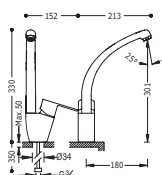

Monomando fregadero vertical



Cr | 017.440.01

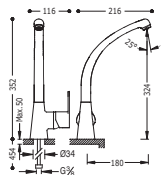

Monomando fregadero vertical



Cr | 017.447.02

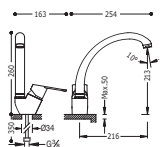

Monomando fregadero vertical



Cr | 1.39.441

Ref: |

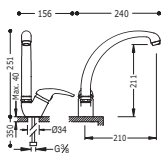

Monomando fregadero vertical



Cr | 1.30.338 |

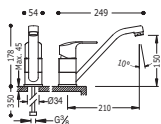

Monomando fregadero vertical



Cr | 1.69.333 |

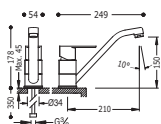

Monomando fregadero vertical



Cr | 1.17.333 |

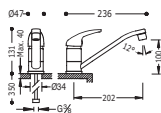

Monomando fregadero vertical



Cr | 1.30.337 |

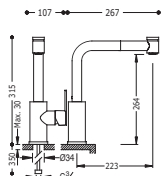

Monomando fregadero vertical con ducha extraíble (2 funciones)

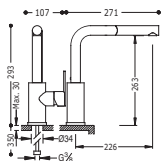

Monomando fregadero vertical con ducha extraíble

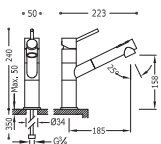

Monomando fregadero vertical con ducha extraíble (2 funciones)

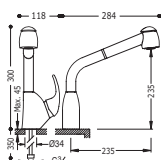

Monomando fregadero vertical con ducha extraíble (2 funciones)

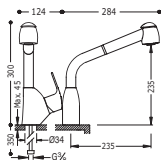

Monomando fregadero vertical con ducha extraíble (2 funciones)

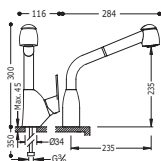

Monomando fregadero vertical con ducha extraíble (2 funciones)



AGUA FILTRADA SIN CLORO

Cada día son más los hogares que utilizan agua del grifo para cocinar y beber. En muchos casos el sabor y el olor del agua es lo que hace que a la gente beba o no agua del grifo. Por ello es habitual la colocación de un filtro instalado debajo de la encimera que purifique, trate o simplemente filtre el agua.



FILTRO ANTICLORO DE TRES

Según los estudios realizados, el agua osmotizada es excesivamente baja en minerales, razón por la cual no es recomendable para su consumo diario.

El FILTRO ANTICLORO de TRES asegura un índice bajo en cloro, eliminando el mal sabor de agua pero respetando las propiedades minerales del agua de red.

El cierre está incorporado justo en la salida del agua, eliminando el contacto del agua con el aire y evitando así su contaminación.



Cada grifo tiene la opción de venderse con el filtro anticloro de TRES (incluido) o adaptado para instalar un sistema osmosis (la instalación osmótica no está incluida).



COCINA INDUSTRIAL

Ref:

Monomando fregadero vertical
Ducha de dos posiciones

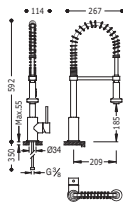

Cr | 1.30.493

Monomando fregadero vertical
Ducha de dos posiciones

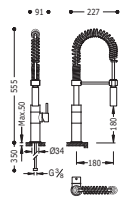

Cr | 1.30.485

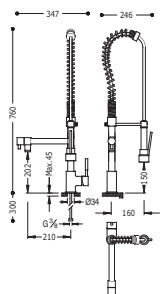

Monomando fregadero vertical



Cr 1.30.495

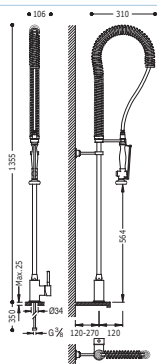

Monomando fregadero vertical



Cr/Bi 1.30.484

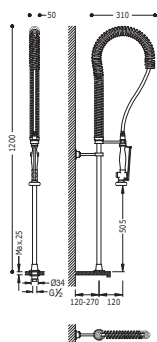

Fregadero vertical



Cr/Bi 1.30.481

Grifo de pedal

Mezclador. Presionando el pedal aumenta progresivamente la temperatura del agua, siempre con un caudal constante.

Monomando empotrar de repisa



Cr 1.12.370

Cr 1.34.161

Grifo de pedal

Un agua. Presionando el pedal aumenta progresivamente el caudal.

Monomando empotrar



Cr 1.12.360



REINER

Cr 017.177.12



COCINA MURAL

Ref:

Monomando mural

Cuerpo empotrado incluido e indivisible.

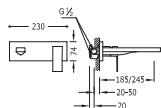

91.30.190 (185 mm.)
Cr 006.200.03

91.30.190 (245 mm.)
Cr 006.200.04

Monomando mural

Cuerpo empotrado incluido e indivisible.

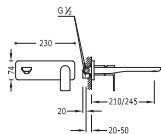

91.30.190 (210 mm.)
Cr 200.200.03

91.30.190 (245 mm.)
Cr 200.200.02

Monomando mural

Cuerpo empotrado incluido e indivisible.

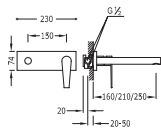

91.30.190 (210 mm.)
Cr 205.200.41

91.30.190 (250 mm.)
Cr 205.200.01

Monomando mural

Cuerpo empotrado incluido e indivisible.

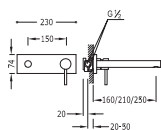

91.34.592 (210 mm.)
Cr 062.200.02

91.34.592 (250 mm.)
Cr 1.62.200

Ref:

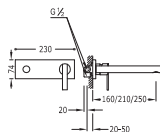

Monomando mural

Cuerpo empotrado incluido e indivisible.



Cr | **081.200.21**



Cr | **1.81.200**

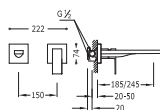

Monomando mural

Cuerpo empotrado incluido e indivisible.



Cr | **006.200.12**



Cr | **006.200.11**

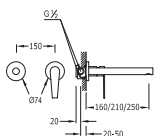

Monomando mural

Cuerpo empotrado incluido e indivisible.



Cr | **205.200.71**



Cr | **205.200.02**

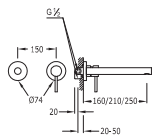

Monomando mural

Cuerpo empotrado incluido e indivisible.



Cr | **062.200.71**



Cr | **062.200.03**

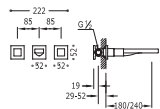

Bimando mural

Cuerpo empotrado incluido e indivisible.



Cr | **008.153.01**



Cr | **008.154.01**

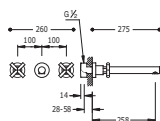

Bimando mural

Cuerpo empotrado incluido e indivisible.



Cr | **1.63.151**



TRES SELECTION

TEMPORIZADAS Y ELECTRÓNICAS

- 534 Lavabos
- 538 Grifos para urinario
- 539 Grifos de ducha
- 541 Cocinas

RECAMBIOS DE LOS ARTÍCULOS EN:
www.tresgriferia.com



GRIFO TEMPORIZADO PARA LAVABO

Ref:

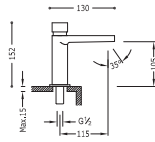

Lavabo temporizado 1 agua
Cierre automático: 6 seg.



299.396.01 6" 
Cr | 205.112.01 |

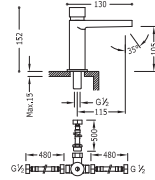

Lavabo temporizado mezclador
Cierre automático: 6 seg. NOTA: Incluye un grifo mezclador dos aguas con tubos flexibles (ref: 1.92.507.30).



299.396.01 6" 
Cr | 205.112.02 |

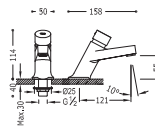

Lavabo temporizado 1 agua
Cierre automático: 6 seg.



299.396.01 6" 
Cr | 012.103.03 |

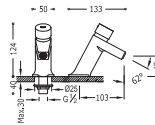

Lavabo temporizado 1 agua
Cierre automático: 6 seg.



299.396.01 6" 
Cr | 012.103.02 |

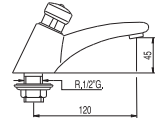

Grifo lavabo encimera
entrada tubo 10x12. Cierre automático: 15 seg. Caudal: 6,5 l/min.



15" 
Cr | 1.12.103 |

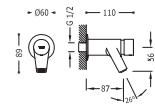

Grifo lavabo mural
rosca macho 1/2" G. Cierre automático: 6 seg. Caudal: 6,5 l/min.



299.396.01 6" 
Cr | 012.100.02 |

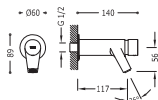

Grifo lavabo mural

rosca macho 1/2" G. Cierre automático: 6 seg. Caudal: 6,5 l/min.



Cr | 012.100.03

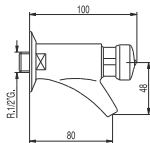

Grifo lavabo mural

rosca macho 1/2" G. Cierre automático: 15 seg. Caudal: 6,5 l/min.



Cr | 1.12.100



GRIFO ELECTRÓNICO PARA LAVABO

Ref:

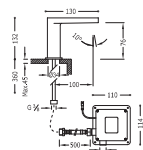

Lavabo electrónico 1 agua
Accionado mediante sensor de infrarrojos



Cr | 205.603.01

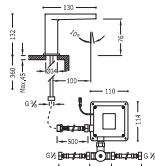

Lavabo electrónico mezclador
Accionado mediante sensor de infrarrojos. NOTA: Incluye un grifo mezclador dos aguas con tubos flexibles (ref:1.92.507.30).



Cr | 205.603.02

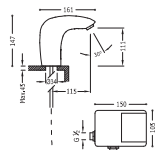

Lavabo electrónico 1 agua
Accionado mediante sensor de infrarrojos



Cr | 1.92.606.03

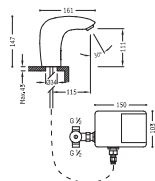

Lavabo electrónico mezclador
Accionado mediante sensor de infrarrojos.



Cr | 1.92.906.03

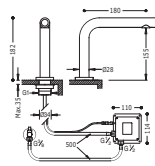

Lavabo electrónico 1 agua TOUCH-TRES
Sistema sensible al tacto. Sólo tocar (NO pulsar)



Cr | 061.447.01

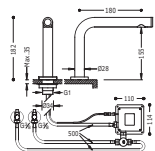

Lavabo electrónico mezclador TOUCH-TRES
Sistema sensible al tacto. Sólo tocar (NO pulsar). NOTA: Incluye un grifo mezclador dos aguas con tubos flexibles (ref: 1.92.507.30).



Cr | 061.448.01

Ref.:

Mezclador dos aguas CON TUBOS FLEXIBLES
para lavabos TRESTRONIC, TOUCH-TRES y TEMPO-TRES

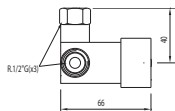

Cr 1.92.507.30

Lavabo electrónico 1 agua

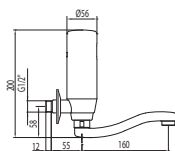

Cr 092.171.01



GRIFO TEMPORIZADO PARA URINARIO

Ref.:

Grifo de urinario

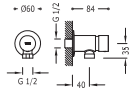

Cr 012.200.02

Grifo de urinario

entrada posterior, rosca macho 1/2" G. Salida con tuerca y junta para tubo 10x12. Caudal: 16 l/min.

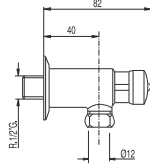

Cr 1.12.200

Grifo de urinario para empotrar
rosca macho 1/2" G.

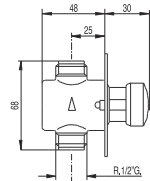

Cr 012.208.01

Fluxor para inodoros

entrada rosca macho 3/4" G. Salida para tubo 26x28. Caudal: 1,5 l/seg.

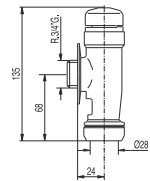

Cr 1.12.205

GRIFO ELECTRÓNICO PARA URINARIO

Grifo electrónico visto para urinario
Con dos tubos adaptables a urinario

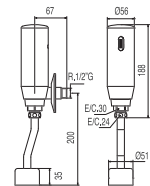

Cr 1.12.206

Grifo electrónico empotrado para urinario

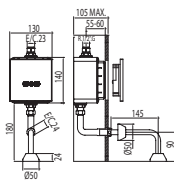

Cr 012.207.01

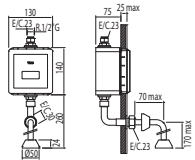

Grifo electrónico empotrado para urinario



Cr | 1.12.207

GRIFO TEMPORIZADO PARA DUCHA

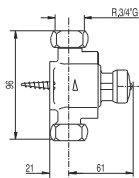

Grifo de ducha

alimentación exterior por parte inferior, entrada y salida con tuerca y junta para tubo 13x15. Cierre automático: 15 seg. Caudal: 16 l/min.



Cr | 1.12.167

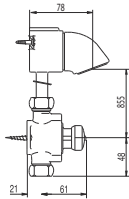

Conjunto de ducha grifo más rociador

alimentación exterior por parte inferior, con tuerca y junta para tubo 13x15 y regulador automático de caudal incorporado: 16 l/min.



Cr | 1.12.161

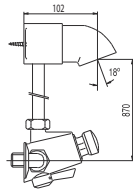

Conjunto mezclador para ducha

Entradas opuestas con racores extensibles. Regulador automático de caudal incorporado en el rociador. Válvulas antirretorno en las entradas. Caudal: 16 l/min.



Cr | 1.12.163

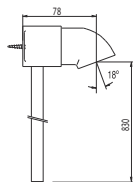

Rociador + tubo

Caudal: 6 l/min.



Cr | 1.12.161.50



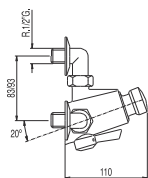

Grifo mezclador para ducha

Entradas opuestas y salida vertical. Equipado con 3 racores extensibles. Válvulas antirretorno en las entradas. Caudal: 16 l/min.



Cr | 1.12.162 |

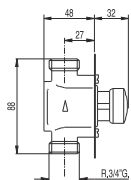

Grifo de ducha para empotrar

entrada y salida con rosca macho 3/4" G. Caudal: 20 l/min.



Cr | 1.12.178 |

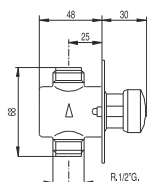

Grifo de ducha para empotrar

entrada y salida con rosca macho 1/2" G. Caudal: 16 l/min.



Cr | 1.12.177 |

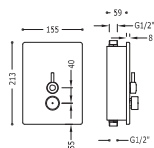

Grifo mezclador para ducha

con 2 entradas de agua



Cr | 012.179.01 |

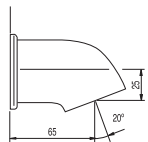

Rociador antivandálico

con regulador automático de caudal: 6 l/min.



Cr | 1.34.168.03 |

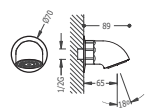

Rociador para ducha

con regulador automático de caudal. Rosca 1/2" G.



Cr | 1.34.167.03 |

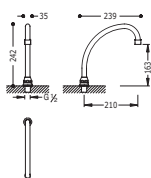

Caño fregadero
con enlace



Cr | 1.12.441

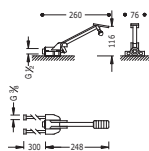

Grifo de pedal

Mezclador. Presionando el pedal aumenta progresivamente la temperatura del agua, siempre con un caudal constante.

Cr | 1.12.370

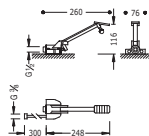

Grifo de pedal

Un agua. Presionando el pedal aumenta progresivamente el caudal.

Cr | 1.12.360







TRES SELECTION

GRIFERÍA ESPECIAL

- 544 Bidé
- 548 Medicales
- 549 Peluquería
- 549 Cocina
- 550 Jardín - Piscina
- 551 Vino



RECAMBIOS DE LOS ARTÍCULOS EN:
www.tresgriferia.com

SUSTITUYA EL BIDÉ Y APROVECHE ESPACIO

Aprovecha el espacio del baño ya que se sustituye el bidé tradicional por un grifo que aprovecha el recipiente del váter.

Instalación sencilla en poco espacio.

El sistema Protec-tres® permite la elección de la posición máxima de apertura de la palanca en agua caliente, evitando posibles quemaduras.



SOLUCIÓN SIN OBRAS

- Monomando especial de lavabo con una salida específica para la ducha/bidé.
- Instalación sencilla utilizando la toma de agua compartida con el monomando de lavabo.
- Ducha de mano con cierre y válvula antirretorno. Flexo SATIN.



SOLUCIÓN CON OBRAS

- Monomando mezclador empotrado con soporte de ducha/bidé integrado.
- Diseños cuadrado o redondo, con distintos modelos de maneta. Cada modelo dispone de la opción para paredes de pladur.
- El soporte de la ducha de mano puede ir a la izquierda o a la derecha.
- La ducha de mano es de latón con racor limitador 5 l/min. Con sistema antigoteo. Flexo SATIN.
- Se puede acoplar un accesorio para toallas disponible en diseño cuadrado y redondo (se vende por separado).



BIDÉ

Ref:

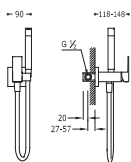

Monomando mezclador empotrar para bidé WC

Soporte derecha o izquierda, cambiabile. Ducha de latón con racor limitador 5 l/m. Antigoteo y flexo SATIN. * Opción para paredes de Pladur



91.30.190	REGRABADA
Cr	006.123.01
Cr	006.123.02*



Accesorio porta toallas

180 mm. (para ref.: 006.123.01, 006.123.02). * NOTA: Soporte derecha o izquierda, cambiabile.

Cr	034.124.02
----	------------

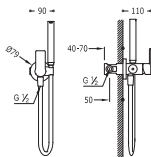

Monomando mezclador empotrar para bidé WC

Soporte derecha o izquierda, cambiabile. Ducha de latón con racor limitador 5 l/m. Antigoteo y flexo SATIN. * Opción para paredes de Pladur



91.34.591	REGRABADA
Cr	205.223.01
Cr	205.222.01*

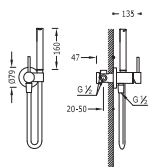

Monomando mezclador empotrar para bidé WC

Soporte derecha o izquierda, cambiabile. Ducha de latón con racor limitador 5 l/m. Antigoteo y flexo SATIN. * Opción para paredes de Pladur



91.34.591	REGRABADA
Cr	1.34.123
Cr	1.34.122*

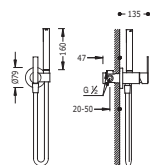

Monomando mezclador empotrar para bidé WC

Soporte derecha o izquierda, cambiabile. Ducha de latón con racor limitador 5 l/m. Antigoteo y flexo SATIN. * Opción para paredes de Pladur



91.34.591	REGRABADA
Cr	1.81.223
Cr	1.81.222*



Accesorio porta toallas

180 mm. (para ref.: 1.34.122, 1.34.123, 1.81.122, 1.81.123, 1.81.222, 1.81.223, 205.222.01, 205.223.01). * NOTA: Soporte derecha o izquierda, cambiabile.

Cr	034.124.01
----	------------

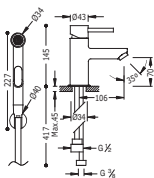

Monomando lavabo para bidé WC
Duchita con cierre y flexo SATIN

91.34.592.10 BELGARA
Cr | **1.62.113**

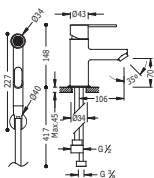

Monomando lavabo para WC
Duchita con cierre y flexo SATIN

91.34.592.10 BELGARA
Cr | **1.81.113**

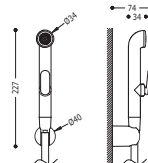

Kit ducha para bidé WC
Duchita con cierre, flexo SATIN y soporte fijo pared.

Cr | **299.950.01**

SUSTITUYA EL BIDÉ
APROVECHANDO
ESPACIO EN EL BAÑO



MEDICALES

Ref:

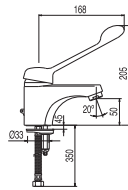

Monomando lavabo con palanca medical



91.34.290

Cr | 1.70.103.02.11 |

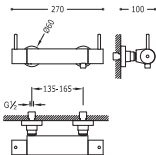

Ducha termostática

Ducha de mano anticalcárea (299.631.03) con soporte orientable y flexo SATIN (91.34.609.15). Indicado para personas con discapacidades físicas



299.195.09

Cr | 090.264.01 |



299.195.09

Cr | 090.964.01 |

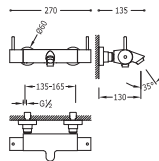

Bañera-ducha termostática

Ducha de mano anticalcárea (299.631.03) con soporte orientable y flexo SATIN (91.34.609). Indicado para personas con discapacidades físicas



299.195.09

Cr | 090.274.01 |



299.195.09

Cr | 090.974.01 |

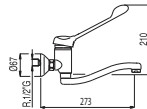

Monomando fregadero pared con palanca medical



112-163 301 91.34.290

Cr | 1.72.318.11 |

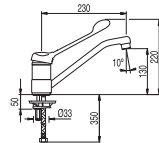

Monomando fregadero vertical con palanca medical



301 91.34.298

Cr | 1.72.333.11 |

Palanca medical monomando
(para ref.: ECO-TRES, MONOTRES 2000)

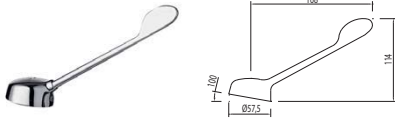

Cr | 91.34.011 |

PELUQUERIA

Monomando peluquería



91.34.288
Cr | 1.72.450 |

COCINA

Caño fregadero



Cr | 1.12.441 |

Grifo de pedal

Mezclador. Presionando el pedal aumenta progresivamente la temperatura del agua, siempre con un caudal constante.

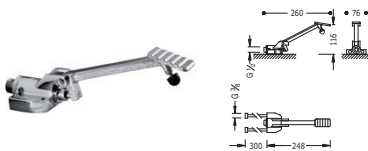

Cr | 1.12.370 |

Grifo de pedal

Un agua. Presionando el pedal aumenta progresivamente el caudal.



Cr | 1.12.360 |

JARDÍN - PISCINA

Ref:

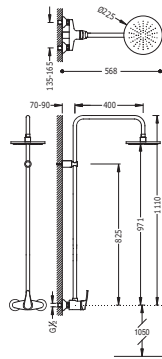

Ducha de jardín o piscina
Monomando de agua fría y caliente



Cr 070.995.01

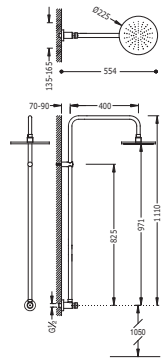

Ducha de jardín o piscina
Temporizada de 1 agua

Cr 012.996.01

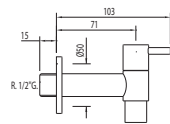

Grifo jardín
con aireador

Cr 034.501.01

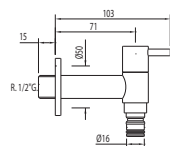

Grifo jardín
para manguera

Cr 034.501.02

VINO

Ref:

Grifo de vino Nº 5

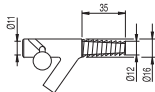

Cr 0.05.010

Grifo de vino Nº 1/C

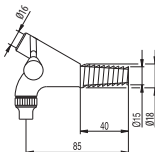

Cr 0.01.010

Grifo de vino Nº 2/C

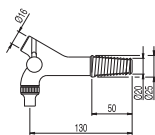

Cr 0.02.010

Grifo de vino Nº 3/C

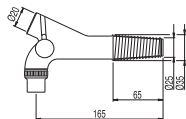

Cr 0.03.010

Grifo de vino Nº 1/N

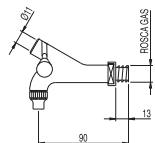

(3/8" G.)
Cr 0.01.000

(1/2" G.)
Cr 0.01.001

Grifo de vino Nº 2/N

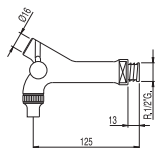

Cr 0.02.000

Grifo de vino Nº 3/N

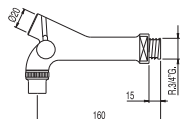

Cr 0.03.000



TRES SELECTION

PROGRAMA DE DUCHAS

- 557 Barras deslizantes
- 561 Kits de ducha
- 566 Kits de ducha de gran formato
- 575 Duchas de mano
- 578 Brazos de ducha
- 580 Jets
- 582 Flexos
- 584 Soportes con toma pared y orientables
- 586 Codo adaptador

RECAMBIOS DE LOS ARTÍCULOS EN:
www.tresgriferia.com

VENTAJAS EN LA DUCHA



BARRAS DE DUCHA



Sujeción regulable

Sistema de sujeción a pared deslizante para aprovechar posibles orificios existentes.



Toma de agua

Inteligente solución de cómo llevar el agua sin la necesidad de más obras.



Soporte orientable

Y con altura regulable deslizándose por la barra.

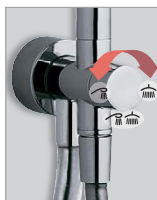

Inversor integrado

Invierte la salida de agua entre la ducha de mano, el rociador o ambas simultáneamente.

DUCHAS DE MANO



Sistema anticalcáreo

Boquillas de silicona que evitan la incrustación de cal. Fácil de limpiar con el dedo.

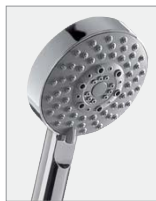

Distintas funciones

De una a cinco funciones: chorros masajeantes, estimulantes, efecto lluvia...

FLEXOS

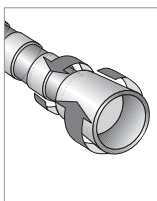

Giratorio antitorción

Sistema antitorción que permite un giro de 360° de la ducha evitando la torcedura del flexo.



Acabado SATIN

La cubierta exterior es de material sintético con apariencia cromada. Higiénico y fácil de limpiar.



Toma universal

La toma estándar 1/2" se adapta a todos los tipos de duchas, soportes y grifería.



Flexo doble engatillado

Este flexo altamente resistente evita, en caso de rotura, la aparición de aristas cortantes.



Flexo Inox extensible

Material metálico cromado de alta calidad con la capacidad de extenderse de 1,70 a 2,00 m.



BARRAS DESLIZANTES

Ref.:

Barra deslizante PROJECT
 Latón long. 659 mm.
 Latón long. 909 mm.

Barra deslizante CUADRO-SLIM
 Latón long. 663 mm.
 Latón long. 900 mm.

Barra deslizante CUADRO
 Latón long. 842 mm.

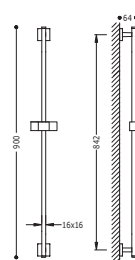
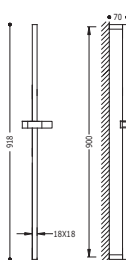
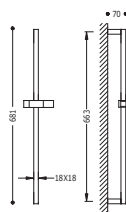
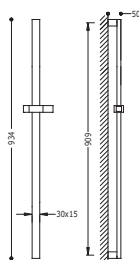
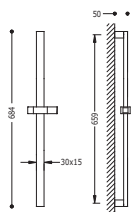

	(659 mm.)	
Cr	1.34.516	
	(909 mm.)	
Cr	1.34.517	

	(663 mm.)	
Cr	1.07.922	
	(900 mm.)	
Cr	1.34.520	

	(842 mm.)	
Cr	1.07.935	

Barra deslizante LOFT
 Ø 14 mm, long. 800 mm.



	(800 mm.)	
Cr	034.637.01	

Barra deslizante MINIMAL
 Ø 19 mm, long. 550 mm,
 Ø 19 mm, long. 850 mm.

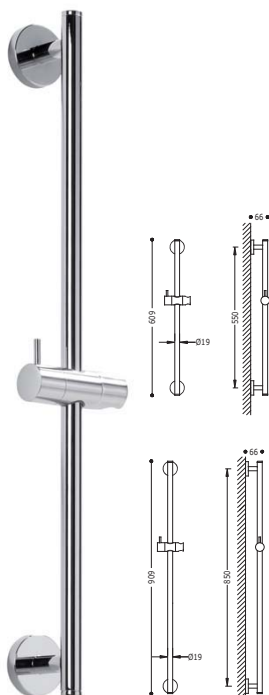

	(550 mm.)	
Cr	1.34.618	
	(850 mm.)	
Cr	1.34.619	

Barra deslizante MAX-MINI
 Ø 20,6 mm, long. 624 mm.



	(624 mm.)	
Cr	034.637.02	

Barra deslizante

Ø 20,6 mm. long. 762 mm.

Barra deslizante PRACTIC-MAX

Ø 20,6 mm. long. 516 mm. con 2 soportes de fijación ajustable.
 Ø 20,6 mm. long. 816 mm. con 2 soportes de fijación ajustable.

Barra deslizante LUXUS

Ø 25 mm. long. 578 mm.



(762 mm.)
 Cr | 034.637.08 |

(516 mm.)
 Cr | 1.61.835 |

(816 mm.)
 Cr | 1.61.838 |

(578 mm.)
 Cr | 1.34.835 |

Ref:

Barra deslizante ECO
Ø 25 mm. long. 614 mm.

Barra deslizante FASHION
Ø 20,6 mm. long. 673 mm.



(614 mm.)

Cr | 1.43.835

(673 mm.)

Cr | 034.637.06

KITS DE DUCHA

Ref.:

Kit anticalcárea PROJECT-SLIM

Latón long. 659 mm. Flexo SATIN
Latón long. 909 mm. Flexo SATIN

Kit anticalcárea PROJECT

Latón long. 659 mm. Flexo SATIN
Latón long. 909 mm. Flexo SATIN

Kit anticalcárea CUADRO-SLIM

Latón long. 663 mm. Flexo SATIN
Latón long. 900 mm. Flexo SATIN

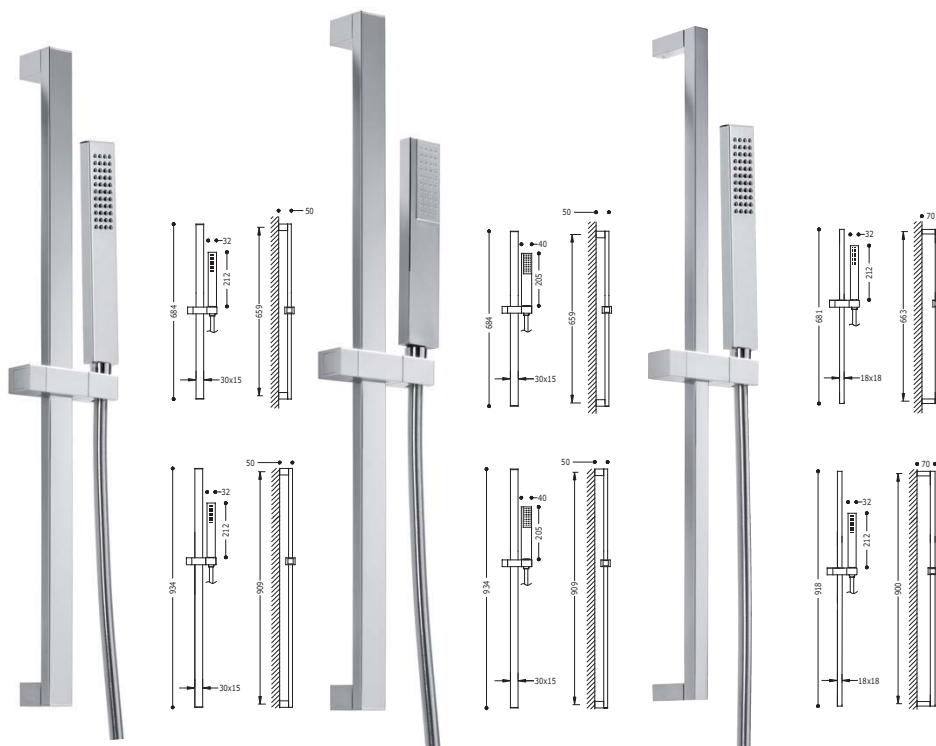

l/m: φ	9,5	(659 mm.)
	Cr	034.526.02
l/m: φ		(909 mm.)
	Cr	034.527.02

l/m: φ	16	(659 mm.)
	Cr	1.34.526
l/m: φ		(909 mm.)
	Cr	1.34.527

l/m: φ	9,5	(663 mm.)
	Cr	034.336.03
l/m: φ		(900 mm.)
	Cr	034.336.04

Kit anticálrea CUADRO
 Latón long. 842 mm. Flexo SATIN

Kit anticálrea CUADRO-MINI
 Latón long. 663 mm. Flexo SATIN
 Latón long. 900 mm. Flexo SATIN

Kit anticálrea LOFT
 Ø 14 mm. long. 800 mm. Flexo SATIN



l/m:	9,5	(842 mm.)
Cr	1.07.934	
	6.07.934	
	4.07.934	

l/m:	15	(663 mm.)
Cr	1.34.512	
		(900 mm.)
Cr	1.34.522	

l/m:	13	(800 mm.)
Cr	034.336.01	

Kit anticalcárea FASHION
 Ø 20,6 mm. long. 673 mm. Flexo SATIN

Kit de ducha
 Ø 19 mm. long. 850 mm. Flexo SATIN

Kit de ducha
 Ø 19 mm. long. 850 mm. Flexo SATIN



l/mc. 10 (673 mm.)
 Cr 034.637.07



l/mc. 9,5 (850 mm.)
 Cr 034.629.02

l/mc. 10 (850 mm.)
 Cr 061.928.01



Kit de ducha MINIMAL

Ø 19 mm. Long. 550 mm. Flexo SATIN.
 Ø 19 mm. Long. 850 mm. Flexo SATIN.

Kit anticálcarea AQUA PLUS

Ø 20,6 mm. long. 516 mm. Flexo SATIN

Kit masaje PLUS

Ø 25 mm. long. 578 mm. Flexo SATIN

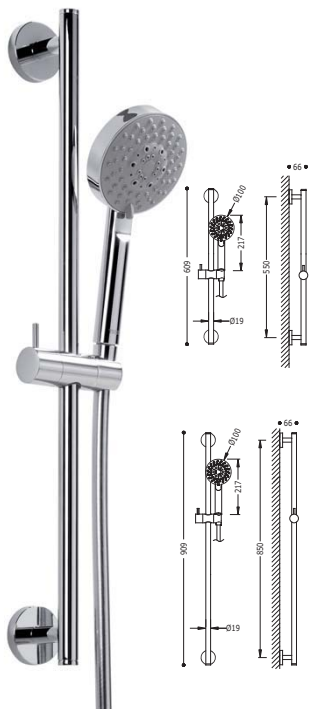

l/m:							◀100▶
	16	16.5	15.5	16	11		
	(550 mm.)						
Cr	1.34.628						
	(850 mm.)						
Cr	1.34.629						

l/m:		◀100▶
	10	
	(516 mm.)	
Cr	061.849.02	

l/m:					◀82▶
	11	8	6		
	(578 mm.)				
Cr	1.34.923				

Kit masaje ECO

Ø 25 mm, long. 614 mm. Flexo SATIN

Kit de ducha

Ø 20,6 mm, long. 575 mm. Flexo SATIN. Con toma pared
 Ø 20,6 mm, long. 966 mm. Flexo SATIN. Con toma pared

Kit de ducha

Ø 20,6 mm, long. 575 mm. Flexo SATIN. Con toma pared
 Ø 20,6 mm, long. 966 mm. Flexo SATIN. Con toma pared



U/m: ρ	15	7	80
	(614 mm.)		
Cr	1.43.836		

U/m: ρ	10	110
	(575 mm.)	
Cr	061.931.03	
	(966 mm.)	
Cr	061.931.05	

U/m: ρ	9.5	95
	(575 mm.)	
Cr	061.931.02	
	(966 mm.)	
Cr	061.931.04	

KITS DE DUCHA DE GRAN FORMATO

Ref:

Conjunto ducha anticálcarea CUADRO

Ducha fija 250x250 mm. Flexo SATIN. Ducha móvil anticálcarea. Adaptable a grupo de ducha y baño-ducha

Kit ducha anticálcarea CUADRO

Ducha fija 250x250 mm. Ducha móvil anticálcarea y flexo SATIN. Con toma pared

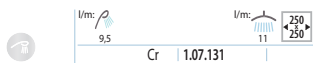
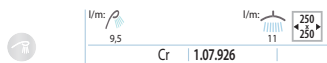
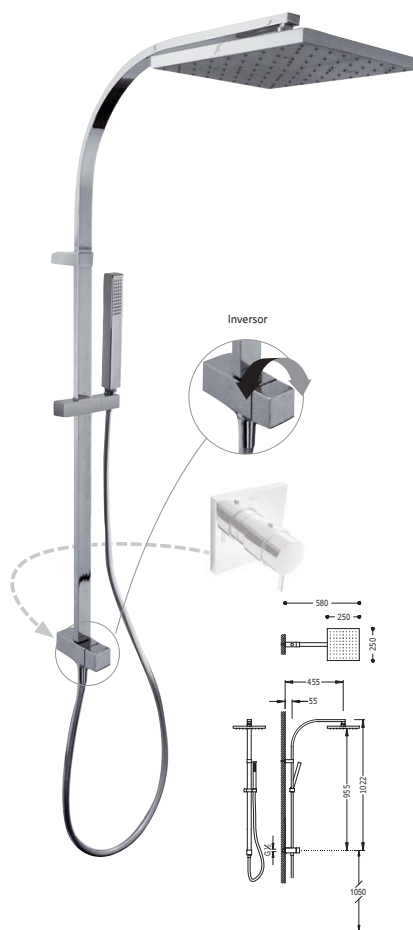
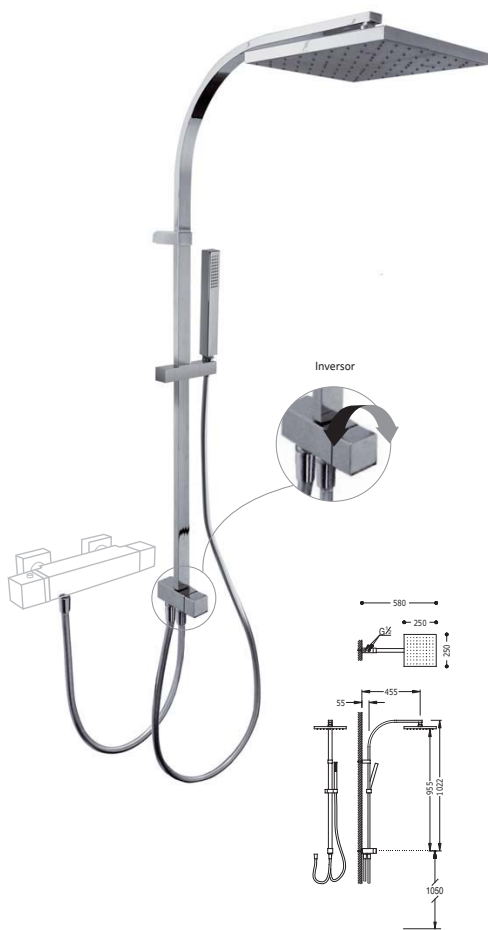

Ref.:

Conjunto ducha anticalcárea CUADRO

Ducha fija 250x250 mm. Flexo SATIN. Ducha móvil anticalcárea. Adaptable a grupo de ducha y baño-ducha

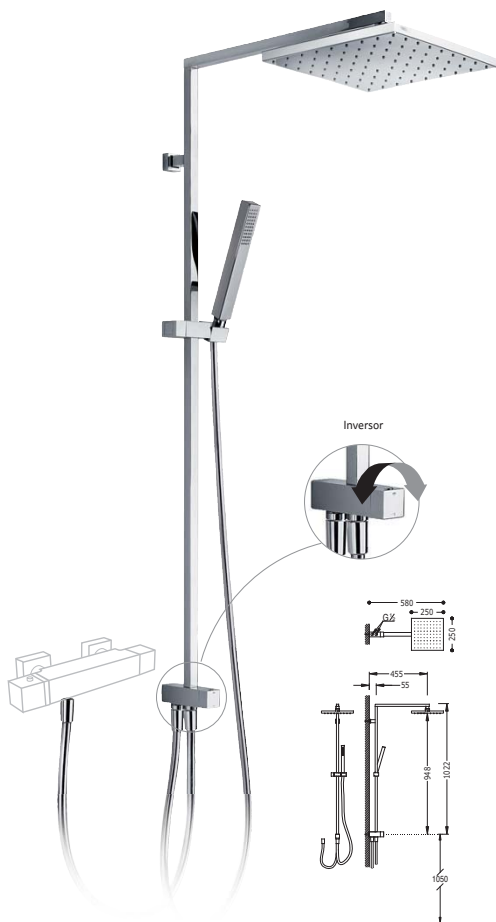

U/m: 9.5 Cr 1.07.476 U/m: 11 250 250

Barra de ducha ECO-TERM

Ducha fija Ø 225 mm. Flexo SATIN. Ducha móvil masaje Ø 100 mm. (5 funciones). Adaptable a grupo de ducha y baño-ducha.

Barra de ducha ECO-TERM

Ducha fija Ø 225 mm. Flexo SATIN. Ducha móvil masaje Ø 100 mm. (5 funciones). Con toma pared

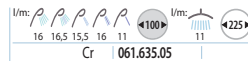

Barra de ducha masaje

Ducha fija Ø 250 mm. Flexo SATIN. Ducha móvil masaje Ø 100 mm. (5 funciones). Adaptable a grupo de ducha y baño-ducha.

Barra de ducha masaje

Ducha fija Ø 250 mm. Flexo SATIN. Ducha móvil masaje Ø 100 mm (5 funciones). Con toma pared

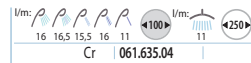

Kit de ducha anticálcara

Barra deslizable sobre sus soportes de pared. Ducha fija Ø 250 mm. Ducha móvil masaje Ø 100 mm (5 posiciones). Flexo SATIN. Adaptable a grupo de ducha y baño-ducha.

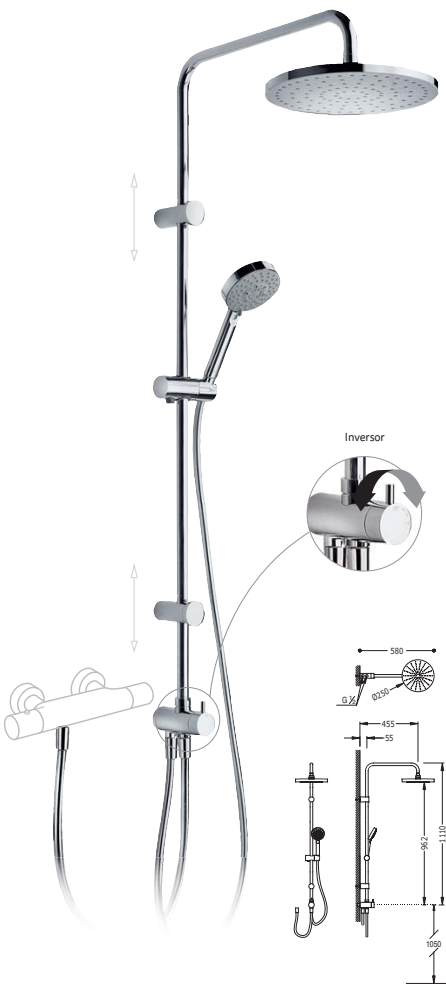

Kit de ducha anticálcara

Barra deslizable sobre sus soportes de pared. Ducha fija 250x250 mm. Ducha anticálcara. Flexo SATIN. Adaptable a grupo de ducha y baño-ducha.

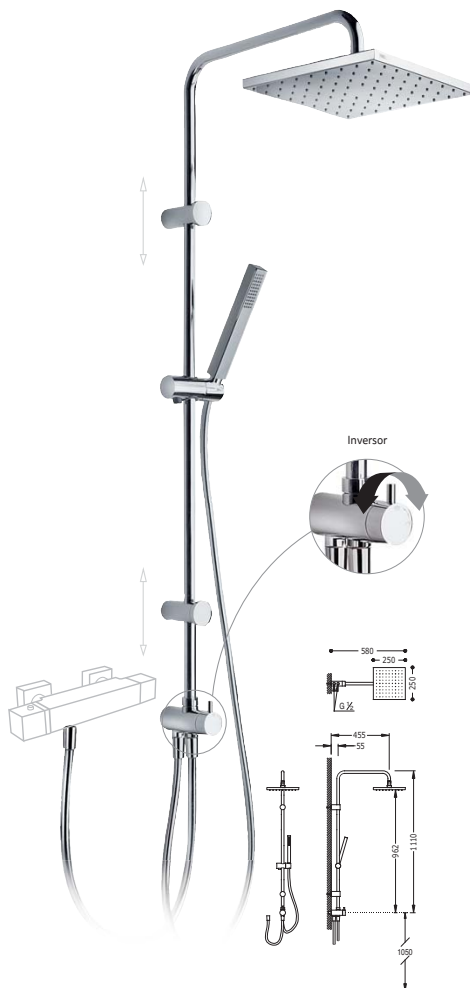

Kit de ducha anticalcárea

Barra deslizable sobre sus soportes de pared. Ducha fija Ø 300 mm. Latón. Ducha móvil masaje Ø 100 mm (5 posiciones). Flexo SATIN. Adaptable a grupo de ducha y baño-ducha.

Kit de ducha anticalcárea

Barra deslizable sobre sus soportes de pared. Ducha fija 300x300 mm. Latón. Ducha anticalcárea. Flexo SATIN. Adaptable a grupo de ducha y baño-ducha.

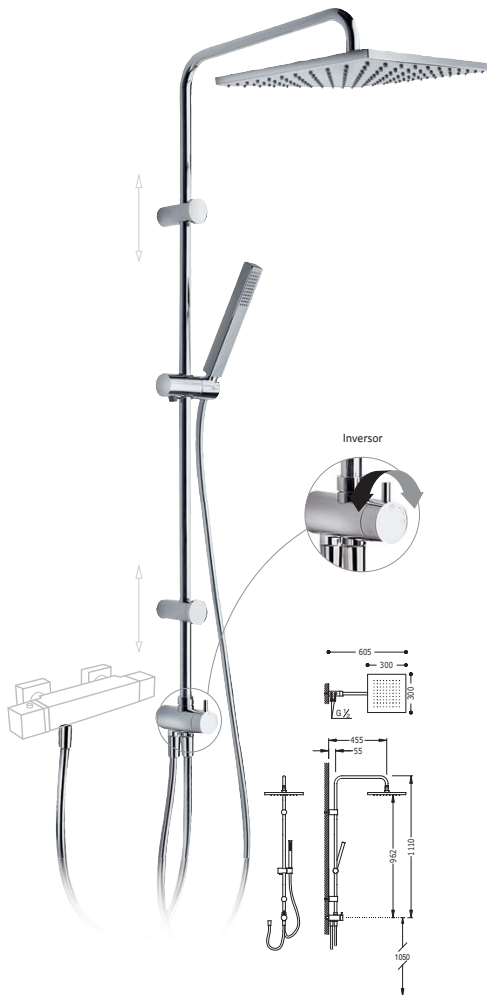
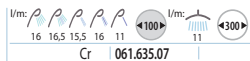
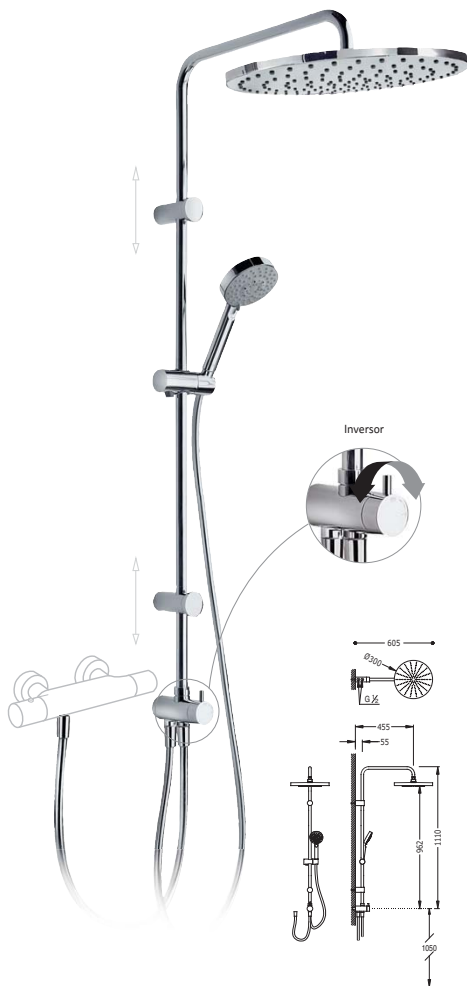

Ref.:

Conjunto de ducha anticálcarea

Ducha fija 200x200 mm. Ducha móvil anticálcarea. Flexo doble engatillado. Adaptable a grupo de ducha y baño-ducha

Instalación

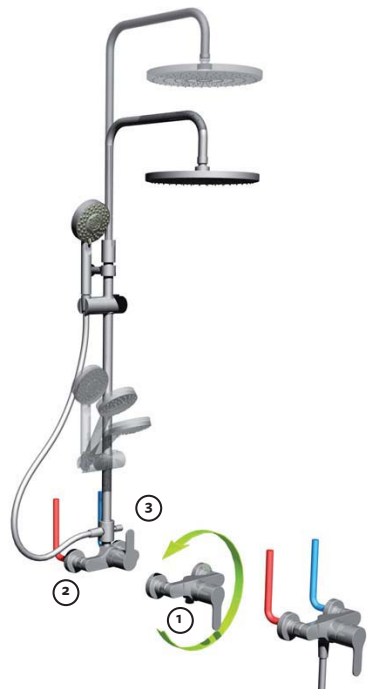

Kit de ducha anticalcárea

Ducha fija Ø 250 mm. Flexo SATIN. Ducha móvil masaje Ø 100 mm (5 funciones). Telescópico. Con distribuidor

Kit de ducha anticalcárea

Ducha fija Ø 225 mm. Flexo SATIN. Ducha móvil anticalcárea Ø 100 mm. Telescópico. Con distribuidor



16 16,5 15,5 16 11

 Cr | 1.61.213

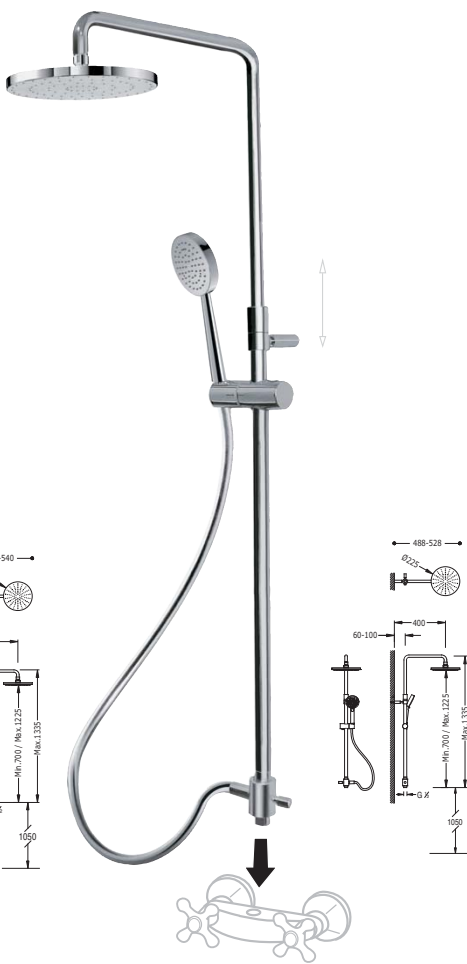

10

 Cr | 061.635.09



DUCHAS

Ref:

Ducha anticalcárea CLASS

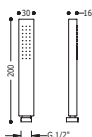

l/m: 12
Cr 299.631.08

Ducha PROJECT

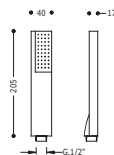

l/m: 16
Cr 1.34.611

Ducha anticalcárea LOFT

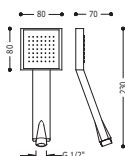

l/m: 15
Cr 1.34.612

Ducha TUB
Ø 24 mm. Latón

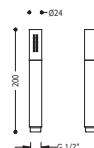

l/m: 12
Cr 91.34.123.80

Ducha tubo WC

Ø 24 mm. Latón. Con record limitador 5 l/m. ANTIGOTEO (para ref.: 34.122, 34.123, 81.122, 81.123, 81.222, 81.223, 62.122, 62.123)

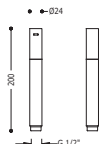

l/m: 5
Cr 91.34.123.90

Ducha con cierre

(para ref.: 81.113, 61.113, 203.113.01)

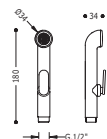

l/m: 8
Cr 299.113.51

Ducha masaje
5 tipos de chorro

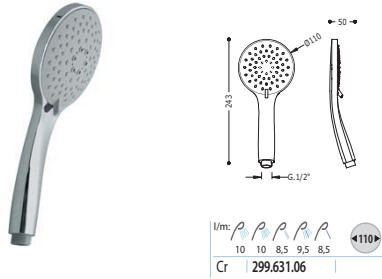

Ducha anticalcárea

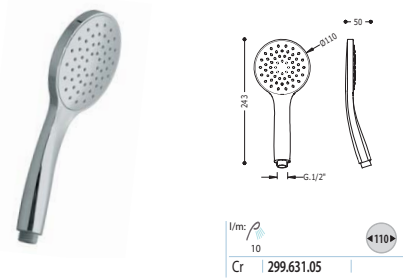

Ducha LEX-100
5 tipos de chorro

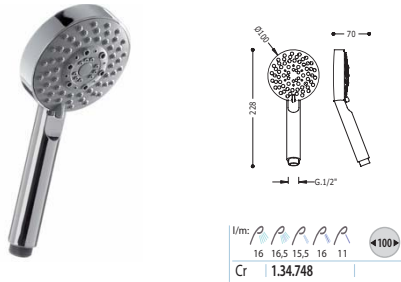

Ducha anticalcárea

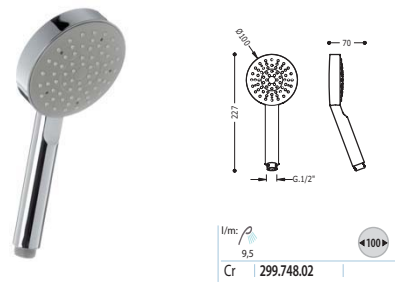

Ducha masaje PAUSA

2 tipos de chorro con reducción de caudal mínimo al pulsar opción STOP-TRES evitando así de nuevo la graduación.



Ducha anticalcárea PAUSA

1 tipo de chorro con reducción de caudal mínimo al pulsar opción STOP-TRES evitando así de nuevo la graduación.



Ducha anticalcárea

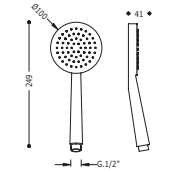

l/m:	10		4100
Cr	299.631.03		
l/m:	6	ECO	4100
Cr	299.631.07		

Ducha ECO-ANTICAL

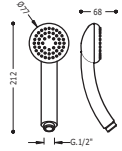

l/m:	7,5		477
Cr	91.34.725		

Ducha masaje AQUA PLUS
2 tipos de chorro

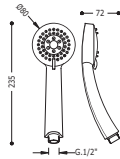

l/m:	15		80
Cr	1.34.627		

Ducha anticalcárea AQUA

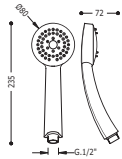

l/m:	15,5		80
Cr	1.34.617		

Ducha masaje PLUS
3 tipos de chorro

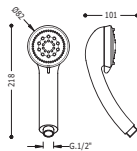

l/m:	11		82
Cr	1.34.823		

Ducha anticalcárea PLUS



l/m:	11		76
Cr	1.34.821		

Ref: |

Ducha ORDAL antigua
Codo antiguo

Ducha monomando peluquería



l/m: ρ
26,5
91.34.825.10 | 4 60 ▶

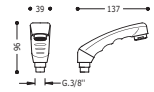

l/m: ρ
11
91.34.450 |

Ducha lavavajillas

(para ref.: 41.443, 50.443, 70.443, 38, 73.443, 02)

Ducha lavavajillas

(para ref.: 30.444, 41.444, 44.444, 72.443, 73.443, 73.444, 039.444.01, 069.444.01)

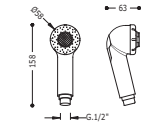

l/m: ρ ρ
12 12
Cr 91.34.880 | 4 58 ▶

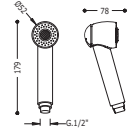

l/m: ρ ρ
12 12
Cr 91.34.849 | 4 52 ▶

BRAZOS DE DUCHA

Brazo ducha ECO masaje PLUS
con regulador de caudal 3 posiciones

Piña brazo ducha PLUS

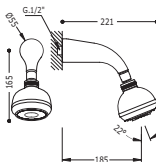

l/m: ρ ρ ρ ρ ρ
17 12 6
Cr 1.34.818 | 4 93 ▶

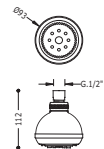

l/m: ρ ρ ρ ρ ρ
17 12 6
Cr 91.34.818.10 | 4 93 ▶



Brazo ducha ECO

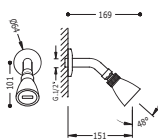

U/m: 37 54
Cr | 1.34.738 |

Piña brazo ducha ECO

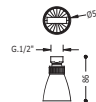

U/m: 37 54
Cr | 91.34.738.10 |

Brazo ducha ORDAL

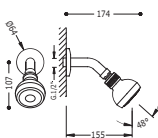

U/m: 22 70
Cr | 1.34.808 |

Piña brazo ducha ORDAL



U/m: 22 70
Cr | 91.34.808.10 |

Codo pared ECO

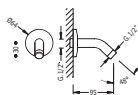

Cr | 1.34.738.50 |

JETS

Ref.:

Jet empotrado de hidromasaje

con 1 tipo de chorro orientable. Incluye un sistema antical, válvula antirretorno y limitador de caudal: 5 l/m. Ø 130 mm.

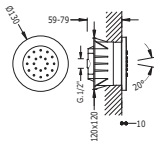

l/m:
Cr | 91.61.515

Jet empotrado de hidromasaje

con 1 tipo de chorro orientable. Incluye un sistema antical, válvula antirretorno y limitador de caudal: 5 l/m. 125x125 mm.

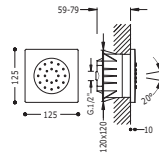

l/m:
Cr | 91.07.515

Ducha lateral de hidromasaje

con 1 tipo de chorro orientable. Incluye un sistema antical, válvula antirretorno y limitador de caudal: 5 l/m. Material Latón.

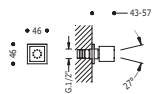

l/m:
Cr | 91.34.515

Ducha lateral de hidromasaje

con 1 tipo de chorro orientable. Incluye un sistema antical, válvula antirretorno y limitador de caudal: 5 l/m. Material Latón.

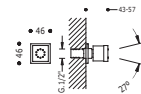

l/m:
Cr | 299.515.01

Ducha lateral de hidromasaje

con 1 tipo de chorro orientable. Incluye un sistema antical, válvula antirretorno y limitador de caudal: 5 l/m. Material Latón.

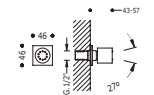

l/m:
Cr | 299.515.03

Ducha lateral de hidromasaje

con 1 tipo de chorro orientable. Incluye un sistema antical, válvula antirretorno y limitador de caudal: 5 l/m. Material Latón.

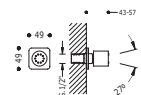

l/m:
Cr | 299.515.02

Ducha lateral de hidromasaje

con 1 tipo de chorro orientable. Incluye un sistema anticaf, válvula antirretorno y limitador de caudal: 5 l/m. Material Latón.

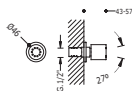

l/m:	5
Cr	91.34.415

Ducha lateral de hidromasaje

con 2 tipos de chorro orientable. 6 l/m. y 4,5 l/m.

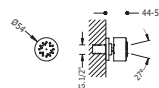

l/m:	6 4,5
Cr	91.34.915

Ducha lateral de hidromasaje

con 1 tipo de chorro orientable 4 l/m.

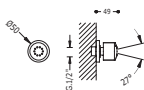

l/m:	4
Cr	91.34.615

FLEXOS

Ref.:

Flexo SATIN

Ø 14,5 mm. Giratorio antitorción

Flexo INOX EXTENSIBLE

long. 1,70 m. y Ø 14 mm.



R1/2"

DUCHA

R1/2"

	(750 mm.)	
St	91.34.609.10	
	(1.200 mm.)	
St	91.34.609.12	
	(1.500 mm.)	
St	91.34.609.15	
	(1.700 mm.)	
St	91.34.609	
	(2.000 mm.)	
St	91.34.609.20	



R1/2"

DUCHA

R1/2"

Inox 91.34.630

Flexo doble engatillado

long. 1,70 m. Tuerca cónica con junta tórica y arandela prisionera en racor. Garantía diez años

Flexo

long. 1,70 m.



R1/2"

DUCHA

R1/2"

EXTENSIBLE

Cr	91.34.828	
Inox	91.34.830.80	



R1/2"

DUCHA

R1/2"

LV	91.34.830.05.1	
CG	91.34.830.05.2	
Ac	91.34.830.05.3	

Flexo doble engatillado

long. 1,25 m. Ø 12 mm. (para ref.: 30.444, 41.443, 41.444, 44.444, 50.443, 52.444, 54.444, 70.443, 72.443, 73.443, 73.444, 39.444, 69.444)

Flexo

long. 1,70 m. Ø 12 mm. (para ref.: 30.430, 30.432, 30.433, 14.444, 43.444, 87.444, 130.460, 62.438, 30.452, 81.438)



M15x1

COCINA

R1/2"

Cr 91.34.867



M15x1

Ø18x2,5

COCINA

Cr 91.34.712

Flexo doble engatillado

long. 1,70 m. para bañera de repisa (para ref.: 06.161, 07.161, 14.150, 17.145, 39.145, 41.145, 43.145, 43.147, 44.145, 61.150, 61.161, 61.181, 62.150, 62.161, 63.145, 63.181, 69.145, 72.145, 73.145, 74.145, 85.145, 87.150, 87.161, 87.181, 89.150, 70.145, 81.150, 81.161, 89.161, 200.161, 200.162, 202.161, 202.661, 203.161, 205.161, 261.150, 262.150)



M15x1 R1/2"

BAÑERA DE REPISA

Cr	91.34.881
----	-----------

Flexo metálico

long. 1,50 m. (para ref.: 145 CLASICTRES, MONOCLASIC 1900, RETROTRES)



M15x1 M15x1

BAÑERA DE REPISA

Cr	91.34.731
LV	91.34.731.05.1

Flexo mod. Peluquería

long. 1,30 m. 3/8" macho 3/8" hembra (para ref.: 72.450)



M3/8"

R3/8"

PELUQUERÍA

■	91.34.887
---	-----------

SOPORTES CON TOMA PARED

Ref.:

Soporte para ducha
con toma pared

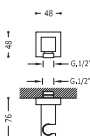

Cr | 006.182.01

Soporte para ducha
con toma pared

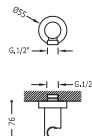

Cr | 205.182.01

Soporte para ducha
con toma pared

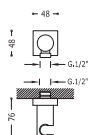

Cr | 061.182.01

Soporte para ducha
con toma pared

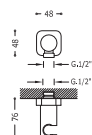

Cr | 200.182.01

Soporte para ducha
con toma pared

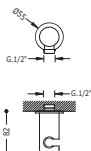

Cr | 024.182.01

SOPORTES ORIENTABLES

Ref.:

Soporte orientable cuadrado
Latón

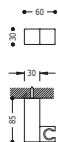

Cr | 1.07.839

Soporte orientable redondo
Latón

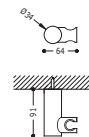

Cr | 1.61.839

Soporte orientable

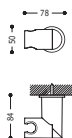

Cr | 299.639.01

Soporte orientable
Latón



Cr | 91.34.832

Soporte fijo

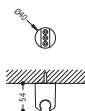

Cr | 91.34.841

Soporte fijo
Con 2 posiciones para todos los flexos

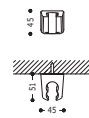

Cr | 91.34.848

CODO ADAPTADOR

Ref:

Codo toma pared para flexo
Toma agua 1/2"



Cr | 1.34.757

Codo toma pared para flexo
Toma agua 1/2"

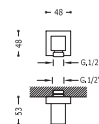

Cr | 006.183.01

Codo toma pared para flexo
Toma agua 1/2"



Cr | 1.34.873

Codo toma pared para flexo
Toma agua 1/2"

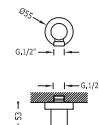

Cr | 205.183.01

Codo toma pared para flexo
Toma agua 1/2"

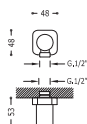

Cr | 200.183.01

Codo toma pared para flexo
Toma agua 1/2"

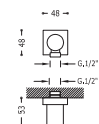

Cr | 061.183.01

OTROS

Ref.:

Jabonera LEX

para barra deslizante Ø 20,5 mm. (para ref.: 1.81.821, 1.81.921)



Cr-Meta | 91.81.921.05

Jabonera

para barra deslizante Ø 18 mm. y Ø 24 mm. y para columnas AVAN-TRES



Cr	1.34.637
Meta	5.34.637.05

Jabonera CUB

para barra deslizante Ø 18 mm. y Ø 24 mm.



Cr | 91.87.195.10

Jabonera DOBLE

para barra deslizante Ø 18 mm. y Ø 24 mm.



Cr | 91.61.195.10

Jabonera LUXUS

para barra deslizante Ø 25 mm.



Cr-Meta | 91.34.735

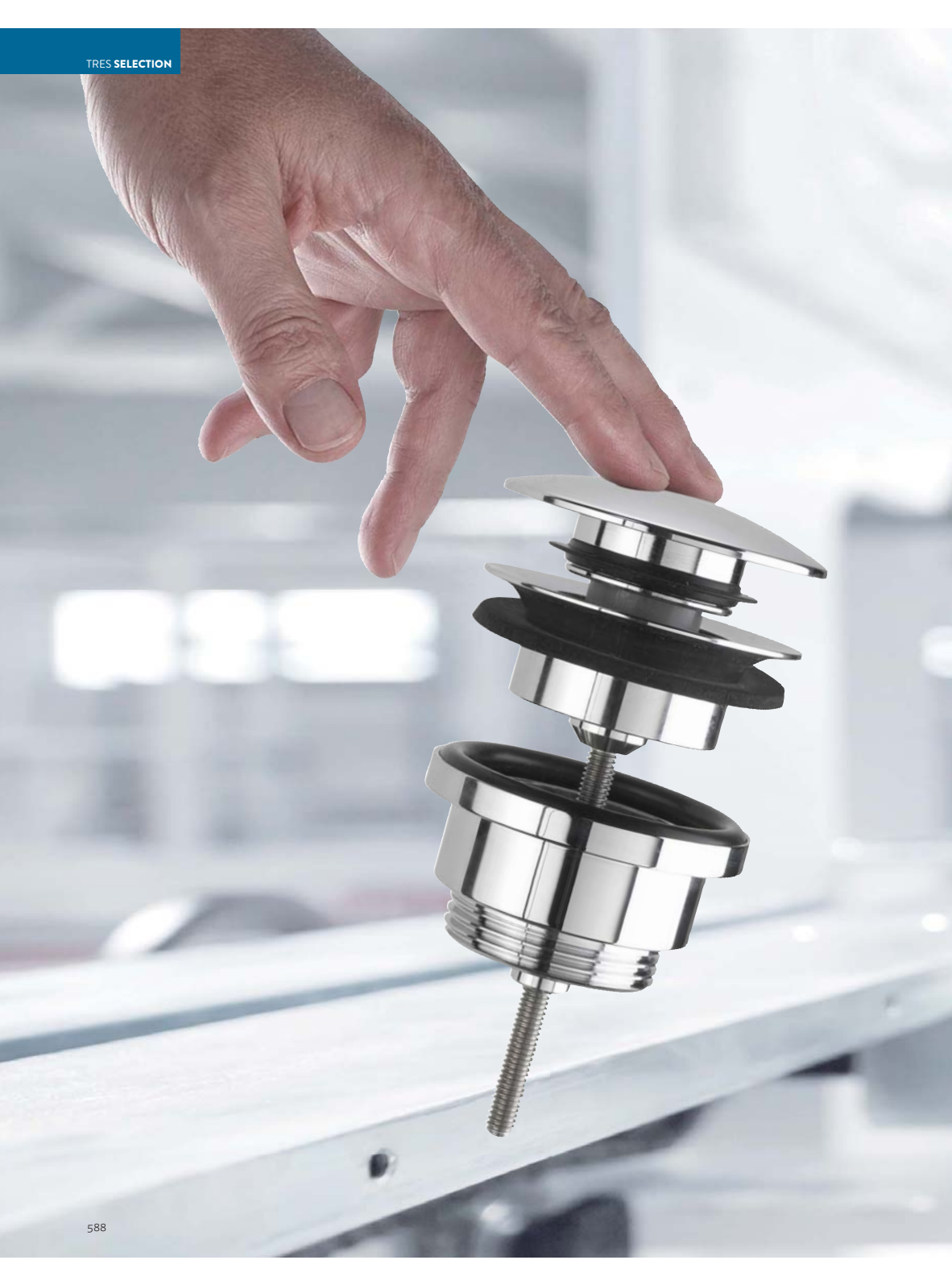

TRES SELECTION

COMPLEMENTOS

- 590 Válvulas
- 596 Desagües
- 598 Sifones
- 601 Florones
- 602 Caños
- 604 Llaves de paso
- 605 Otros
- 606 Excéntricas
- 609 Limitadores de caudal
- 610 Aireadores

RECAMBIOS DE LOS ARTÍCULOS EN:
www.tresgriferia.com



VÁLVULA SIMPLE-RAPID

Blocaje superior

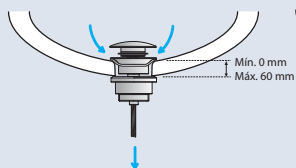
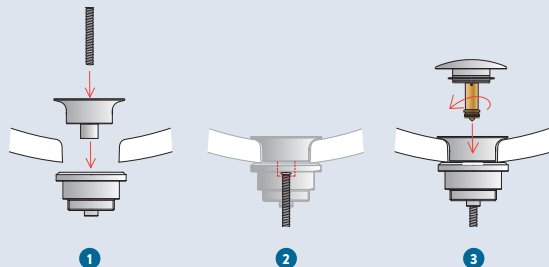

Lavamanos sin rebosadero

REF. 1.61.840
REF. 5.61.840.01
REF. 5.61.840.03

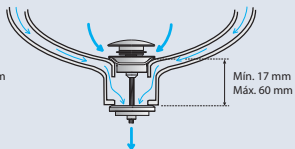

Lavamanos con rebosadero

REF. 1.62.840

VÁLVULA LAVABO

Blocaje inferior

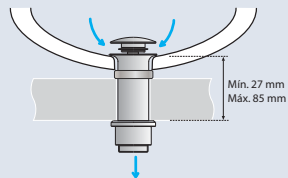

Encimera de madera,...

REF. 1.34.940.10
REF. 1.34.941.10
REF. 1.34.942.10

VÁLVULA SIMPLE-RAPID

Ref:

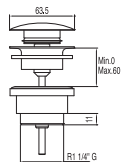

Válvula SIMPLE-RAPID
Tapón Ø 63,5 mm CLICK-CLACK

Cr	1.61.840	
Lv	5.61.840.01	
Ac	5.61.840.03	

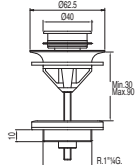

Válvula SIMPLE-RAPID
CLICK-CLACK

Cr	1.62.840	
----	----------	--

Ref:

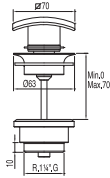

Válvula SIMPLE-RAPID para serie CUADRO-TRES
Tapón cuadrado 70x70 mm CLICK-CLACK

Cr | 1.07.940

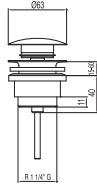

Válvula lavabo SIMPLE-RAPID
Tapón Ø 63 mm CLICK-CLACK

Cr | 1.34.540.10

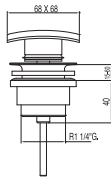

Válvula lavabo SIMPLE-RAPID
Tapón cuadrado 68x68 mm CLICK-CLACK

Cr | 1.34.340.10

VÁLVULA LAVABO SIN REBOSADERO

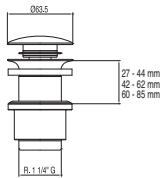

Válvula ciega para lavabo de madera
Tapón Ø 63,5 mm CLICK-CLACK

(27 - 44 mm.)
Cr | 1.34.940.10

(42 - 62 mm.)
Cr | 1.34.941.10

(60 - 85 mm.)
Cr | 1.34.942.10

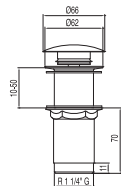

Válvula lavabo sin rebosadero
Tapón Ø 66 mm CLICK-CLACK

Cr | 1.34.540.60



Ref: |

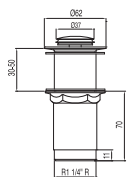

Válvula lavabo sin rebosadero
Tapón Ø 37 mm CLICK-CLACK

Cr | 1.34.540.50 |

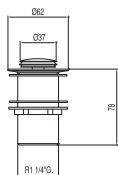

Válvula lavabo sin rebosadero
Tapón Ø 37 mm CLICK-CLACK

Cr | 1.34.540.70 |

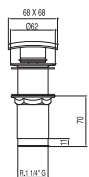

Válvula lavabo sin rebosadero
Tapón cuadrado 68x68 mm CLICK-CLACK

Cr | 1.34.341.20 |

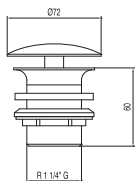

Válvula lavabo libre (desagüe siempre abierto)
Tapón Ø 72 mm

Cr | 1.34.240.10 |

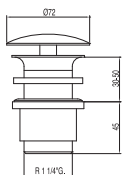

Válvula lavabo libre (desagüe siempre abierto)
Tapón Ø 72 mm

Cr | 1.34.240.30 |

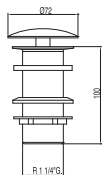

Válvula lavabo libre (desagüe siempre abierto)
Tapón Ø 72 mm

Cr | 1.34.240.30 |

Ref.:

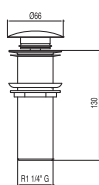

Válvula lavabo sin rebosadero
Tapón Ø 66 mm CLICK-CLACK

Cr | 1.34.540.30

VÁLVULA LAVABO CON REBOSADERO

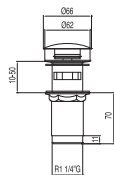

Válvula lavabo con rebosadero
Tapón Ø 66 mm CLICK-CLACK

Cr | 1.34.541.60

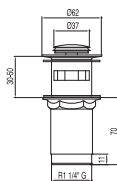

Válvula lavabo con rebosadero
Tapón Ø 37 mm CLICK-CLACK

Cr | 1.34.541.10

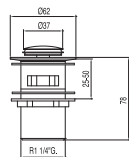

Válvula lavabo con rebosadero
Tapón Ø 37 mm CLICK-CLACK

Cr | 1.34.541.90

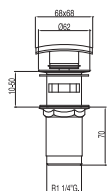

Válvula lavabo con rebosadero
Tapón cuadrado 68x68 mm CLICK-CLACK

Cr | 1.34.340.20



Ref: |

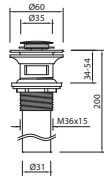

Válvula lavabo con rebosadero
Tapón Ø 35 mm CLICK-CLACK

Cr | 034.540.02 |

VÁLVULA LAVABO

Válvula desagüe automático

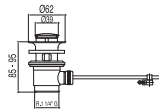

Cr | 1.34.743.10 |

Válvula lavabo con rebosadero
Tapón de latón con cadena



Cr | 1.34.743.20 |

Válvula lavabo sin rebosadero
Tapón de latón con cadena



Cr | 1.34.743.30 |

Válvula desagüe lavabo sin rebosadero
Tapón de latón con cadena

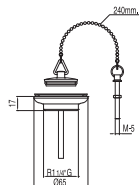

Cr | 1.34.639.10 |

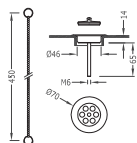

Conjunto de accesorios para lavabo, bidé y fregadero Ø 70
Tapón de latón con cadena 42 cm

LV | 91.34.746.0.5.1

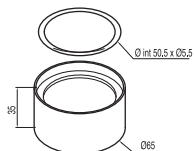

Altura para válvulas de lavabo
Ø 65 x 35 mm.

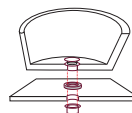

Cr | 91.61.103.48

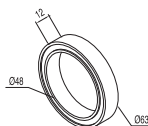

Altura para válvulas de lavabo
Ø 63 x 12 mm.

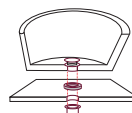

Cr | 1.34.633.10

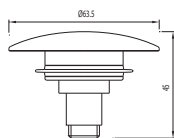

Tapón CLICK-CLACK
Ø 63,5 mm (para ref. 1.61.840)

Cr | 91.61.840.60

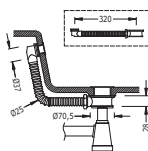

Casquillo para desagües vistos con rebosadero



Cr | 1.34.634.50



DESAGÜES

Ref:

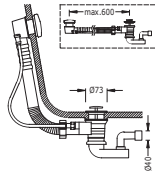

Desagüe automático bañera con rebosadero
Tapón Ø 73 mm

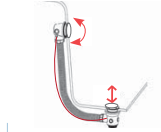

Cr	1.34.846
LV	5.34.846.01

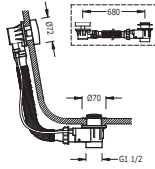

Desagüe automático bañera con rebosadero
Tapón Ø 43 mm

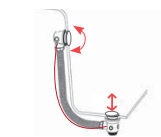

Cr	1.34.534.10
----	-------------

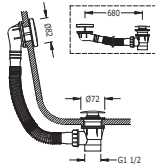

Desagüe bañera con rebosadero
Tapón Ø 72 mm CLICK-CLACK

Cr	1.34.534.20
----	-------------

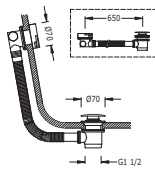

Desagüe bañera y válvula de llenado redonda CASCADA con rebosadero
Tapón Ø 70 mm CLICK-CLACK



Cr	1.34.534.30
----	-------------

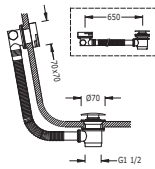

Desagüe bañera y válvula de llenado cuadrada CASCADA con rebosadero
Tapón Ø 70 mm CLICK-CLACK

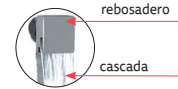

Cr	1.34.534.40
----	-------------

Ref.:

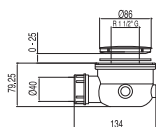

Desagüe sifónico inspeccionable para plato de ducha
con sifón incorporado, desagüe 15 l/min, Ø 86 mm.

Cr | 1.34.552

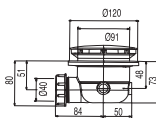

Desagüe sifónico inspeccionable para plato de ducha
con sifón incorporado, desagüe 31 l/min, Ø 120 mm.

Cr | 1.04.840

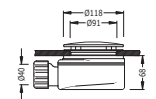

Desagüe sifónico inspeccionable para plato de ducha
con sifón incorporado, desagüe 62 l/min, Ø 118 mm.

Cr | 1.04.841

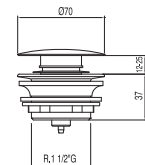

Válvula bañera
Tapón Ø 70 mm CLICK-CLACK

Cr | 1.34.740.10

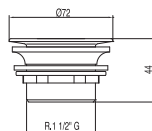

Desagüe para lavadero o similar
Ø 72 mm

Cr | 1.34.740.20

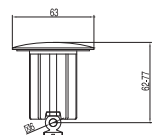

Tapón con suplemento embellecedor para desagüe
automático
Ø 63 mm desagüe automático estándar

Cr | 91.34.840.26



Ref:

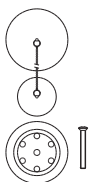

Conjunto de accesorios para bañera Ø70
Cadena de 42 cm.

LV 91.34.745.0.5.1

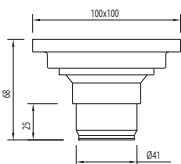

Sumidero
Latón

Cr 034.740.07

SIFONES

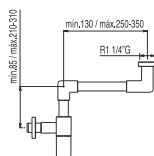

Sifón lavabo visto acodado telescópico

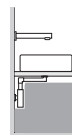

Cr 1.61.103.62

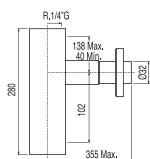

Sifón lavabo visto cuadrado telescópico con faldón

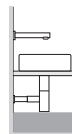

Cr 1.07.103.42

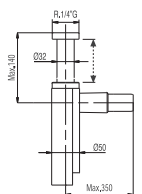

Sifón lavabo visto telescópico con faldón

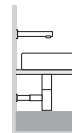

Cr 1.61.103.42
LV 5.61.103.4.5.1

Ref.:

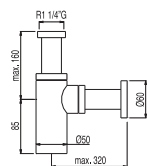

Sifón lavabo visto telescópico

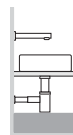

Cr | 1.61.103.72

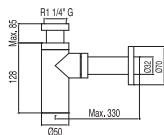

Sifón lavabo visto telescópico

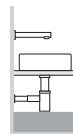

Cr | 1.34.634.10

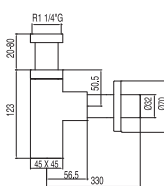

Sifón lavabo visto cuadrado telescópico

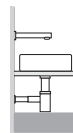

Cr | 1.34.634.20

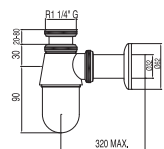

Sifón botella lavabo auto-inspeccionable

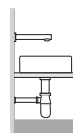

Cr | 1.34.634.30

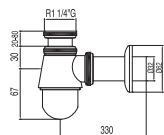

Sifón botella bidé auto-inspeccionable

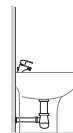

Cr | 1.34.634.40

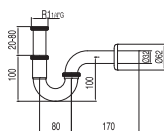

Sifón curvo articulado para lavabo

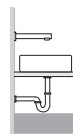

Cr | 1.34.638.10



Ref:

Sifón curvo articulado para lavabo. Con registro.

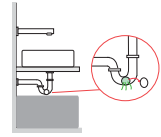
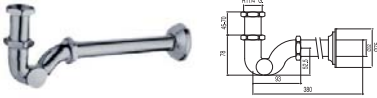

Cr | 1.34.638.20

Tubo coarrugado desagüe flexible
Latón long. 500 mm.

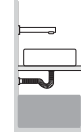
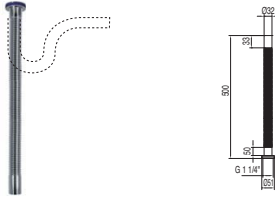

Cr | 91.34.632.50

Sifón PVC bañera



Bl | 1.34.634.60

Alargadera para sifón botella

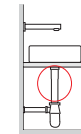
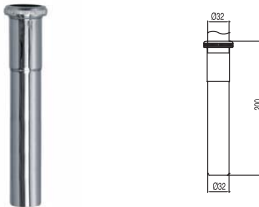

Cr | 91.34.633.20

Tubo coarrugado flexible de latón para sifón botella
300 mm

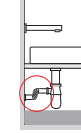

Cr | 91.34.633.30

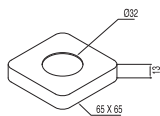

Florón metálico cuadrado
 exterior 65x65, interior Ø 32, altura 13 mm

Cr 91.34.744.10

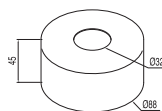

Florón metálico redondo
 exterior Ø 88, interior Ø 32, altura 45 mm

Cr 91.34.744.30



Florón metálico redondo
 exterior Ø 80, interior Ø 32, altura 14 mm

Cr 91.34.744.20



CAÑOS

Ref:

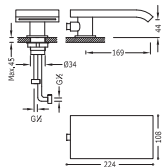

Caño cascada

Cr | 1.62.161.50

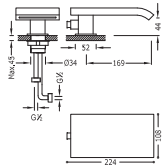

Caño cascada

Cr | 1.87.182.50

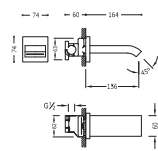

Caño cascada

Cr | 1.07.181

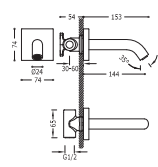

Caño pared

Cr | 210.181.07

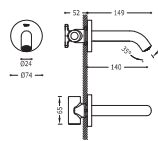

Caño pared

Cr | 262.180.04

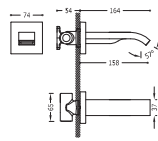

Caño cascada

Cr | 207.181.07

Ref.:

Caño pared



(160 mm.)

Cr 1.61.170.02

(210 mm.)

Cr 061.172.02

(250 mm.)

Cr 1.61.171.02

Caño fundido giratorio de 20,4 cm. (pared)



Cr 1.34.301

Caño tubo giratorio



(240 mm.)

Cr 1.34.302

(290 mm.)

Cr 1.34.303



LLAVES DE PASO

Ref:

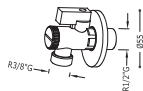

Llave de regulación con filtro
R.1/2" - R.3/8"

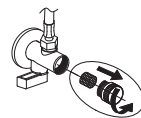

Cr 91.34.525

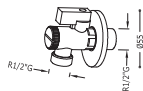

Llave de regulación con filtro
R.1/2" - R.1/2"

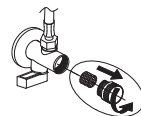

Cr 299.525.05

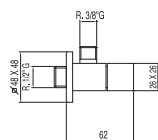

Llave de regulación cuadrada

Cr 1.34.742.20

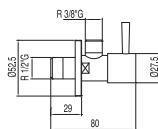

Llave de regulación

Cr 1.34.742.10

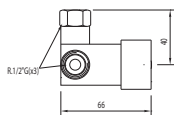

Mezclador dos aguas CON TUBOS FLEXIBLES
para lavabos TRESTRONIC, TOUCH-TRES y TEMPO-TRES

Cr 1.92.507.30

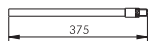

Conexión tubo rígido

M.10x100 (370 mm.)
Cr 91.34.800.2

M.9x100 (320 mm.)
Cr 91.34.800.1

M.8x100 (350 mm.)
Cr 91.34.800.50

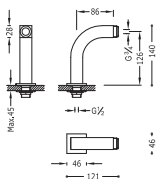

Codo adaptador baño-ducha
2 unidades con silenciador

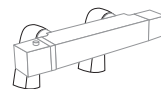

Cr | 299.870.02

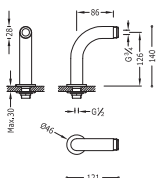

Codo adaptador baño-ducha
2 unidades con silenciador

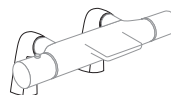

Cr | 299.870.01

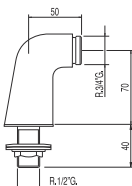

Codo adaptador baño-ducha
2 unidades con silenciador

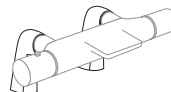

Cr | 1.34.870

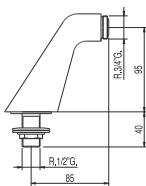

Codo adaptador baño-ducha
2 unidades con silenciador

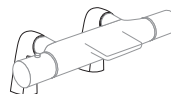

Cr | 1.34.871

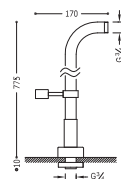

Tomas de agua a suelo de bañera
2 unidades con soporte ducha giratorio

Cr | 1.61.194

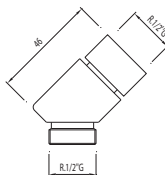

Codo para ducha
para batería bañera de repisa (para ref.: 14.150, 61.150, 62.150, 63.145, 61.161, 87.150, 87.161, 89.150, 89.161)

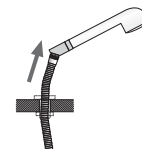

Cr | 91.34.145.80



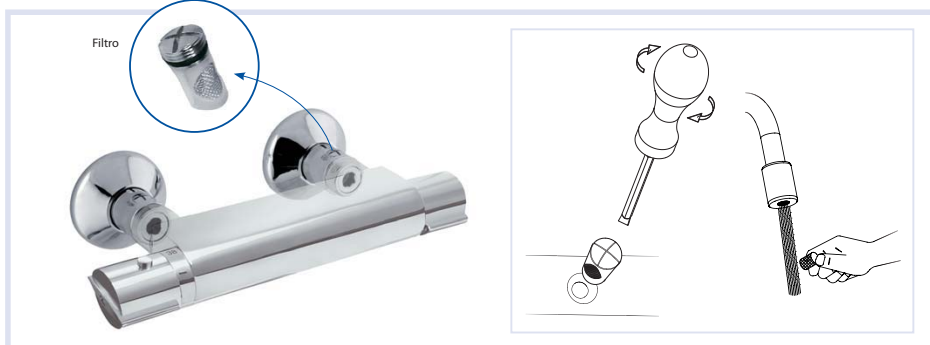
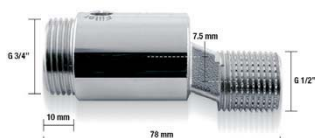

JUEGO DE EXCÉNTRICAS CON FILTRO ESPECIAL PARA TERMOSTÁTICAS

Ref.:



Juego de 2 excéntricas con filtro y florón especial para termostáticas

Cr | 1.94.170.19



Juego de 2 excéntricas con filtro y florón especial para termostáticas + llave de paso

Cr | 1.94.170.29



VÁLVULAS

Ref:

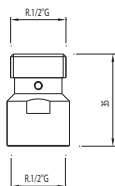

Válvula de vaciado



Cr 91.34.789.06

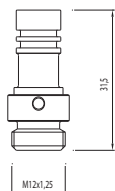

Válvula de vaciado CUADRO
(para ref.: 07.395, 07.926, 07.131)



Cr 91.34.789.07

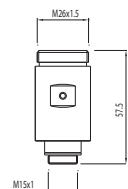

Válvula de vaciado LEX, MAX
Anterior 2012 (para ref.: 81.385, 81.191)



Cr 91.34.789.08

LIMITADOR ANTI-LEGIONELA Y ANTIGOTEO



- Limita el caudal del agua liberando de presión el rociador.
- Evita la procreación de bacterias como la legionela.
- Una vez finalizada la utilización de la ducha, éste evita el goteo del rociador.

Funciona con las duchas: 1.34.126, 91.34.729, 91.34.729.06, 91.34.725, 1.34.821, 1.34.617, 1.34.616, 1.34.924, 91.34.824, 91.34.825.10, 1.34.611.
Funciona con los rociadores*: 1.34.138.25, 1.34.138.26, 1.34.138.30, 1.93.123.10, 1.34.137.25, 1.34.137.26, 1.34.137.30.

* Mejor funcionamiento si se elimina el limitador de los rociadores.

LIMITADOR DE CAUDAL

Ref:

Limitador de caudal
Macho 24/100.

Limitador de caudal
Hembra 22/100.



	(6 l/m.)
Cr 91.34.682.6	
Certificado	(8 l/m.)
Cr 91.34.682	
Certificado	(5 l/m.)
Cr 91.34.682.5	

	(6 l/m.)
Cr 91.34.681.6	
Certificado	(8 l/m.)
Cr 91.34.681	
Certificado	(5 l/m.)
Cr 91.34.681.5	



Limitador de caudal
1/2" - 1/2" Macho-Hembra. 8 l/m.



	(8 l/m.)
Cr 91.34.683.8	
Certificado	(8 l/m.)
Cr 91.34.683	

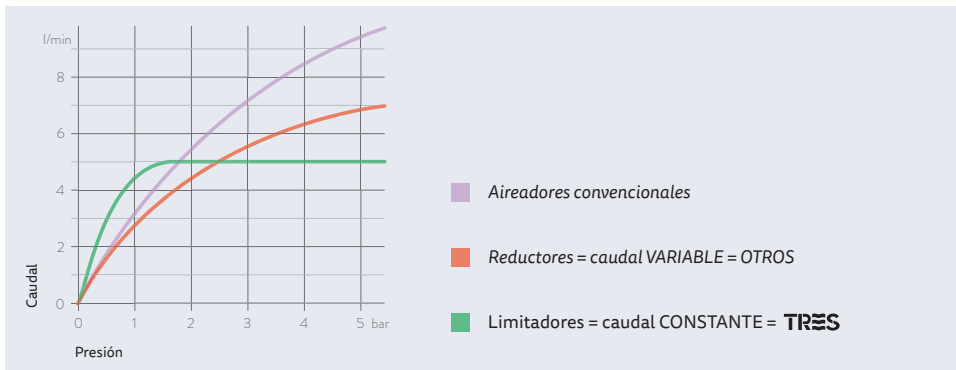

AIREADORES

Ref:

Aireador macho Cascade SLC

24/100 para lavabo, bidé y fregadero y para grupos baño-ducha



Cr	91.34.673	
Ac	91.34.673.5.0.3	
LV	91.34.673.5.0.1	

Aireador hembra Cascade SLC

22/100 para caños de tubo



Cr	91.34.672	
LV	91.34.672.5.0.1	

Aireador macho

24/100 para grupos baño-ducha. Retención "C"



Cr	299.663.10	
----	------------	--

Aireador

Macho 24/100



	299.610.01	
--	------------	--

Aireador

Macho 16/100



	299.610.02	
--	------------	--

Aireador

Macho 16/100



	299.610.05	
--	------------	--



Rompeaguas orientable + llave
Macho 24/100



299.610.06

FILTRO ANTICLORO DUCHAS

Filtro ANTICLORO DUCHAS
Agua filtrada hasta los 10.000 litros.

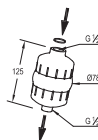

1.30.355.90

AGUA FILTRADA SIN CLORO TAMBIÉN EN LA DUCHA

El cloro es absorbido por la piel cuando nos duchamos, siendo éste un componente tóxico. Nuestro filtro disminuye la cantidad de impurezas, sedimentos, olor y cloro hasta un 99%.

Ideal para personas alérgicas al cloro.

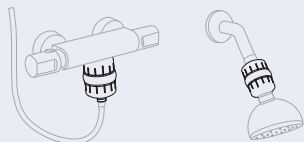

! Agua filtrada hasta los
10.000 litros

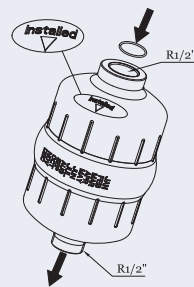

LISTADO DE REFERENCIAS

Ref.	€	Pág.	Ref.	€	Pág.	Ref.	€	Pág.	Ref.	€	Pág.	Ref.	€	Pág.
00			00620003NM	180		00712001D	412		02			03423101		330
001000	551		00620004	411		00712001NED	49		02351501	517		03433601		562
001001	551		00620004AC	48		00715501	417		02351601	517		03433603		561
001010	551		00620004AC	180		00716402	362		02352001C	516		03433101		330
002000	551		00620004BM	48		007164039BM	51		02352001F	516		03443202		328
002010	551		00620004BM	180		00716703BM	49		02416404	142		03443203		328
003000	551		00620004NM	48		00716703NM	49		02416404LV	142		03443205		328
003010	551		00620004NM	180		0071700203BM	50		02416409LV	140		03450101		550
005010	551		00620010	411		0071700203NM	50		02416409LV	140		03450102		550
00610101	404		00620011	411		00717402	366		02417409	140		03452602		561
00610101ACD	44		00620011	531		007174039BM	52		02417409LV	140		03452702		561
00610101BLD	44		00620011AC	48		007174039NM	52		02417609	140		03454002		594
00610101BMD	44		00620011AC	180		00719101	382		02417609LV	140		03462902		563
00610101D	404		00620011BM	48		00719101	413		02417712	139		03463628		379
00610101NED	44		00620011BM	180		00719501	345		02418012	139		03463629		379
00610101NMD	44		00620011NM	48		00719701	382		02418201	584		03463630		379
00610102D	404		00620011NM	180		00731201	351		02419401LV	140		03463701		558
00610503	409		00620012	411		00738501	348		02419401LV	150		03463702		558
00610503AC	47		00620012	531		00738502	354		02419501	141		03463706		560
00610503BM	47		00620012AC	48		00739502AC	52		02419502	141		03463707		563
00610503NM	47		00620012AC	180		00739502AC	344		02419502LV	141		03463708		559
00610504	409		00620012BM	48		00739502BM	52		02419801	141		03463901		334
00610504AC	47		00620012BM	180		00739502BM	344		02420301	134		03463901		342
00610504BM	47		00620012NM	48		00739502NM	52		02420301LV	134		03463901AC		334
00610504NM	47		00620012NM	180		00739502NM	344		02421301	138		03463901AM		334
00611001	405		00620101	405		00749501	342		02421301	148		03463901BLD		334
00611001BLD	45		00620101ACD	45		00750301AC	48		02421301LV	138		03463901FU		334
00611001D	405		00620101BMD	45		00750301AC	48		02421301LV	148		03463901NA		334
00611001NED	45		00620101NED	45		00750301NM	48		02421501	183		03463901NE		334
00611002	405		00620101NMD	45		00810501	410		02422001	136		03463901RO		334
00611002BLD	45		00620501ACD	46		00810501AC	48		02422001LV	136		03463901VI		334
00611002D	405		00620501BMD	46		00810501BM	48		02431001	183		03463901VE		334
00611002NED	45		00620501NMD	46		00810501NM	48		02474601	142		03474007		598
00612001	412		00626001	410		00810502	410		02487101	140		03483102		328
00612001ACD	49		00626010	410		00810503	409		02487101	150		03493101		333
00612001BLD	49		006437BM	176		00810503AC	47		02487101LV	140		03493101AC		333
00612001BMD	49		00648501	406		00810503BM	47		02487101LV	150		03493101BM		333
00612001D	412		00648501ACD	46		00810503NM	47					03493101NM		333
00612001NED	49		00648501BMD	46		00810504	409		03			03493199		332
00612001NMD	49		00648501NMD	46		00810504AC	47		030335AC	178		03493201		333
00612301	413		006486BM	168		00810504BM	47		030335BM	178		03493201AC		333
00612301	546		006486NM	168		00810504NM	47		030335NM	178		03493201BM		333
00612302	413		006487BM	175		00815101	411		030336AC	172		03493201NM		333
00612302	546		006487NM	175		00815201	411		030336BM	172		03493299		332
00612402ACD	49		00660502ACD	46		00815301	411		03033501	527		03944401		525
00612402BMD	49		00660502BMD	46		00815301	531		03044401	525				
00612402NMD	49		00660502NMD	46		00815301AC	48		03045501	527				
00613001	412		00660602ACD	46		00815301AC	181		030496BM	168		06110301		420
00616103	397		00660602BMD	46		00815301BM	48		030497BM	169		06110301D		420
00616103	416		00660602NMD	46		00815301NM	181		030498BM	169		06110302		422
00616103AC	51		00660702ACD	46		00815301NM	48		03216402	150		06110302D		422
00616103BM	51		00660702BMD	46		00815301NM	181		03216402LV	150		06110303		422
00616103NM	51		00660702NMD	46		00815401	411		03216409LV	149		06110303D		422
00616104	397		00661001	404		00815401AC	48		03217409	149		06110501		94
00616104	416		00661001ACD	44		00815401AC	181		03217409LV	149		06110501AC		94
00616105	397		00661001BLD	44		00815401BM	48		03217609	149		06110501AC		94
00616105	416		00661001BMD	44		00815401NM	181		03217609LV	149		06110501BM		94
00616105AC	51		00661001NED	44		00815401NM	48		03219501	151		06110501BM		94
00616105BM	51		00661001NMD	44		00815401NM	181		03219502	150		06110501NM		94
00616105NM	51		00661002	404					03219502LV	150		06110502		94
00616106	397		00663901	333		01			03219801	151		06110502		94
00616106	416		00663901	342		01210002	534		03411601	334		06110502AC		94
00617703	385		00663901AC	333		01210003	535		03411601	342		06110502AC		94
00618003	386		00663901BL	333		01210302	534		03411601AC	334		06110502AC		94
00618003	415		00663901NG	333		01210303	534		03411601AM	334		06110502BM		94
00618003AC	51		00681001	404		01217901	540		03411601BM	334		06110502BM		94
00618003BM	51		00681001ACD	44		01220002	538		03411601LV	334		06110502NM		94
00618003NM	51		00681001BLD	44		01220701	538		03411601NA	334		06110502NM		94
00618006	387		00681001BMD	44		01220801	538		03411601NE	334		06111001		420
00618080	386		00681001NED	44		01299601	550		03411601RO	334		06112001		426
00618080	415		00681001NMD	44		01716702	493		03411601VE	334		06112001ACD		62
00618201	584		00681002	404		01717002	493		03411601VI	334		06112001BMD		62
00618301	586		00698001	387		01717712	493		03412102	328		06112001D		426
00620003	411		00698001	415		01717712	529		03412401	427		06112001NMD		62
00620003AC	530		00698002AC	50		01718012	493		03412401	439		06112001NMD		62
00620003AC	48		00698002BM	50		01718080	494		03412401	456		06112001BLD		62
00620003AC	48		00698002NM	50		01730802D	492		03412401	470		06112001TRUD		62
00620003BM	48		00712001	412		01744001	523		03412401	546		06112001TACD		62
00620003BM	180		00712001ACD	49		01744702	523		03412402	413		06112001TACD		62
00620003NM	48		00712001BLD	49					03412402	546		06112001TACD		62

Ref.	€	Pág.	Ref.	€	Pág.	Ref.	€	Pág.	Ref.	€	Pág.	Ref.	€	Pág.	Ref.	€	Pág.
06112001TVED	62		06216102	431		06917002	485		09286305	273		09288402	282				
06112001TVID	62		06216103	398		06917501	486		09286306	273		09288403	283				
06115501	433		06216103	431		06917712	486		09286307	274		09288404	283				
06115501	443		06216402	363		06918012	486		09286308	274		09288405	284				
06116101	399		06216801	288		06918080	487		09286309	275		09288406	284				
06116101	431		06217402	366		06930802D	484		09286310	275		09288407	285				
06116201	368		06217702	429		06944001	523		09286311	276		09288408	285				
06116201	432		06217703	388		06944401	525		09286312	276		09288499	257				
06116201	449		06217801	288		06944701	523		09286313	277		09288551	41				
06116209	368		06218002	429					09286314	277		09288551	258				
06116209	432		06218003	291					09286315	278		09288552	259				
06116701	427		06218003AC	292		07014502	507		09286316	278		09288553	263				
06117001	427		06218003BM	292		0701770212	505		09286317	279		09288554	73				
06117201	370		06218003NM	292		0701800212	505		09286318	279		09288554	265				
06117201	432		06218005	389		07032003	508		09286319	280		09288555	266				
06117201	449		06218006	293		07044802	508		09286320	280		09288556	270				
06117202	603		06218007	293		07088002	507		09286321	281		09288557	267				
06117209	370		06218008	293		07099002	506		09286322	281		09288558	268				
06117209	432		06218009	389		07099501	550		09286323	281		09288559	260				
06118201	584		06218009	430		07217712	499		09286329	256		09288562	260				
06118301	586		06218010	292		07218012	499		09286401	282		09288563	261				
06120301	421		06218010AC	292					09286402	282		09288564	261				
06120301D	421		06218010BM	292					09286403	283		09288565	261				
06120304	422		06218010NM	292		08113001	456		09286404	283		09288566	268				
06120306	422		06218011	294		08115001	398		09286405	284		09288567	269				
06120601	421		06218012	295		08115001	460		09286406	284		09288568	269				
06120701	421		06218013	295		08116103	398		09286407	285		09288570	263				
06121001	349		06218080	388		08116103	460		09286408	285		09288571	264				
06122001	426		06218080	430		08116104	398		09286409	257		09288573	270				
06122001D	426		06220001	425		08116104	460		09286511	41		09288580	258				
06138501	350		06220002	425		081192	457		09286511	258		09288581	259				
06138502	354		06220002	530		08119301	382		09286512	259		09288582	265				
06139301	348		06220002AC	181		08119301	458		09286513	263		09288583	266				
06144701	424		06220003	425		08119701	383		09286514	73		09288584	262				
06144701	536		06220003	531		08119701	458		09286514	265		09288585	262				
06144801	424		06220003AC	181		08119702	383		09286515	266							
06144801	536		06220070	425		08119702	458		09286516	270							
06151101	433		06220071	425		08120001	455		09286517	267		104840	597				
06151101	443		06220071	531		08120021	455		09286518	268		104841	597				
06163504	569		06220071AC	181		08120021	531		09286519	260		106103	406				
06163505	568		062200AC	181		08126010	455		09286520	260		106103DA	406				
06163506	570		0622008M	181		08149501	342		09286521	261		106124	412				
06163507	571		06220301D	421					09286522	261		10616102	399				
06163508	571		06220301D	421					09286523	267		10616102	416				
06163509	573		06220304	422		09018601	369		09286524	268		106177	414				
06183901AM	337		06220306	422		09018602	364		09286525	269		10617710	414				
06183901BL	337		06220601	421		09026401	369		09286526	269		106180	414				
06183901FUJ	337		06220701	421		09026401	433		09286527	263		10618010	414				
06183901NA	337		06222001	426		09026401	443		09286528	264		106200	410				
06183901NE	337		06222001D	426		09026401	461		09286529	265		1062501	406				
06183901RO	337		06226010	425		09026401	473		09286530	258		106245	400				
06183901VE	337		06231201	352		09026401	548		09286531	259		106245	416				
06183901VI	337		06237801	289		09027401	371		09286532	265		106377	385				
06184902	564		06243201	327		09027401	433		09286533	266		106437	176				
06192801	563		062435AC	171		09027401	443		09286534	262		106440	169				
06193102	565		062435BM	171		09027401	461		09286535	262		106486	168				
06193103	565		06243601AC	172		09027401	474		09288299	256		106486AM	168				
06193104	565		06243601BM	172		09027401	548		09288301	271		106486FUJ	168				
06193105	565		06248701	176		09049501	342		09288302	272		106486NA	168				
06210301	420		06248801	170		09096020	374		09288303	271		106486RO	168				
06210301D	420		06251601	389		09096021	374		09288304	272		106486VE	168				
06210302	422		06251601	430		09096022	375		09288305	273		106486VI	168				
06210302D	422		06254201	173		09096022	463		09288306	273		106487	175				
06210303	422		06254201AC	173		09096022	475		09288307	274		106487AM	175				
06210303D	422		06254201BM	173		09096401	369		09288308	274		106487FUJ	175				
06211001	420		06290501	423		09096401	433		09288309	275		106487NA	175				
06212001	426		06290502	423		09096401	443		09288310	275		106487RO	175				
06212001ACD	62		06290503	423		09096401	461		09288311	276		106487VE	175				
06212001BMD	62		06298001	388		09096401	473		09288312	276		106487VI	175				
06212001D	426		06298001	429		09096401	548		09288313	277		106603	407				
06212001NMD	62		06298002	390		09097401	371		09288314	277		106604	407				
06212001TAMD	62		06316201	432		09097401	433		09288315	278		106605	407				
06212001TBLD	62		06316209	432		09097401	443		09288316	278		106606	407				
06212001TFUD	62		06317201	433		09097401	461		09288317	279		106607	407				
06212001TNAD	62		06317209	433		09097401	474		09288318	279		10691405	355				
06212001TNED	62		06321101	350		09097401	548		09288319	280		106980	386				
06212001TRGD	62		06331301	353		09217101	537		09288320	280		106980	414				
06212001TWD	62		06339301	349		09286299	256		09288321	281		106985	387				
06212001TVID	62		06910302	484		09288601	271		09288322	281		107103	406				
06213001	427		06910302D	484		09286302	271		09288323	281		107103D	598				
06215001AC	67		06913001	485		09286303	272		09288324	281		107103DA	406				
06216102	398		06916702	485		09286304	272		09288401	282		107131	566				

LISTADO DE REFERENCIAS

Ref.	€	Pág.	Ref.	€	Pág.	Ref.	€	Pág.	Ref.	€	Pág.	Ref.	€	Pág.
10716102	399					12910561	134		13424010	592		134738		579
10716102	416					129106	135		13424020	592		13473850		579
107164	368		123100C	512		12912061	136		13424030	592		13474010		597
107164	417		123100F	512		12912461	136		134245	401		13474020		597
1071649	368		123103	512					134301	603		13474110		606
1071649	417		123105	512					134302	603		13474210		604
107167	413		123120	512		130335	178		134303	603		13474220		604
10717002	413		123125C	513		130336	171		134331	329		13474310		594
107174	370		123125F	513		130337	524		13434010	591		13474320		594
107174	417		123155C	516		130338	524		13434020	593		13474330		594
1071749	370		123155F	516		13035590	611		13434120	592		134748		576
1071749	417		123167	513		130432	177		134345	400		134757		586
107181	602		123170	513		130434	525		134345	432		134808		579
107395	344		123210	513		130481	529		134432	330		134818		578
107440	170		123214	514		130484	529		134433	331		134821		577
107476	567		123215	514		130485	528		134445	401		134823		577
107503	410		123217	514		130487	176		134445	416		134835		559
107511	417		123230	514		130493	528		134445	416		134846		596
10763601	157		123306	515		130495	529		134445	431		134870		605
10763603	157		123310	513		130496	168		134445	431		134871		605
10763606	157		123314	514		130497	169		134445	432		134873		586
10763608	157		123315	514		130497AM	169		134445	442		134903		322
10763620	157		123317	514		130497FUJ	169		134445	460		134923		564
10763623	157		123330	514		130497NA	169		134445	460		134940		319
10763627	157		123342	515		130497RO	169		134445	473		13494010		591
107839	585		123360	514		130497VE	169		13445301	527		13494110		591
107922	557		123416	514		130497VI	169		13446302	355		13494210		591
107926	566		123500C	516		130498	168		134512	562		134944		316
107934	562		123500F	516		132100C	146		134516	557		134950		319
107935	557		123505	515		132100F	146		134517	557		134951		316
107940	591		123506	515		132103	146		134520	557		137103		146
107964	348		123510C	512		132104	146		13452102	327		137104		146
108124	412		123510F	512		132120	147		134522	562		137106		146
108496	182		123511C	516		132124	147		13452202	327		137120		147
108496	408		123511F	516		132125C	147		134526	561		137124		147
108497	182		123512C	516		132125F	147		134527	561		139102		492
108497	408		123512F	516		132130	147		134530	576		139102DA		492
108498	182		123513C	516		132145	149		134531	576		139103		492
108604	408		123513F	516		132176	148		13453410	596		139103DA		492
108605	408		123515	517		132335	183		13453420	596		139104		492
108606	408		123520C	516		132342	183		13453430	596		139104DA		492
			123520F	516		132416	183		13453440	596		139120		493
			124125C	135		132510C	146		13454010	591		139120DA		493
			124125F	135		132510F	146		13454030	592		139441		523
112100	535		12414561	139		132768	147		13454050	593				
112103	534		124146	139		132774	147		13454060	591				
112161	539		124151	135		13315510C	517		13454070	592		14244102		174
11216150	539		12415561C	143		13315510F	517		13454110	593		143835		560
112162	540		12415561F	143		133155C	151		13454160	593		143836		565
112163	539		12415761C	143		133155F	151		13454190	593				
112167	539		12415761F	143		13315710C	517		134550	385				
112177	540		12416761	136		13315710F	517		134550	429		16110342		598
112178	540		12417061	136		133157C	151		134552	597		16110362		598
112200	538		124173	138		133157F	151		134611	575		16110372		599
112206	538		124194	140		133516	517		134612	575		16117002		603
112207	539		124194	150		133517	517		134617	577		16117102		603
112360	529		1242807	137		133518	517		134618	558		16118740		326
112360	541		1242907	137		134122	427		134619	558		161194		371
112360	549		124306	135		134122	470		13462101	326		161194		428
112370	529		124334	178		134122	546		13462102	327		161194		605
112370	541		124341	174		134123	427		13462104	326		161213		573
112370	549		12434261	183		134123	470		13462202	327		161214		570
112441	541		124500	143		134123	546		134627	577		161445		179
112441	549		124503	135		13413726	325		134628	564		161446		179
113333	174		124520	143		13413726	342		134629	564		161475		568
114444	177		12463601	162		13413730	325		13463310	595		161476		569
11463601	158		12463603	162		13413730	342		13463410	599		16163601		158
11463602	158		12463604	163		13413826	324		13463420	599		16163602		158
11463603	158		12463605	162		13413826	342		13463430	599		16163606		158
11463609	158		12463606	162		13413830	324		13463440	599		16163615		160
11463610	158		12463607	163		13413830	342		13463450	595		16163616		159
117103	492		12463608	162		13413940	326		13463460	600		16163618		159
117103DA	492		12463609	162		134161	529		13463624	158		16163620		159
117104	492		12463610	163		13416703	540		134637	587		16163623		158
117104DA	492		12463611	162		13416803	540		13463810	599		16163624		158
117145	495		12463612	162		134183	159		13463820	600		161835		559
117175	494		12463613	163		134184	159		13463910	594		161838		559
117333	524		12463615	162		13418440	159		134714	323		161839		585
117377	494		124824	162		13419502	355		134715	322		161840		590
117440	523		124824	395		134221	329		134732	138		162113		470
117980	495		12910361	134		134232	330		134732	148		162113		547
			12910461	134		134233	331		134732	332		162161		399

Ref.	€	Pág.	Ref.	€	Pág.	Ref.	€	Pág.	Ref.	€	Pág.	Ref.	€	Pág.						
162161	431		172418	501		19			20011002VID	78		20017409AM	84							
16216150	602		172420	500					20012001	439		20017409BL	84		20017409BM	84				
162200	425		172440	500					20012001ACD	81		20017409BM	84		20017409FU	84				
162200	530		172443	501					20012001AMD	81		20017409NA	84		20017409NE	84				
162245	400		172447	500					20012001BLD	81		20017409NE	84		20017409RO	84				
162245	431		172450	549					20012001BMD	81		20017409RO	84		20017409VE	84				
16235590	527		17510302	504					20012001D	439		20017409VE	84		20017701	440				
162435	171		17510402	504					20012001FUD	371		20017702	392		20018001	440				
162436	172		17512002	504					20012001NAD	81		20018002	392		20018002	440				
162437	177		17530802	504					20012001NED	81		20018002	440		20018002ZAM	83				
162438	177		1771013	498					20012001NMD	81		20018002ZBL	83		20018002ZBL	83				
162440	174		177104	498					20012001ROD	81		20018002ZFU	83		20018002ZNA	83				
162441	521		177120	498					20012001VED	81		20018002ZNE	83		20018002ZRO	83				
162442	522		18						20012001VID	81		20018002ZVE	83		20018002ZVE	83				
162453	527								181103	452		20012002	439		20018002ZVE	83		20018002ZVE	83	
162456	527								181103	452		20012002ACD	81		20018002ZVE	83		20018002ZVE	83	
162503	424								181113	456		20012002ACD	81		20018002ZVE	83		20018002ZVE	83	
162503	454								181113	547		20012002BLD	81		20018002ZVE	83		20018002ZVE	83	
162503	468								181120	455		20012002BMD	81		20018002ZVE	83		20018002ZVE	83	
162540	173					181164	368		20012002D	439		20018002ZVE	83		20018002ZVE	83				
162541	172					181164	461		20012002FUD	81		20018002ZVE	83		20018002ZVE	83				
162603	424					181164	473		20012002NAD	81		20018002ZVE	83		20018002ZVE	83				
162603	454					1811649	368		20012002NED	81		20018002ZVE	83		20018002ZVE	83				
162603	468					1811649	461		192445	179		20018003	393		20018003	393				
162840	590					1811649	473		19250730	537		20018004	393		20018004	393				
163103	423					181174	370		19250730	604		20018005	392		20018005	392				
163120	426					181174	461		19260603	536		20018005	441		20018005	441				
163145	399					181174	473		19290603	536		20018005AC	83		20018005AC	83				
163145	432					1811749	370		193123	378		20018005BM	83		20018005BM	83				
163151	425					1811749	461		193124	378		20018005NM	83		20018005NM	83				
163151	531					1811749	473		193223	378		20018010	440		20018010	440				
163152	425		18117705	459		19417019	607		20018080	441		20018080	441							
163194	428		18118005	459		19417029	607		20018201	584		20018201	584							
163333	182		181191	383		20			20018203	337		20018201AC	337							
163868	428		181191	457					20018203	442		20018201AM	337		20018201AM	337				
163874	428		18119502	355					20018203AC	83		20018201BL	337		20018201BL	337				
168103	423		181200	455					20018203BM	83		20018201FU	337		20018201FU	337				
168105	423		181200	531					20018203NM	83		20018201NA	337		20018201NA	337				
168120	426		181203	453					200116401	368		20018201NE	337		20018201NE	337				
169103	484		181207	453					200116401	442		20018201RO	337		20018201RO	337				
169103DA	484		181217	453					20010301ACD	77		20018201VE	337		20018201VE	337				
169104	484		181222	456					20010301AMD	77		20018301	586		20018301	586				
169104DA	484		181222	546					20010301BLD	77		20019501	347		20019501AM	85				
169120	485		181223	456					20010301BMD	77		20019501AM	85		20019501BL	347				
169120DA	485		181223	546					20010301D	436		20019501BL	347		20019501FU	85				
169145	487		181224	455					20010301FUD	77		20019501FU	85		20019501NA	85				
169353	524		181303	454					20010301NAD	77		20019501NA	85		20019501NE	85				
169377	486		181333	522					20010301NED	77		20019501NE	85		20019501RO	85				
169440	522		181341	522					20010301NMD	77		20019501RO	85		20019501VE	85				
169980	487		181385	361					20010301ROD	77		20019501VE	85		20019501VE	85				
17			181385	462					20010301VED	77		20019501VE	85		20019501VE	85				
			17010302	504		181385	474		20010301VID	77		20019501VE	85		20019501VE	85				
			1701030211	548		18138506	355		20010302	436		20019501VE	85		20019501VE	85				
			17010402	504		181386	462		20010302ACD	76		20019501VE	85		20019501VE	85				
			17012002	504		181403	454		20010302AMD	76		20019501VE	85		20019501VE	85				
			17016702	505		181436	521		20010302BLD	76		20019501VE	85		20019501VE	85				
			17017002	505		181437	525		20010302BMD	76		20019501VE	85		20019501VE	85				
			17017002	505		181438	525		20010302D	436		20019501VE	85		20019501VE	85				
			17017302	505		181468	457		20010302FUD	76		20019501VE	85		20019501VE	85				
			17021802	508		181474	457		20010302NAD	76		20019501VE	85		20019501VE	85				
			17031802	508		181540	521		20010302NED	76		20019501VE	85		20019501VE	85				
			17032002	508		181703	454		20010302NMD	76		20019501VE	85		20019501VE	85				
			17033202	508		18188005	394		20010302ROD	76		20019501VE	85		20019501VE	85				
			17033302	508		18188005	459		20010302VED	76		20019501VE	85		20019501VE	85				
			17041802	508		181903	452		20010302VID	76		20019501VE	85		20019501VE	85				
			17044002	509		181920	455		20011001	437		20019501VE	85		20019501VE	85				
			17044102	508		183333	522		20011001AMD	78		20019501VE	85		20019501VE	85				
			17044702	507		183341	522		20011001BLD	78		20019501VE	85		20019501VE	85				
17097002	506		183395	363		20011001FUD	78		20019501VE	85		20019501VE	85							
17098002	506		183398	366		20011001INAD	78		20019501VE	85		20019501VE	85							
172103	498		186103	452		20011001NED	78		20019501VE	85		20019501VE	85							
172104	498		186120	455		20011001ROD	78		20019501VE	85		20019501VE	85							
172120	498		186203	453		20011001VED	78		20019501VE	85		20019501VE	85							
172145	499		186207	453		20011001VID	78		20019501VE	85		20019501VE	85							
172218	501		186217	453		20011002	437		20019501VE	85		20019501VE	85							
172317	500		186903	452		20011002AMD	78		20019501VE	85		20019501VE	85							
172318	500		186903	455		20011002BLD	78		20019501VE	85		20019501VE	85							
17231811	548		1871250	602		20011002FUD	78		20019501VE	85		20019501VE	85							
172333	500		187440	170		20011002NAD	78		20019501VE	85		20019501VE	85							
17233311	548		187444	177		20011002NED	78		20019501VE	85		20019501VE	85							
172367	498		189245	401		20011002ROD	78		20019501VE	85		20019501VE	85							
172370	498		189245	460		20011002VED	78		20019501VE	85		20019501VE	85							

LISTADO DE REFERENCIAS

Ref.	€	Pág.	Ref.	€	Pág.	Ref.	€	Pág.	Ref.	€	Pág.	Ref.	€	Pág.
20020304	436		20020504VED	79		20117701	290		20217409NM	36		20312003D	469	
20020304ACD	76		20020504VID	79		20117702	290		20217701	31		20313001	470	
20020304AMD	76		20020505	437		20117703	295		20217702	31		20316101	399	
20020304BLD	76		20020505ACD	79		20117704	291		20217703	31		20316101	473	
20020304BMD	76		20020505AMD	79		20118001	290		20218001	31		20316102	399	
20020304FUD	76		20020505BLD	79		20118002	290		20218002	31		20316102	473	
20020304NAD	76		20020505BMD	79		20118003	294		20218003	33		20316701	471	
20020304NED	76		20020505FUD	79		20118004	294		20218003AC	33		20317001	471	
20020304NMD	76		20020505NAD	79		20118006	290		20218003BM	33		20317701	472	
20020304ROD	76		20020505NED	79		20118007	291		20218003NM	33		20317702	393	
20020304VED	76		20020505NMD	79		20119501	289		20218005	34		20318001	472	
20020304VID	76		20020505ROD	79		20210301	26		20218006	32		20318002	394	
20020305	436		20020505VED	79		20210301ACD	27		20218006AC	32		20318002	472	
20020305ACD	77		20020505VID	79		20210301BLD	27		20218006BL	32		20318003	394	
20020305AMD	77		20020506	437		20210301BMD	27		20218006BM	32		20319101	384	
20020305BLD	77		20020506ACD	79		20210301D	26		20218006NE	32		20319101	471	
20020305BMD	77		20020506AMD	79		20210301INED	27		20218006NM	32		20320001	469	
20020305FUD	77		20020506BLD	79		20210301NMD	27		20218007	35		20320002	467	
20020305NAD	77		20020506BMD	79		20210302	26		20218008	38		20320301	467	
20020305NED	77		20020506FUD	79		20210302D	26		20219101	30		20320301D	467	
20020305NMD	77		20020506NAD	79		20210303	26		20219101AC	31		20320701	467	
20020305ROD	77		20020506NED	79		20210303ACD	27		20219101BM	31		20320701D	467	
20020305VED	77		20020506NMD	79		20210303BLD	27		20219101INM	31		20321001	469	
20020305VID	77		20020506ROD	79		20210303BMD	27		20219501	37		20321701	467	
20020306	436		20020506VED	79		20210303NED	27		20219501	343		20321701D	467	
20020306ACD	76		20020506VID	79		20210303NMD	27		20219501AC	37		20322401	469	
20020306AMD	76		20022401	499		20210304	26		20219501AC	343		20324501	400	
20020306BLD	76		20022401ACD	81		20210305	26		20219501BL	38		20324501	431	
20020306BMD	76		20022401AMD	81		20210305ACD	27		20219501BL	343		20324501	442	
20020306FUD	76		20022401BLD	81		20210305BLD	27		20219501BM	38		20324501	460	
20020306NAD	76		20022401BMD	81		20210305BMD	27		20219501BM	343		20324501	473	
20020306NED	76		20022401FUD	81		20210305NED	27		20219501NE	37		20326010	469	
20020306NMD	76		20022401NAD	81		20210305NMD	27		20219501NE	343		20330301	468	
20020306ROD	76		20022401NED	81		20210306	26		20219501NM	38		20340301	468	
20020306VED	76		20022401NMD	81		20211001	28		20219501NM	343		20370301	468	
20020306VID	76		20022401ROD	81		20211001BLD	28		20220003	28		20390301	466	
20020501	438		20022401VED	81		20211001NED	28		20220003	180		20390301D	466	
20020501ACD	80		20022401VID	81		20211002	28		20220003AC	28		20392001	469	
20020501AMD	80		20024501	400		20211002BLD	28		20220003AC	180		20392001D	469	
20020501BLD	80		20024501	416		20211002NED	28		20220003BM	28		20410301	478	
20020501BMD	80		20026010	438		20212001	29		20220003BM	180		20410301D	478	
20020501FUD	80		20031201	352		20212001ACD	29		20220003NM	28		20412001	478	
20020501NAD	80		20044001	171		20212001BLD	29		20220003NM	180		20412001D	478	
20020501NED	80		20044001AC	171		20212001BMD	29		20220004	28		20416701	478	
20020501NMD	80		20044001AM	171		20212001D	29		20220004	180		20417001	478	
20020501ROD	80		20044001BL	171		20212001INED	29		20220004AC	28		20417701	479	
20020501VED	80		20044001FU	171		20212001NMD	29		20220004AC	180		20417702	395	
20020501VID	80		20044001NA	171		20212002	29		20220004BM	28		20418001	479	
20020502	438		20044001NE	171		20212002D	28		20220004BM	180		20418002	395	
20020502ACD	80		20044001RO	171		20212101	35		20220004NM	28		20418002	479	
20020502AMD	80		20044001VE	171		20212101AC	35		20220004NM	180		20418080	479	
20020502BLD	80		20044001VI	171		20212101BM	36		20224501	400		20419601	369	
20020502BMD	80		20044002	173		20212101NM	36		20231201	38		20419601	480	
20020502FUD	80		20044002AC	173		20212102	35		20231201	351		20419601	488	
20020502NAD	80		20044002AM	173		20212103	35		20238501	39		20419602	363	
20020502NED	80		20044002BL	173		20212103AC	35		20238501	347		20419603	369	
20020502NMD	80		20044002BM	173		20212103BM	35		20238502	38		20419603	480	
20020502ROD	80		20044002FU	173		20212103NM	35		20238502	353		20419603	488	
20020502VED	80		20044002NA	173		20212104	35		20236304	156		20438501	364	
20020502VID	80		20044002NE	173		20212104	35		20236305	156		20438501	481	
20020503	438		20044002NM	173		20212104	35		20236307	156		20438501	489	
20020503ACD	80		20044002RO	173		20212104	35		20236308	156		20438701	362	
20020503AMD	80		20044002VE	173		20212104	35		20236309	156		20438701	481	
20020503BLD	80		20044002VI	173		20212104	35		20236311	156		20438701	488	
20020503BMD	80		20047501	572		20212104	35		20236312	156		20438702	360	
20020503FUD	80		20050301	424		20212104	35		20236313	156		20438702	480	
20020503NAD	80		20050301	438		20212104	35		20263901	333		20438703	362	
20020503NED	80		20050301AC	78		20212104	35		20263901	342		20438703	480	
20020503NMD	80		20050301BM	78		20212104	35		20263901AC	333		20438703	368	
20020503ROD	80		20050301NM	78		20212104	35		20266101	35		20438704	446	
20020503VED	80		20063604	160		20212104	35		20266102	35		20439501	360	
20020503VID	80		20063605	160		20217001	30		20298001	34		20510301	446	
20020504	437		20063606	160		20217001AC	30		20298001AC	34		20510301D	446	
20020504ACD	79		20063607	160		20217001BL	30		20298001BM	34		20510303	446	
20020504AMD	79		20063608	160		20217001BMD	30		20298001NM	34		20510305	534	
20020504BLD	79		20063609	161		20217001BL	30		20310301	466		20511201	447	
20020504BMD	79		20063610	160		20217001NE	30		20310301D	466		20511202	447	
20020504FUD	79		20063611	160		20217001NMD	30		20310303	466		20512001	447	
20020504NAD	79		20063612	160		20217409	36		20310303	466		20512001D	447	
20020504NED	79		20063613	161		20217409AC	37		20310303D	466		20512002	447	
20020504NMD	79		20116701	288		20217409BL	37		20312001	469		20516101	397	
20020504ROD	79		20117001	288		20217409BM	36		20312001D	469		20516103	397	
						20217409NE	37		20312003	469		205164019	368	

Ref.	€	Pág.	Ref.	€	Pág.	Ref.	€	Pág.	Ref.	€	Pág.	Ref.	€	Pág.
205164019	449		20635201BM	107		20725209	199		20735202RO	86		21027313NM	306	
20516701	447		20635201BM	244		20725210	196		20735202VE	86		21027391	298	
20517001	447		20635201NM	107		20725210AC	197		20735202VI	86		21027399	298	
205174019	370		20635201NM	244		20725210BM	197		20735203	205		21110301	91	
205174019	449		20635202	108		20725210NM	197		20735204	206		21110301ACD	91	
20517701	447		20635202	245		20725291	192		20735204AC	206		21110301BMD	91	
20517702	390		20635202AC	108		20725292	192		20735204BM	206		21110301D	91	
20518001	447		20635202AC	245		20725299	190		20735204NM	206		21110301NMD	91	
20518002	390		20635202BM	108		20725301	214		20735205	208		21110302	90	
20518002	448		20635202BM	245		20725302	214		20735206	211		21110302ACD	90	
20518003	391		20635202NM	108		20725302AC	215		20735207	211		21110302BMD	90	
20518003	448		20635202NM	245		20725302BM	215		20735208	210		21110302D	90	
20518004	391		20635203	246		20725302NM	215		20735208AC	210		21110302NMD	90	
20518005	391		20635203AC	247		20725303	216		20735208BM	210		21110501	94	
20518080	448		20635203BM	247		20725303AC	217		20735208NM	210		21110501AC	94	
20518201	584		20635203NM	247		20725303BM	217		20735209	209		21110501BM	94	
20518301	586		20635204	109		20725303NM	217		20735210	204		21110501NM	94	
20520001	530		20635204	247		20725304	220		20735210AC	205		21110502	94	
20520001AC	181		20635204AC	199		20725305	223		20735210BM	205		21110502AC	94	
20520002	531		20635204AC	248		20725305AC	223		20735210NM	205		21110502BM	94	
20520002AC	181		20635204BM	109		20725306	224		20735211	207		21110502NM	94	
20520041	530		20635204BM	248		20725307	224		20735212	207		21112001	98	
20520041AC	181		20635204NM	109		20725309	215		20735291	193		21112001ACD	98	
20520071	531		20635204NM	248		20725309AC	216		20735292	193		21112001BMD	98	
20520071AC	181		20635291	239		20725309BM	216		20735299	190		21112001D	98	
20522201	439		20635299	236		20725309NM	216		20735301	225		21112001NMD	98	
20522201	546		20635301	251		20725311	217		20735302	225		21112002	98	
20522201	439		20635301AC	250		20725311AC	218		20735302AC	226		21112002ACD	98	
20522201	546		20635301BM	250		20725311BM	218		20735302BM	226		21112002BMD	98	
20531201	352		20635301NM	250		20725311NM	218		20735302NM	226		21112002D	98	
20538501	346		20635302	252		20725312	219		20735303	229		21112002NMD	98	
20539501	346		20635302AC	252		20725313	219		20735304	229		21115101	97	
20544001	172		20635302BM	252		20725391	212		20735305	232		21115101AC	97	
20544001AC	172		20635302NM	252		20725392	212		20735306	233		21115101BM	97	
20544001BM	172		20635391	239		20725399	191		20735307	234		21115101NM	97	
20544001NM	172		20635399	237		20725401	221		20735308	233		21115201	97	
20548601	170		20635491	239		20725402	220		20735308AC	233		21115201AC	97	
20548601AC	170		20635499	237		20725403	222		20735309	226		21115201BM	97	
20548601BM	170		20718107	602		20725404	222		20735309AC	227		21115201NM	97	
20548601NM	170		20718201	257		20725491	212		20735309BM	227		21116101	104	
20548701	176		20718201	298		20725492	212		20735309NM	227		21116101AC	104	
20548701AC	176		20718201	337		20725499	191		20735310	227		21116101BM	104	
20548701BM	176		20718202	191		20735191	193		20735311	228		21116101NM	104	
20548701NM	176		20718202	237		20735192	193		20735312	218		21116103	104	
20549501	342		20718202	337		20735199	190		20735391	232		21116103BM	104	
20560301	536		20719201	200		20735201	71		20735392	213		21116103NM	104	
20560302	536		20719201AC	201		20735201	202		20735399	191		21116103NM	104	
20625191	238		20719201BM	201		20735201AC	71		20735401	230		21116409	105	
20625199	236		20719201NM	201		20735201AC	203		20735402	232		21116409AC	105	
20625201	240		20725191	192		20735201BM	71		20735403	230		21116409BM	105	
20625201AC	240		20725192	192		20735201NM	203		20735404	231		21116409NM	105	
20625201BM	240		20725199	190		20735201NM	71		20735491	213		21116701	98	
20625201NM	240		20725201	194		20735201NM	203		20735492	213		21116701AC	98	
20625202	241		20725201AC	194		20735201TAM	71		20735499	191		21116701BM	98	
20625202AC	241		20725201BM	194		20735201TAM	203		20739201	208		21116701NM	98	
20625202BM	241		20725201NM	194		20735201TBL	71		20739201AC	209		21117001	99	
20625202NM	241		20725202	39		20735201TBL	203		20739201BM	209		21117001AC	99	
20625203	243		20725202	195		20735201TFU	71		20739201NM	209		21117001BM	99	
20625203AC	243		20725202AC	40		20735201TFU	203		2117001NM	209		2117001NM	99	
20625203BM	243		20725202AC	53		20735201TNA	71		2117409	105		2117409	105	
20625203NM	243		20725202AC	196		20735201TNA	203		21018107	602		21117409AC	105	
20625204	242		20725202BL	40		20735201TNE	71		21027301	299		21117409BM	105	
20625204AC	242		20725202BL	53		20735201TNE	203		21027301AC	299		21117409NM	105	
20625204BM	242		20725202BL	195		20735201TRO	71		21027301BM	299		21117701	99	
20625204NM	242		20725202BM	40		20735201TRO	203		21027301NM	299		21118001	99	
20625291	238		20725202BM	53		20735201TVE	71		21027302	300		21118003	103	
20625299	236		20725202NE	196		20735201TVE	203		21027303	300		21118003AC	104	
20625301	249		20725202NE	40		20735201TVI	71		21027304	301		21118003BM	104	
20625301AC	249		20725202NE	53		20735201TM	203		21027305	301		21118003NM	104	
20625301BM	249		20725202NE	195		20735202	72		21027306	303		21118080	100	
20625301NM	249		20725202NM	40		20735202	203		21027307	303		21118080AC	100	
20625302	250		20725202NM	53		20735202AC	86		21027308	302		21118080BM	100	
20625391	238		20725202NM	196		20735202AC	204		21027309	302		21118080NM	100	
20625399	237		20725203	197		20735202AM	86		21027311	304		21120001	95	
20625491	238		20725204	198		20735202BM	86		21027311AC	305		21120001AC	95	
20625499	237		20725204AC	198		20735202BM	204		21027311BM	305		21120001BM	95	
20635191	239		20725204BM	198		20735202FU	86		21027311NM	305		21120002	95	
20635199	236		20725204NM	198		20735202NA	86		21027312	305		21120002AC	95	
20635201	107		20725205	200		20725202NE	86		21027313	306		21120002ACD	95	
20635201	244		20725206	201		20725202NE	86		21027313AC	306		21120002BMD	95	
20635201AC	107		20725207	202		20725202NM	86		21027313AC	306		21120002NM	95	
20635201AC	244		20725208	199		20725202NM	204		21027313BM	306		21120080	96	

LISTADO DE REFERENCIAS

Ref.	€	Pág.	Ref.	€	Pág.	Ref.	€	Pág.	Ref.	€	Pág.	Ref.	€	Pág.
21120080AC	96		21180302BMD	90		24218001	119		26110501NM	59		26215001		67
21120080BM	96		21180302NMD	90		24218001AC	119		26110502	59		26217790		64
21120080NM	96		21190401	92		24218001LV	119		26110502AC	59		26217792		64
21120081	96		21190401ACD	92		24218001OR	119		26110502BM	59		26217793		65
21120081AC	96		21190401BMD	92		24218003	119		26110502NM	59		26218003		67
21120081BM	96		21190401NMD	92		24218003AC	119		26112001	62		26218003AC		67
21120081NM	96		21190501	92		24218003LV	119		26112001D	62		26218003BM		67
21120201	95		21190501ACD	92		24218003OR	119		26115001	67		26218003NM		67
21120201AC	95		21190501BMD	92		24218004	120		26116209	69		26218003TAM		67
21120201BM	95		21190501NMD	92		24218004AC	120		26116209AC	69		26218003TBL		67
21120201NM	95		21190601	92		24218004LV	120		26116209BM	69		26218003TFU		67
21120202	95		21190601ACD	92		24218004OR	120		26116209NM	69		26218003TNA		67
21120202AC	95		21190601BMD	92		24218005	120		26116701	63		26218003TNE		67
21120202BM	95		21190601NMD	92		24218005AC	121		26116701AC	63		26218003TRO		67
21120202NM	95		21198091	99		24218005LV	121		26116701BM	63		26218003TVE		67
21120203	95		21198091AC	100		24218005OR	121		26116701NM	63		26218003TVI		67
21120203AC	95		21198091BM	100		24218006	122		26116701TAM	63		26218004		602
21120203BM	95		21198091NM	100		24218006AC	122		26116701TBL	63		26218005		66
21120203NM	95		21198092	101		24218006LV	122		26116701TFU	63		26218006		64
21120281	96		21198092AC	101		24218201	117		26116701TNA	63		26218009		66
21120281AC	96		21198092BM	101		24218201AC	118		26116701TNE	63		26218009AC		66
21120281BM	96		21198092NM	101		24218201LV	118		26116701TRO	63		26218009BM		66
21120281NM	96		21198093	101		24218201OR	118		26116701TVE	63		26218009NM		66
21120282	96		21198093AC	102		24219401	124		26116701TVI	63		26220050		61
21120282AC	96		21198094	103		24219401AC	124		26117001	63		26220050AC		61
21120282BM	96		21198094AC	103		24219401LV	124		26117001AC	63		26220050BM		61
21120282NM	96		21198099	102		24219401OR	124		26117001BM	63		26220050NM		61
21120283	96		21198099AC	102		24219402	123		26117001NM	63		26220050TAM		61
21120283AC	96		21198099BM	102		24219402AC	123		26220050TBL	63		26220050TBL		61
21120283BM	96		21198099NM	102		24219402LV	123		26220050TBU	63		26220050TFU		61
21120283NM	96					24219403	125		26220050TNA	61		26220050TNE		61
21120301	91		24210301	114		24219403AC	125		26220050TRO	61		26220050TNE		61
21120301ACD	91		24210301AC	114		24219403LV	125		26220050TVE	61		26220050TRO		61
21120301BMD	91		24210301LV	114		24219501	127		26220050TVI	61		26220080		61
21120301NMD	91		24210301OR	114		24219501AC	127		26220080AC	61		26220080AC		61
21120302	90		24210301OR	114		24219501LV	127		26220080BM	61		26220080BM		61
21120302ACD	90		24212001	115		24219502	126		26220080NM	61		26220080NM		61
21120302BMD	90		24212001AC	115		24219502AC	127		26220080TAM	61		26220080TAM		61
21120302NMD	90		24212001LV	115		24219502LV	127		26220080TBL	61		26220080TBL		61
21120501	93		24212001OR	115		24219801	128		26220080TFU	61		26220080TFU		61
21120501ACD	93		24214501	123		24219801AC	128		26220080TNA	61		26220080TNE		61
21120501BM	93		24214501AC	123		24219801LV	128		26220080TRO	61		26220080TVE		61
21120501NMD	93		24214501LV	123		24220001	114		26220080TVE	61		26220080TVI		61
21122401	98		24214501OR	123		24220001AC	114		26220080TVI	61		26222402		62
21122401ACD	98		24216402	126		24220001LV	114		26222402ACD	62		26222402BMD		62
21122401BMD	98		24216402AC	126		24220001OR	114		26222402NMD	62		26222402TAM		62
21122401NMD	98		24216402LV	126		24235201	129		26222402TRO	62		26222402TFU		62
21130501	93		24216409	124		24235201AC	130		26222402TNE	62		26222402TVE		62
21130501ACD	93		24216409AC	124		24235201LV	130		26222402TVD	62		26222402TVID		62
21130501BMD	93		24216409LV	124		24235201OR	130		26222402TVID	62		26222402TVID		62
21130501NMD	93		24216409OR	124		24235202	129		26222402TVID	62		26222402TVID		62
21131201	106		24216701	115		24235202AC	129		26222402TVID	62		26222402TVID		62
21131201AC	351		24216701AC	115		24235202LV	129		26222402TVID	62		26222402TVID		62
21139501	105		24216701LV	115		24235202OR	129		26222402TVID	62		26222402TVID		62
21139501AC	345		24216701OR	115		24235203	131		26222402TVID	62		26222402TVID		62
21139501ACD	106		24217001	115		24235203AC	131		26222402TVID	62		26222402TVID		62
21139501AC	345		24217001AC	115		24235203LV	131		26222402TVID	62		26222402TVID		62
21139502	106		24217001LV	115		24235301	130		26222402TVID	62		26222402TVID		62
21139502AC	346		24217001OR	115		24235301AC	130		26222402TVID	62		26222402TVID		62
21140501	93		24217301	114		24235301LV	130		26222402TVID	62		26222402TVID		62
21140501ACD	93		24217301AC	114		24235301OR	130		26222402TVID	62		26222402TVID		62
21140501BMD	93		24217301LV	114		24247601	116		26222402TVID	62		26222402TVID		62
21140501NMD	93		24217301OR	114		24247601AC	117		26222402TVID	62		26222402TVID		62
21150301	94		24217302	114		24247601LV	117		26222402TVID	62		26222402TVID		62
21175101	97		24217302AC	114		24247602	116		26222402TVID	62		26222402TVID		62
21175101AC	97		24217302LV	114		24247602AC	116		26222402TVID	62		26222402TVID		62
21175101BM	97		24217302OR	114		24247602LV	116		26222402TVID	62		26222402TVID		62
21175101NM	97		24217409	124		24247602OR	116		26222402TVID	62		26222402TVID		62
21175201	97		24217409AC	124		24273201	117		26222402TVID	62		26222402TVID		62
21175201AC	97		24217409LV	124		24273201AC	332		26222402TVID	62		26222402TVID		62
21175201BM	97		24217409OR	124		24273201LV	332		26222402TVID	62		26222402TVID		62
21175201NM	97		24217609	125		24273201OR	117		26222402TVID	62		26222402TVID		62
21175301	97		24217609AC	125		24273201LV	332		26222402TVID	62		26222402TVID		62
21175301AC	97		24217609LV	125		24287101	125		26222402TVID	62		26222402TVID		62
21175301BM	97		24217701	118		24287101AC	125		26222402TVID	62		26222402TVID		62
21180301	91		24217701	118		24287101LV	125		26222402TVID	62		26222402TVID		62
21180301ACD	91		24217701LV	118		24287101OR	125		26222402TVID	62		26222402TVID		62
21180301BMD	91		24217701OR	118					26222402TVID	62		26222402TVID		62
21180301NMD	91		24217703	121					26222402TVID	62		26222402TVID		62
21180302	90		24217703AC	121		26110501	59		26222402TVID	62		26222402TVID		62
21180302ACD	90		24217703LV	121		26110501D	59		26222402TVID	62		26222402TVID		62
						26110501BM	59		26222402TVID	62		26222402TVID		62

Ref.	€	Pág.	Ref.	€	Pág.	Ref.	€	Pág.	Ref.	€	Pág.	Ref.	€	Pág.	
26230801TVID	57		29911351	575		29997101		314	5291240361		136	913463320		600	
26231201	70		29933703	326		29997201		313	53			913463330		600	
26231201	353		29933703LV	326						53049603	168		9134672501		610
26247001	68		29943204	329		40				53049703	169		9134673501		610
26247001AC	68		29951501	580		406486	168			53049803	169		9134673503		610
26247001BM	68		29951502	580		406487	175			53210401	146		91346816		609
26247001NM	68		29951503	580		406980	50			53212401	147		91346816		609
26247002	68		29951504	336		4071649	51			53212501C	147		91346825		609
26247002AC	68		29951505	336		407167	49			53212501F	147		91346826		609
26247002BM	68		29951506	336		40717002	50			53214501	149		91346838		609
26247002NM	68		29951507	336		4071749	52			53217601	148		9134712		582
26285301	60		29951607	317		407395	52			53234201	183		9134725		577
26285301AC	60		29952505	604		407395	344			53276501	147		9134731051		589
26285301BM	60		29953202	331		407934	562		53277101	147		9134735		587	
26285301NM	60		29953203	331		43			53315501C	151		913473810		579	
26285302	60		29953204	330					53315501F	151		913474410		601	
26285302AC	60		29953205	331			430497	169		53315701C	151		913474420		601
26285302BM	60		29961001	610		47			53431501F	151		913474430		601	
26285302NM	60		29961002	610					53431705	151		9134745051		598	
26290301	57		29961005	610			472440	500		53473201	138		9134746051		595
26290301ACD	57		29961006	611		50			53473201	148		91347800		608	
26290301BMD	57		29963103	577					53473201	332		913478907		608	
26290301D	57		29963105	576			50643703	176		53473203	148		913478908		608
26290301NM	57		29963106	576		50644003	169		53473203	332		91348001		604	
26290301TAMD	57		29963107	577		50648603	168		53484601	596		913480050		604	
26290301TBLD	57		29963108	575		50648703	175		531103451	598		913480810		579	
26290301TFUD	57		29963109	118		507164039	51		5616361653	159		913481810		578	
26290301TNAD	57		29963109	335		50716703	49		56184001	590		9134824		138	
26290301TND	57		29963109AC	118		5071700203	50		56184003	590		9134824051		345	
26290301TOD	57		29963109AC	335		507174039	52		56243703	177		9134824053		338	
26290301TVED	57		29963109LV	118		50744003	170		56244003	174		913482510		578	
26290301TVID	57		29963109LV	335		52			5424410201	174		9134828		582	
26290401	58		29963109OR	118					5424410203	174		91348280051		582	
26290401ACD	58		29963109OR	335			52412501C	135		561103451	598		9134830052		582
26290401BMD	58		29963201	325		52412501F	135		5616361653	159		9134830053		582	
26290401NM	58		29963201	324		5241450161	139		56184001	590		913483090		582	
26290401TAMD	58		29963202	342		52414601	139		56184003	590		9134832		138	
26290401TBLD	58		29963202	342		52415101	135		56243703	177		9134842051		345	
26290401TFUD	58		29963203	324		5241550161C	143		56244003	174		9134842053		338	
26290401TNAD	58		29963203	342		5241550161F	143		59			913482510		578	
26290401TND	58		29963204	342		5241570161F	143			59019401	142		9134828		582
26290401TOD	58		29963205	325		5241670161	136		60			9134830051		582	
26290401TVID	58		29963206	324		5241670361	136			606486	168		9134830052		582
26290402	58		29963211	324		5241700161	136			606487	175		913483090		582
26290402ACD	58		29963212	325		5241700361	136			606980	50		9134832		138
26290402BMD	58		29963901	585		52417301	138			6071649	51		913484026		597
26290402NM	58		29963902	326		524280701	137			60717002	50		9134841		585
26290402TAMD	58		29963910	610		524290701	137			6071749	52		9134848		585
26290402TBLD	58		29974802	576		52433401	178			607395	52		9134849		578
26290402TFUD	58		29974901	334		52433402	178			607395	344		9134867		582
26290402TNAD	58		29974901	342		52433403	178			607934	562		9134872		606
26290402TND	58		29974902	334		52434101	174			63			9134880		578
26290402TOD	58		29974903	334		52434103	174				630497	169		9134881	
26290402TVID	58		29974903	342		5243420161	183		910691403		355		9134887		583
26290402VED	58		29974904	334		5243420261	183		9107515		150		9134915		581
26290403	58		29974905	335		5243420361	183		9120063690		587		916110348		595
26290403ACD	58		29974906	335		524360151	162		91340112380		575		916119510		587
26290403BMD	58		29974906	342		524360351	162		913412390		575		9161515		580
26290403NM	58		29987001	371		524360451	163		913414580		605		916184060		595
26290403TAMD	58		29987001	605		524360551	162		913419503		355		918119503		355
26290403TBLD	58		29987002	371		524360651	162		913414580		605		918138503		355
26290403TFUD	58		29987002	605		524360751	163		913419503		355		918192105		587
26290403TNAD	58		29990301	320		5243630851	162		913414580		605		918719510		587
26290403TND	58		29990302	320		5243630951	162		913419503	355		918763690		157	
26290403TOD	58		29990303	320		5243631051	163		9134415	581					
26290403TVID	58		29990304	323		5243631251	162		9134450	578					
26290403VED	58		29990306	321		5243631351	163		9134450303	355					
26298091	65		29990307	321		5243631551	162		9134515	580					
26298091AC	65		29990308	321		52482401	138		9134525	604					
26298091BM	65		29995501	547		52482401	335		9134609	582					
26298091NM	65		29995501	315		52482401	335		913460910	582					
26298091TAM	65		29995502	315		52482403	335		913460912	582					
26298091TBL	65		29995501	315		5291030161	134		913460915	582					
26298091TFU	65		29995501	316		5291030361	134		913460920	582					
26298091TNA	65		29995501	318		5291040161	134		9134615	580					
26298091TNE	65		29995501	318		5291040361	134		91346816	609					
26298091TRO	65		29995501	319		5291050161	134		91346816	609					
26298091TVE	65		29996201	314		52910601	135		91346826	609					
26298091TVI	65		29996501	312		5291200161	136		91346838	609					
	29		29996601	312		5291200361	136		9134712	582					
			29997001	313		5291240161	136		9134725	577					

CONDICIONES GENERALES DE VENTA

Precios sin impuestos (sin IVA)

Precios

Los precios de esta tarifa, y cualquier anexo que publiquemos, deben considerarse "precios de venta recomendados para el cliente final antes de impuestos".

Los precios están sujetos a cualquier variación según las circunstancias del mercado, materias primas, mano de obra, impuestos, etc., facturándose los que rijan el día de la expedición.

Pedidos

Se considerarán condicionales y sujetos, por lo tanto, a nuestra consideración.

Diseño

Nuestros modelos podrán ser modificados por exigencias de diseño, sin previo aviso, siempre en beneficio del artículo.

La documentación fotográfica y/o el diseño técnico reproducidos en los listados, catálogos, folletos y demás instrumentos publicitarios tienen valor indicativo, por lo que el cliente no podrá acogerse a ellos en caso de posibles quejas por disconformidad o diferencia con los productos suministrados. Las reclamaciones referentes a la falta de conformidad de los productos suministrados deberán realizarse, como máximo, en los quince días siguientes a la entrega de la mercancía en su lugar de destino.

Plazo de entrega

Nuestros plazos de entrega son siempre aproximados y no nos hacemos responsables de las consecuencias de cualquier retraso.

Expedición de productos

La mercancía viajará a PORTES PAGADOS SIEMPRE QUE EL PEDIDO NETO IMPORTE UN MÍNIMO DE 150€, si la compra es inferior a esta cantidad, viajará a portes pagados también pero realizaremos un cargo en la factura de 6€ en concepto de transporte y gestión. Para las islas, si el importe del pedido asciende a un mínimo de 600€, la mercancía viajará a portes pagados, si no, viajará siempre a portes debidos. Informamos que nuestro departamento de Logística gestiona los pedidos de forma independiente y no acumula los mismos para alcanzar el importe mencionado.

El destinatario, comprobada, al recibo de la mercancía, el estado de la misma, indicando en el albarán del transportista, las posibles incidencias.

GARANTÍA

TRES COMERCIAL S.A.

Este producto está garantizado por TRES COMERCIAL S.A. ante eventuales defectos derivados del proceso de fabricación durante 2 años según la nueva Ley de Garantías aplicable desde Enero de 2007, con extensión voluntaria por parte de la firma de 3 años adicionales, totalizando 5 años a partir de la fecha de facturación.

• Exceptuando: acabados dorado, color, acero, cobre, latón envejecido, cromo mate, madera y otros acabados especiales, por estar vinculados a la agresión externa según la dureza y calcificación de las aguas, así como complementos, griferías electrónicas, columnas y griferías termostáticas, que en estos casos será de 2 años.



• Nuestro servicio de asistencia técnica cubrirá las incidencias durante el periodo de 2 años de las griferías electrónicas y columnas, si la disfunción esta provocada por un fallo imputable al proceso productivo.

• Para ejercer los derechos que ofrece esta garantía, será imprescindible la presentación de la factura de compra.

• Queda excluido de esta garantía los daños producidos por uso inadecuado, montaje defectuoso, desgaste natural, medios de mantenimiento inadecuados.

• La eventual reparación o sustitución de componentes del producto afectado, no extiende la ampliación de la Garantía.

Una tarjeta con la garantía acompaña a cada modelo. Para que ésta garantía sea válida, es necesario en cada caso, la aceptación del defecto por nuestro departamento técnico. Nuestra garantía cubre únicamente la reposición del material sin cargo alguno, y sin que en ningún caso podamos hacernos responsables de los daños y perjuicios que por su defecto haya podido producirse directa o indirectamente, ni de los gastos de instalación.

Pago

El importe de las facturas, salvo acuerdos especiales, será cancelado mediante giro SEPA B2B, como máximo, a 30 días fecha factura.

Reserva de dominio

TRES comercial, S.A. será propietario de todos los productos suministrados al cliente, hasta el cobro completo de la factura correspondiente.

Jurisdicción

La buena fe que preside las relaciones de TRES COMERCIAL, S.A. con todos sus clientes y nuestro deseo de resolver todas las divergencias por vía amistosa, no hacen pensar como posibles las reclamaciones judiciales. No obstante, se prevé este improbable caso, sometiéndose ambas partes a los tribunales de Barcelona con renuncia expresa a cualquier otro fuero.

Aceptación condiciones

Todo pedido recibido, implica la aceptación formal de estas condiciones a menos de haber convenido otras por escrito.

MUY IMPORTANTE

Devoluciones

TRES no aceptará ninguna devolución de mercancía, sin que previamente nuestro Representante la haya aceptado y comunicado.

- 1) TRES NO ACEPTA NINGUNA DEVOLUCIÓN sin la aceptación previa. (La mercancía se devolverá al remitente)
- 2) TRES NO ACEPTA NINGUNA DEVOLUCIÓN de mercancía que pueda repararse con **Recambios Originales**.
- 3) TRES NO ACEPTA NINGUNA DEVOLUCIÓN de mercancía fuera de garantía.
- 4) No obstante, en caso de recepcionar mercancía perfectamente encajada, esta sufrirá una depreciación en factura de:

- Si es del año en curso -15% depreciación
- Si es anterior a dos años -30% depreciación
- Si es anterior a 3 años -60% depreciación

Los envíos de mercaderías deberán efectuarse a portes pagados por el cliente.



Pinturas ecológicas libres de disolventes
PEDIDO ESPECIAL - Plazo de entrega 3 semanas



Negro mate



Blanco mate



Negro



Negro-cromo



Blanco



Blanco-cromo



Ámbar



Ámbar-cromo



Naranja



Naranja-cromo



Rojo



Rojo-cromo



Violeta



Violeta-cromo



Fucsia



Fucsia-cromo



Verde



Verde-cromo



Acero



Latón viejo



Oro | Chapado en Oro 24K



Cobre



Inox



Cromo



Anodizado

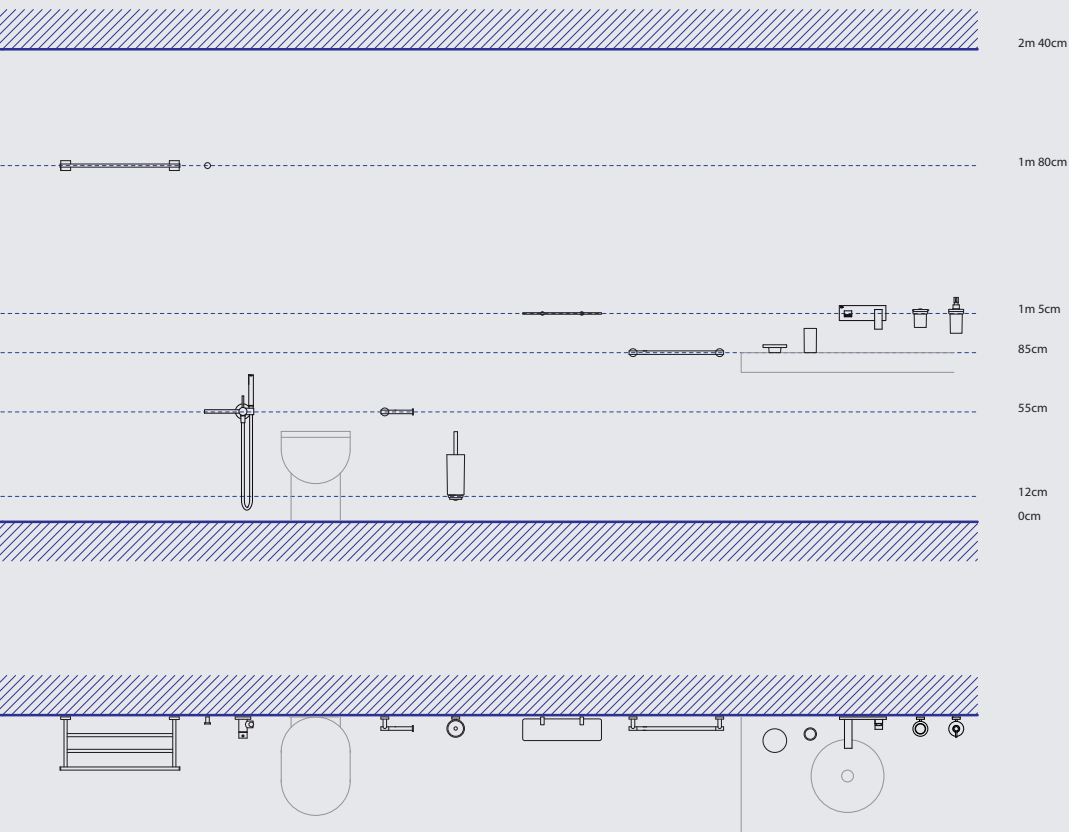

INFORMACIONES

Desagües ducha

En la ducha, se podrán utilizar dos salidas de agua al mismo tiempo siempre que el desagüe esté calculado para ello (Recomendamos el desagüe Ref: 1.04.B40).

Suministro de agua

Diferentes productos necesitan distintas presiones con distintos caudales, pero con una presión dinámica de entre 2 y 3 bar sería suficiente. La presión dinámica se mide con el grifo abierto.

Grifería empotrada

Estos productos empotrados tienen la gran ventaja de ganar espacio en duchas pequeñas y son más fáciles de limpiar.



TRES

C/ Penedès, 16-26
Zona Industrial, Sector A
08759 VALLIRANA (Barcelona)

TEL. (34) 93 683 40 04
FAX. (34) 93 683 50 61

Servicio de Atención al Cliente
TEL. (34) 93 683 40 27
comercialtres@tresgriferia.com

www.tresgriferia.com



ER-11111999



REF. 7342018010 / ED. 01-2018